

CATALOGUE 2024



OPEN UP POSSIBILITIES

Choose your favourite door from our range

4 ELEMENTS



4 ELEMENTS
/ AIR
str. 14



4 ELEMENTS
/ WATER
str. 16



4 ELEMENTS
/ FIRE
str. 18



4 ELEMENTS
/ EARTH
str. 20

HIDDEN DOORS



PORTA HIDE
str. 24

PAINTED DOORS



PORTA VECTOR
Premium
str. 28



PORTA FOCUS
Premium
str. 34



PORTA DUO
str. 36



PORTA DESIRE
str. 38



PORTA GRANDE
str. 40



VIENNA
str. 44

LOFT STYLE DOORS



PORTA GLASS
str. 48



PORTA LUMIA
str. 50



PORTA VERTE
HOME BLACK
str. 52



PORTA LOFT
STEEL
str. 54



PORTA CPL
str. 100

VENERED FRAME DOORS



PORTA VERTE
HOME G
str. 78



PORTA HARMONY
str. 62



PORTA VERTE
PREMIUM E
str. 70



CORDOBA
str. 128



PORTA INSPIRE
str. 64



PORTA VERTE
HOME M
str. 76

VENERED PANEL DOORS



PORTA UNI
COLOR MODERN
str. 86



PORTA LOFT
str. 92



PORTA LEVEL
str. 94



PORTA NOVA
str. 96



PORTA LINE
str. 98



PORTA DECOR
str. 104

Table of Contents

01 4 ELEMENTS DOORS	
●●●	4 Elements AIR..... 14
●●●	4 Elements WATER..... 16
●●●	4 Elements FIRE..... 18
●●●	4 Elements EARTH..... 20
02 HIDDEN DOORS	
●●●	PORTA HIDE TOP COLLECTIONS 24
03 PAINTED DOORS	
●●●	PORTA VECTOR Premium TOP COLLECTIONS 28
●●●	PORTA ART DECO NEW 30
●●●	PORTA OSLO 32
●●●	PORTA FOCUS Premium TOP COLLECTIONS 34
●●●	PORTA DUO 36
●●●	PORTA DESIRE TOP COLLECTIONS 38
●●●	PORTA GRANDE TOP COLLECTIONS 40
●●○	PORTA FACTOR NEW 42
●○○	PORTA ROYAL, LONDON, VIENNA NEW 44
●○○	MINIMAX 46
04 LOFT STYLE DOORS	
●●●	PORTA GLASS 48
●●○	PORTA LUMIA, NATURE LUMIA NEW 50
●●○	PORTA VERTE HOME BLACK 52
●●●	PORTA LOFT STEEL NEW 54
05 VENERED FRAME INTERIOR DOORS	
●●●	PORTA CONCEPT, group A TOP COLLECTIONS 56
●●●	PORTA CONCEPT, group C TOP COLLECTIONS 58
●●●	PORTA CONCEPT, group H and K 60
●●●	PORTA BALANCE, PORTA HARMONY 62
●●●	PORTA INSPIRE 64
●●○	PORTA VERTE PREMIUM, group A and D 66
●●○	PORTA VERTE PREMIUM, group B and C 68
●●○	PORTA VERTE PREMIUM, group E TOP COLLECTIONS 70
●●○	PORTA VERTE HOME, Group B and D 72
●●○	PORTA VERTE HOME, group C TOP COLLECTIONS 74
●○○	PORTA VERTE HOME, Group E and M NEW 76
●○○	PORTA VERTE HOME, group G TOP COLLECTIONS 78
●○○	PORTA VERTE HOME, group H TOP COLLECTIONS 80
●○○	PORTA VERTE HOME, group J TOP COLLECTIONS 82
●○○	PORTA VERTE HOME, group L and N 84
06 VENERED PANEL INTERIOR DOORS	
●●●	PORTA UNI Colour MODERN NEW 86
●●●	PORTA RESIST TOP COLLECTIONS 88
●●●	PORTA FOCUS TOP COLLECTIONS 90
●●●	PORTA LOFT TOP COLLECTIONS 92
●●●	PORTA LEVEL 94
●●○	PORTA NOVA, group 2-5 96
●●○	PORTA LINE TOP COLLECTIONS 98
●●○	PORTA CPL TOP COLLECTIONS 100
●●○	INVESTMENT SET 102
●●○	Porta DECOR 104
●○○	PORTA FIT, PORTA STYLE 106
●○○	PORTA CPL BASIC, PORTA DECOR BASIC, PORTA VERTE BASIC NEW 108
07 DOORS IN NATURAL VENEER	
●●●	Nature CLASSIC 110
●●●	Nature VECTOR NEW MODELS 112
●●●	Nature LINE 114
●●●	Nature LOFT 116
●●●	Nature OSLO 118
●●●	Nature GRANDE 120
●●●	Nature SPACE 122
●●●	Nature CONCEPT 124
●●●	SEVILLA 126
●●●	MADRID, CORDOBA 128
●●●	Villadora RETRO 130
08 FOLDING DOORS, SLIDING	
●●●	Folding doors ALFA, BETA 134
●●●	PORTA sliding systems, ALU 136
●●●	Sliding systems COMPACT, FRAMELESS 138
●●●	Sliding systems BLACK, SLIDE, EFFECT 140
09 TECHNICAL DOORS	
●●●	Acoustic 27 dB, 32 dB 144
●●●	INNOVO 37 dB 146
●●●	SILENCE 37 dB, EI 30 TOP COLLECTIONS 148
●●●	INNOVO 42 dB 150
●●●	Acoustic 42 dB 152
●●●	Fire protection EI 30, EI 60 TOP COLLECTIONS 154
●●●	ENDURO TOP COLLECTIONS 156
●●●	PORTA 4th strength performance class 158
10 APARTMENT ENTRANCE DOORS	
●●○	AGATE, OPAL 160
●●○	EXTREME RC 2 162
●●○	Steel SECURE 164
●●○	QUARTZ 166
●●○	EXTREME RC 3 TOP COLLECTIONS 168
●●○	EXTREME RC 4 170
●○○	GRANITE class C 172
11 TECHNICAL STEEL DOORS	
●○○	Doors for utility rooms, storage rooms 176
●○○	Steel BASIC, Steel BASIC PLUS 178
●○○	Steel SOLID 180
●○○	Steel EI 30 PLUS, EI 60 PLUS 182
12 DOOR FRAMES	
●○○	MINIMAX, RENOVA 186
●○○	PORTA SYSTEM, PORTA SYSTEM GK / GLASS 188
●○○	PORTA SYSTEM ELEGANCE, PORTA SYSTEM ELEGANCE 90 degrees 190
●○○	PORTA SYSTEM with reversed rebate 192
●○○	LEVEL 194
13 STEEL DOOR FRAMES	
●○○	Steel BASIC NEW 196
●○○	Steel PORTA SYSTEM ELEGANCE, Steel PORTA SYSTEM 198
●○○	Adjustable, steel, non-rebated, Adjustable, Adjustable PS with "sharp edges" 200
●○○	Corner profile, non-rebated - LARGE 202
●○○	Corner profile - SMALL PLUS, LARGE 202
●○○	PROJECT BIS, PROJECT Premium® 204
14 ADDITIONAL SOLUTIONS	
●○○	Additional equipment, door frame extensions 206
●○○	Ventilation 209
15 ACCESSORIES	
●○○	AZURA accessories collection 211
●○○	Interior door handles 212
●○○	Heavy duty handles 217
●○○	Handles for entrance doors 218
●○○	Additional accessories 219
16 DIMENSIONS, ADDITIONAL INFORMATION	
●○○	Door installation dimensions 222
●○○	Door dimension tables 224
●○○	Technical drawings 233
●○○	Classification of PORTA finishes 234
●○○	Colour samples 235

Check the price category

●●● PREMIUM ●●○ OPTIMUM ●○○ BUDGET

MEANING OF THE SYMBOLS THAT DESCRIBES OUR PRODUCT'S FEATURES

Please note

TOP COLLECTIONS
The most popular PORTA collections.

NEW
New in the offer

 Mirror additional option

K **PORTA CONTRACT**
bespoke solution

Handle

 **TIP!** Buy Conveniently as a set of door leaf + door frame + handle

Parameters

While choosing the type of construction you determine, inter alia, endurance, stability and soundproofness of your door.

 **Anti-burglary**
RC 2 class, RC 3 class, C class.
Resistance to unpermitted opening

 **Fire resistance**
EI 30, EI 60
Ability to stop the fire for 30 or 60 minutes

 **Smoke control**
class Sa, S_{ag}
It defines door's tightness to smoke leakage

 **Acoustic insulation**
Rw 27dB D,25, Rw 32dB D,30, Rw 37dB D,35, Rw 42 dB D,35, Rw 42 dB D,40
It defines acoustic rating of a door

 **Strength performance class**
class 1, class 2, class 3, class 4
The performance levels in resisting various loads indicating normal usage for a range of categories of duty.

 **AQUA STOP**
lower edge protection against humidity in TechnoPORTA technology

 **TechnoPORTA TECHNOLOGY**

Door frame

A door frame is as important part of a door set as a door leaf. There are a lot of door frame types and choosing one, please consider that they may come in two options: rebated, non-rebated or with reversed rebate.

 non-rebated

 rebated

 reversed rebate

 Architraves available in two sizes: 60 mm and 80 mm

 Project BIS, Project Premium

 Door frame adjustment available

 Fixed

Door leaf

Door design may have different functional solutions depending on interior needs and functions.

 **Available sizes for a single door:**
min. '60', max. '110'

 **Available sizes for a double door:**
min. '90', max. '220'

 **Increased height**
door leaf '220'

 **door leaf thickness**

 **Sliding door leaf**

 **Reversible door**
right-left



Please note ...

WORTH TO KNOW

TIP! Buy Conveniently as a set of door leaf + door frame + handle

■ Before purchasing a door you need to decide on the opening direction

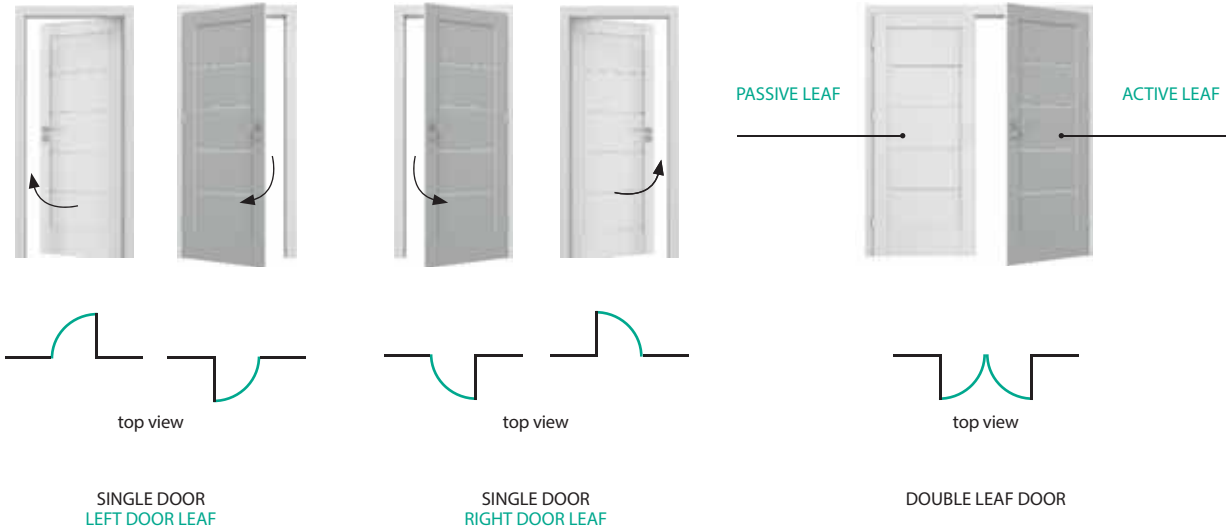

■ CALCULATE THE DOOR PRICE

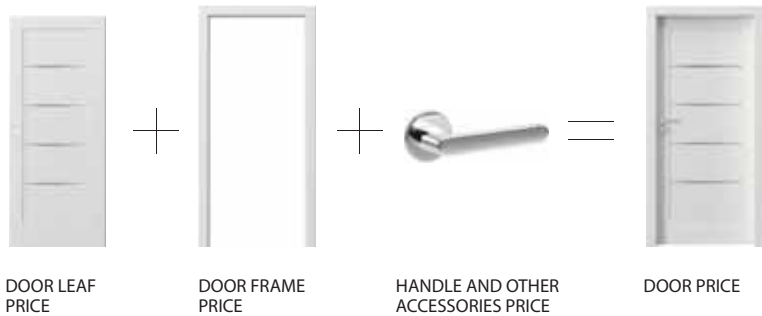

■ NEW DOOR LEAF HEIGHT „220”



New door leaf height 220 cm is available in chosen collections: 4 ELEMENTS, PORTA VECTOR, PORTA ART DECO, PORTA OSLO, PORTA DESIRE, Nature CLASSIC Nature LINE, Nature VECTOR, Nature OSLO.

UNI Colours / choose your favorite

Colour door in your interior! Subdued and calm colours make the proposed solutions fit into almost any interior. Modern, subtle shades of gray, green or beige. Choose your favorite colour.

NEW

CASHMERE MATT

Matt Lacquered Veneer

PORTA UNI COLOUR MODERN / p. 86
PORTA HIDE / p. 24

PLATINUM MATT

Matt Lacquered Veneer

PORTA UNI COLOUR MODERN / p. 86
PORTA HIDE / p. 24

GREY

Portadecor Veneer

Available in many collections
check out the product pages.

FIORD

Portadecor Veneer

AIR / p. 14
PORTA BALANCE / p. 62
PORTA HARMONY / p. 62

NEW

OLIVE

Portadecor Veneer

AIR / p. 14
PORTA BALANCE / p. 62
PORTA HARMONY / p. 62

GRAPHITE MATT

Matt Lacquered Veneer

PORTA UNI COLOUR MODERN / p. 86
PORTA HIDE / p. 24



Your favorite colour in your favorite style



CLASSIC / PORTA BALANCE, PORTA HARMONY, SEE P. 62 AIR, SEE P. 14



PORTA BALANCE
model A.0



PORTA BALANCE
model B.0



PORTA BALANCE
model B.1



PORTA BALANCE
model D.1



PORTA BALANCE
model D.2



PORTA BALANCE
model D.3



PORTA HARMONY
model A.0



PORTA HARMONY
model B.0



PORTA HARMONY
model B.2



PORTA HARMONY
model C.0



AIR model P.2



AIR model P.3

MODERN / PORTA UNI COLOUR MODERN; see p. 86



solid model



model 4.A



model H.1



model F.1



model L.1



model I.1



PORTA HIDE
see p. 24

Discover our wide range of classic doors!

Classic style interiors are a guarantee of timelessness, elegance and harmony.

Explore door models, dedicated door frames and accessories that will perfectly highlight the character of your interior.

Get inspired and create a unique interior.



AIR, model P.3

CHECK OUT OUR CLASSIC STYLE COLLECTIONS



PORTA ROYAL
model A



PORTA GRANDE
model A.1



PORTA NOVA
model 2.1



PORTA HARMONY
model B.0



Villadora RETRO
Residence 0 model



CORDOBA
large muntin



PORTA INSPIRE
model A.0

Choose timeless classics

CLASSIC



RETRO MODULE
see p. 207

ORTICA knob
see p. 216

MODERNO handle
see p. 216

LUNGO handle
see p. 207

WALL SLAT
see p. 207

Discover the values of our products

PORTA is a brand that has existed for over 30 years and is a leader in door production. During this time we have sold about 19 million products, and the experience we have gained has allowed us to perfect quality, durability and good design. The icons present the unique features of our products. Thanks to them, you will quickly find the product of your dreams. Look for them on catalogue cards.

Durable solutions



WOOD TEXTURE

Feel the texture of the wood. The Gladstone / Halifax finish resembles natural, raw wood.



DURABLE FINISH

The durable CPL laminate finish provides abrasion and scratch resistance.



SURFACE RESISTANT TO SCRUBBING

Unique quality at an affordable price! The surface of these doors is resistant to scrubbing.



NATURAL VENEER FINISH

Unique beauty. The Veneer finish of the door leaf looks beautiful and natural. It's a classic that is always in trend.



CERTIFIED CPL

CPL (Continuous Pressure Laminate) is a laminate known for its superior durability against mechanical damage. Only authentic CPL provides such properties. PORTA exclusively utilizes original laminates from reputable manufacturers, accredited by Research Institutes.



Matched to your interior



MATCH

Create a harmonious and comprehensive interior design by properly matching the Veneer. Match doors to floors and furniture



IN YOUR FAVORITE COLOURS

Match the door to your interior. PORTA offers a wide selection of veneers in many colours. You can easily fit them into any space.



MORE LIGHT

PORTA glazed doors will work well in rooms that need additional lighting, such as a vestibule, kitchen or home office.



PAINT IN YOUR FAVORITE COLOURS

Create your space on your own terms. Personalize the door as you like - paint, wallpaper or decorate with stucco.





Detail matters

ABS

DURABLE EDGE

The ABS-finished door leaf edge is resistant to scratches, mechanical damage, humidity, temperature differences and discoloration.

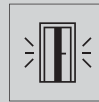

SAFETY LAMINATED GLASS

Choose a door with laminated safety glass. Thanks to the safety features, it will not fall apart if broken. We care about your safety!

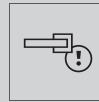

EVERY DETAIL MATTERS

The possibility of ordering personalized doors (many additions and accessories) will give your interior character.



AQUA STOP

AQUA STOP is a unique coating that protects the lower meeting edge type of the door leaf against water penetration.

Lacquer with quality guarantee



RECOMMENDED FOR ALLERGY SUFFERERS AND CHILDREN

Our doors do not contain harmful substances. They are recommended for people who are particularly sensitive, prone to allergies and children.

UV

DURABLE FINISH

The use of high-quality UV Paint to finish the door is a guarantee of many years of colour constancy.



SATIN SMOOTHNESS

The exceptional smoothness of the surface of these doors was achieved through the use of a suitable paint layer, materials and UV Paint light-hardening technology.



DURABLE FINISH

Extreme durability and smoothness of the door leaf coating thanks to the perfect paint layer.



DIRT-RESISTANT SURFACE

Doors with hardened paint are very easy to keep clean. With a stain-resistant surface, you can easily wash away stains from coffee, tea, wine, cola, grease, and even beetles!

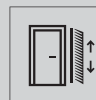

SURFACE RESISTANT TO SCRUBBING

Thanks to a thicker layer of paint, the surface of these doors is resistant to scrubbing.

Be your style!

YOUR INTERIOR, YOUR **ELEMENT**

**Are you looking for a door that fits you,
and designed by designers?**

We created the PORTA 4 ELEMENTS collection, inspired by nature, with you in mind.
The door models we offer fit into all the currently most popular interior styles.



FIRE O.1



AIR P.3



AIR P.3

**RECOM-
MENDED**



ALR collection P.3, height '220', Fiord, ORTICA knob gold



AIR collection P3, height '220', Fiord, ORTICA knob black



COLLECTION
DESIGNED AS A SET



PAINT
AS YOU LIKE



EVERY
DETAIL
MATTERS



model P1



model P2



model P3



ORTICA knob



skirting boards and wall slats,
see page. 207



TIP! Designed as a set with PORTA SYSTEM
ELEGANCE door frame WWWand ORTICA knob



version finished with white primer
Veneer, for self-painting

AVAILABLE FINISHES

Premium Plus UV Paint ♥♥♥♥♥



Primer Veneer / for self-painting



Portadecor Veneer ♥♥♥♥♥



Fiord colour is comparable with NCS: s 3010-b50g
Colour Olive is comparable with NCS S 6010-G10Y

TECHNICAL INFORMATION

DOOR LEAF CONSTRUCTION

Chipboard core reinforced with an inner stile. The construction is skinned with HDF.
Preparation for shortening, maximum 60 mm.

ACCESSORIES

- rebated door - three PRIME hinges in colours: silver or gold
- non-rebated 3D hinges in the following colours: silver, black/gold (option at extra charge)
- magnetic lock in the following colours: stainless steel or black/gold (option at extra charge) with height '220' three hinges as standard

DOOR FRAMES

Recommended rebated door frames:

- PORTA SYSTEM in primer Veneer or Premium Plus UV Paint p. 188

Recommended non-rebated door frames:

- PORTA SYSTEM ELEGANCE in primer Veneer or Fiord Veneer p. 190

NOTES

- Norm PN EN 14351-2:2018-12
- The Fiord and Olive colours are available only in the PORTA SYSTEM ELEGANCE door frame
- Hinges - packaged with door frame

EXTRA CHARGES

- size '100'
- door leaf height 220 cm
- ventilation undercut
- changing the silver magnetic lock to black
- changing the silver magnetic lock to gold
- non-rebated doors: third 3D hinge, gold (extra charge added to door frame price)
- non-rebated door leaves: 3D hinges, gold (extra charge added to door frame price)
- third 3D hinge silver / black
- handle with an escutcheon

(p. 213)

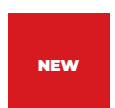
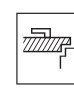
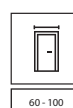
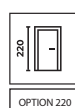



WATER W.2 collection, height '220'; MAXIMA CONNECT black handle with white insert



COLLECTION
DESIGNED AS A SET



DURABLE
FINISH



RECOMMENDED
FOR ALLERGY SUFFERERS
AND CHILDREN



EVERY DETAIL
MATTERS



DURABLE
FINISH



SATIN
SMOOTHNESS



model W.1



model W.2



MAXIMA CONNECT handle



milling model W.1



TIP! Design as a set with PORTA SYSTEM ELEGANCE 90° door frame and the MAXIMA CONNECT handle



decorative milling close up

AVAILABLE FINISHES

Premium Plus UV Paint ◆◆◆◆◆◇



created by
CX DESIGN TEAM

TECHNICAL INFORMATION

DOOR LEAF CONSTRUCTION

Chipboard core reinforced with an inner stile. The construction is skinned with HDF.
Preparation for shortening (maximum 60 mm).

ACCESSORIES

- 2 pc. of non-rebated 3D hinges in the following colours:
silver or black/white (option at extra charge)
- magnetic lock in the following colours: stainless steel or black/white (option at extra charge)
- with height '220' three hinges as standard

DOOR FRAMES

- PORTA SYSTEM ELEGANCE 90 degrees p. 190

NOTES

- Norm PN EN 14351-2:2018-12

EXTRA CHARGES

- size '100'
- door leaf height 220 cm
- ventilation undercut
- changing the silver magnetic lock to black or white
- third 3D hinge (extra charge added to a door frame price)
- handle with an escutcheon

(p. 213)

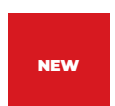
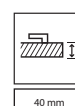
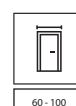
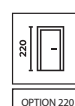



FIRE O.7 collection, Sherman Oak, PORTA SYSTEM ELEGANCE steel door frame, MAXIMA handle



COLLECTION
DESIGNED AS A SET



WOOD TEXTURE



INNOVATIVE LOCK
FOR LONG PULLS



ABS DURABLE EDGE



STEEL DOOR FRAME
WITHOUT VISIBLE
JOINTS



model O.1



model O.7



CARBON door pull

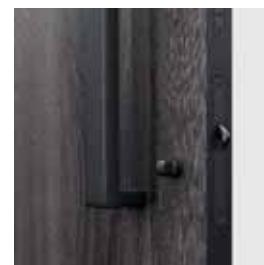

WC escutcheon with an additional lock



TIP! Designed as a set with PORTA SYSTEM ELEGANCE steel door frame and MAXIMA handle or CARBON pull

AVAILABLE FINISHES

Gladstone board ♥♥♥♥♥♥♥♥



AVAILABLE FINISHES OF THE DOOR FRAME

Premium Polyester Paint ♥♥♥♥♥◇◇



TECHNICAL INFORMATION

DOOR LEAF CONSTRUCTION

Chipboard core reinforced with an inner stile. The construction is skinned with HDF. Preparation for shortening (maximum 60 mm).

FINISH

The leaf sides are covered with ABS tape in black colour. Horizontal grain direction in model O.7. Black steel panels only in model O.7.

ACCESSORIES

- two non-rebated, 3D hinges in black
- key lock for steel door frame in black
- magnetic system in black for version with handle (option at extra charge)
- additional lock in magnetic system for WC option in black (option at extra charge)
- with height '220' three hinges as standard

DOOR FRAMES

- Steel PORTA SYSTEM ELEGANCE p. 199

NOTES

- Norm PN EN 14351-2:2018-12
- Height '220' available only in model O.1
- In the option with handle dedicated striker in the steel frame
- Hinges packaged with door frame

EXTRA CHARGES

- size '100'
- door leaf height 220 cm
- ventilation undercut
- magnetic system with a pull: extra charge added to a door frame price
- magnetic system with a pull: extra charge added to a door leaf price
- magnetic system with a door pull: CARBON pull
- additional lock in magnetic system for WC option
- third 3D hinge (extra charge added to a door frame price)
- handle with an escutcheon

(p. 213)

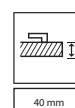
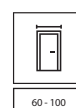
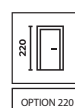



Earth Z.1 collection, height '220', Matt Oak, PORTA SYSTEM ELEGANCE 90° door frame, AZALIA black handle



COLLECTION
DESIGNED AS A SET



NATURAL VENEER
FINISH



EVERY DETAIL
MATTERS



model Z.1



model Z.1



geometric arrangement of Natural
Veneer, matt varnish, Azalia handle



geometric arrangement of Natural
Veneer, matt varnish, Azalia handle



TIP! Design as a set with PORTA SYSTEM ELEGANCE
90° door frame and Azalia handle.

AVAILABLE FINISHES

Natural Veneer Oak Mat ▼▼▼▼▼



AVAILABLE FINISHES OF THE DOOR FRAME

Natural Select Veneer ▼▼▼▼▼



Natural Veneer Oak Mat ▼▼▼▼▼



TECHNICAL INFORMATION

DOOR LEAF CONSTRUCTION

Chipboard core reinforced with an inner stile. Preparation for shortening (maximum 60 mm).

FINISH

The construction is skinned with a slim particle board which is finished with high quality Natural Veneer. The surface of the leaf is protected with environmentally friendly UV-hardened water-based varnishes.

ACCESSORIES

- two non-rebated, 3D hinges in the following colours: silver, black (option at extra charge)
- magnetic lock in the following colours: stainless steel or black (option at extra charge)
- with height '220' three hinges as standard

DOOR FRAMES

- PORTA SYSTEM ELEGANCE 90 degrees p. 190

NOTES

- Standard PN EN 14351-2:2018-12
- Hinges packaged with door frame

EXTRA CHARGES

- size '100'
- door leaf height 220 cm
- ventilation undercut
- changing the silver magnetic lock to black
- changing the silver magnetic lock to gold
- third 3D hinge (extra charge added to a door frame price)
- handle with an escutcheon

(p. 213)

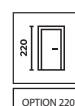

OPTION 220



60 - 100

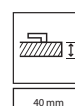

40 mm

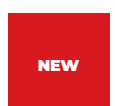

CONCEALED DOOR

02

→ Choose PORTA HIDE concealed doors, **design them according to your idea!**



ORDER IN
YOUR CHOICE OF
PORTA VENEER



ORDER
IN NATURAL
VENEER



PAINT IN YOUR
FAVORITE COLOUR

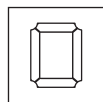

DECORATE
WITH WALL SLAT



COVER WITH
INTERESTING
WALLPAPER

 **TIP!** Shop CONVENIENTLY
as a set door + handle



Scan QR code
Discover PORTA Hide's
cameleon doors and
transform your interiors.





PORTA HIDE 1.1, Lorenzo Oak, white SIMPLE door handle



DURABLE FINISH



PAINT OR PASTE WALLPAPER AS YOU LIKE



RECOMMENDED FOR ALLERGY SUFFERERS AND CHILDREN



IN YOUR IN YOUR FAVORITE COLOURS



CERTIFIED CPL



model 1.1, Primer Paint



model 1.1, Lorenzo Oak



model 4.A, Lorenzo Oak



Non-rebated door leaf (outwards) - right door



Reversed rebate (opening inwards) - left door



AVAILABLE FINISHES

Premium UV Paint



Premium Plus UV Paint



Primer Paint



for self-painting and wallpapering

Portadecor Veneer



Portalamino

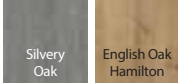

Matt Lacquered Veneer



Portaperfect 3D Veneer

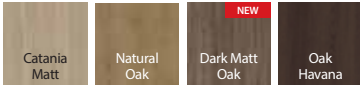

CPL HQ 0,2 laminate



Natural Oak Satin Veneer



Natural Select Veneer



Natural Veneer

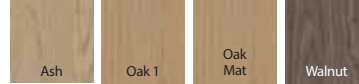

Ash and Walnut Veneer is available in a flower arrangement.

Gladstone / Halifax



TECHNICAL INFORMATION

DOOR LEAF CONSTRUCTION

Honeycomb or hollow core reinforced with rails and stiles (at extra charge). Model 4.A in Natural Veneer finishes available only with hollow chipboard core. The construction is skinned with HDF. Preparation for shortening for hollow chipboard core, maximum 60 mm.

DOOR FRAMES

Concealed aluminium door frame, ready for painting with wall paint or white lacquered. It's dedicated for 40 mm thick, wooden door leaves. Can be assembled on plasterboard wall. Dimensions see page. 224, Table 2.

DOORS INCLUDE

- Door leaf
- Two 3D hinges, dedicated for PORTA HIDE collection, three 3D hinges for hollow core
- Magnetic lock: key lock, WC lock or cylinder lock
- Concealed aluminum door frame

NOTES

- Norm PN EN 14351-2:2018-12
- automatic threshold seal in a door leaf with hollow chipboard core
- In a set with white door frame - white hinges and white lock strike
- Recuperative shortening and automatic threshold seal is not available for model 4.A

EXTRA CHARGES

CPL finish 0,2 mm - GROUP II hollow chipboard core ventilation undercut or recuperative shortcut automatic threshold seal handle with an escutcheon

(p. 213)

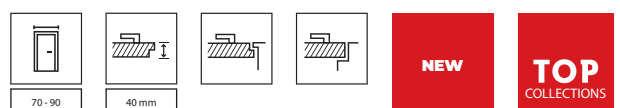

INTERIOR DOORS

→ Choose a door **according to your needs**



✓ **SOLID DOORS**

They will work well in rooms where **privacy and maximum soundproofing** play a big role (such as a home office, bedroom or teenager's room).



✓ **GLAZED DOORS THIS IS A PERFECT SOLUTION FOR DARK ROOMS.**

Frame and panel door models with smaller, frosted glass panels will allow you to keep privacy without sacrificing light. On the other hand, large glazings will give a loft character to the interior and optically enlarge the space.



✓ **PERSONALIZED DOORS**

In our offer you will find doors with a porthole, magnetic board, or mirror. Doors with millings or in the colour of your furniture are also an interesting solution.

 **TIP!** Buy CONVENIENTLY as a set of door leaf + door frame + handle





PORTA VECTOR Premium T, White, handle NEXT



DURABLE
Colour



STAIN-RESISTANT
SURFACE



RECOMMENDED
FOR ALLERGY SUFFERERS
AND CHILDREN



DURABLE
FINISH



SURFACE RESISTANT
TO SCRUBBING



SATIN
SMOOTHNESS



VECTOR T



VECTOR A



VECTOR B



VECTOR C



ELEGANT door handle



decorative milling close up



VECTOR E



VECTOR J



VECTOR U



VECTOR V

AVAILABLE FINISHES

Premium UV Paint ♥♥♥♥◇◇



Premium Plus UV Paint ♥♥♥♥◇◇



PLEASE NOTE

If you're looking for a glazed door that matches this collection, check PORTA FOCUS Premium see p. 34

K Give free rein to your imagination! Do you have your own door concept? You can order any milling with PORTA CONTRACT.

TECHNICAL INFORMATION

DOOR LEAF CONSTRUCTION

Honeycomb or hollow chipboard core reinforced with rails and stiles (at extra charge). The construction is skinned with HDF. Height '220': available models - A, B, C, E, T, U, V; core - hollow chipboard, 3 hinges as standard Size '100' and reinforcement for a door closer require third hinge.

ACCESSORIES

- rebated doors: two or three barrel hinges standard or PRIME.
- non-rebated and reversed rebate doors: two 3D hinges
- lock: key lock, WC lock, or cylinder lock
- oblong pull handle for sliding doors

DOOR FRAMES

Recommended rebated door frames:

- PORTA SYSTEM in Premium lacquered Veneer and in Premium Plus UV Paint p. 188
- MINIMAX in Premium lacquered Veneer and in Premium Plus UV Paint p. 186

Recommended non-rebated door frames:

- PORTA SYSTEM with reversed rebate finished with Premium lacquered Veneer or Premium Plus UV Paint see p. 190
- PORTA SYSTEM ELEGANCE 90 degrees in Premium lacquered Veneer and in Premium Plus UV Paint p. 190
- LEVEL in Premium lacquered Veneer and in Premium Plus UV Paint p. 194

Recommended door frames with reversed rebate:

- PORTA SYSTEM with reverse rebate in Premium lacquered Veneer and in Premium Plus UV Paint p. 192

NOTES

- Norm PN EN 14351-2:2018-12.
- Double doors are available in any door leaf size combinations.
- Magnetic lock is not available for a double door.
- There are two door leaves (active and passive, sizes 60-100) in double leaf doors.
- PRIME hinges or 3D hinges – packed with the door frame.

EXTRA CHARGES

- size '100'
- door leaf height 220 cm
- preparation for shortening (max. 60 mm)
- hollow chipboard core
- chipboard core
- ventilation sleeves or ventilation undercut or recuperation shortcut
- automatic threshold seal
- black lock and black barrel hinges
- magnetic lock with stainless steel faceplate
- magnetic lock: black and black barrel hinges (for rebated doors)
- magnetic lock: white, black (for non-rebated doors)
- magnetic lock: gold
- OFFER - prime set without extra charge
- non-rebated door leaves: third 3D hinge, silver, white, black (extra charge to the door frame price)
- non-rebated doors: third 3D hinge, gold (extra charge added to door frame price)
- non-rebated door leaves: 3D hinges, gold (extra charge added to door frame price)
- reversed rebate - extra charge added to door leaf price
- reversed rebate - third 3D hinge, white, black (extra charge added to door frame price)
- reversed rebate - third 3D hinge, silver (extra charge added to door frame price)
- reversed rebate - 3D gold hinges (extra charge added to door frame price)
- reversed rebate - third 3D hinge, gold (extra charge added to the door frame price)
- sliding door leaves - oblong pull handle
- sliding door leaves - hook lock with side pull handles
- reinforcement for a door closer requires third hinge handle with an escutcheon

(p. 213)

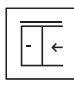
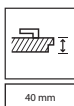
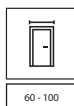
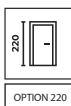



PORTA ART DECO 2, White, AZURA gold door handle



DURABLE
Colour



DIRT-RESISTANT
SURFACE



RECOMMENDED
FOR ALLERGY SUFFERERS
AND CHILDREN



DURABLE
FINISH



COATING RESISTANT
TO SCRUBBING



SATIN
SMOOTHNESS



model 1



model 2



AZURA door handle



decorative milling close up
model 1



model 3



model 4



decorative milling close up
model 2, 3, 4

AVAILABLE FINISHES

Premium UV Paint ♥♥♥♥◇◇



Premium Plus UV Paint ♥♥♥♥◇◇



TECHNICAL INFORMATION

DOOR LEAF CONSTRUCTION

Honeycomb or hollow chipboard core reinforced with rails and stiles (at extra charge). The construction is skinned with HDF. Height '220': core - hollow chipboard; 3 hinges as a standard. Size '100' and reinforcement for a door closer require third hinge.

ACCESSORIES

- rebated doors: two or three barrel hinges standard or PRIME.
- non-rebated and reversed rebate doors: two 3D hinges
- lock: standard lock option, with bathroom lock or cylinder lock
- oblong pull handle for sliding doors

DOOR FRAMES

Recommended rebated door frames:

- PORTA SYSTEM in Premium lacquered Veneer and in Premium Plus UV Paint p. 188
- MINIMAX in Premium lacquered Veneer and in Premium Plus UV Paint p. 186

Recommended non-rebated door frames:

- PORTA SYSTEM ELEGANCE in Premium lacquered Veneer and in Premium Plus UV Paint p. 190
- PORTA SYSTEM ELEGANCE 90 degrees in Premium lacquered Veneer and in Premium Plus UV Paint p. 190
- LEVEL in Premium lacquered Veneer and in Premium Plus UV Paint p. 194

Recommended door frames with reversed rebate:

- PORTA SYSTEM with reverse rebate in Premium lacquered Veneer and in Premium Plus UV Paint p. 192

NOTES

- Norm PN EN 14351-2:2018-12.
- Double doors are available in any door leaf size combinations.
- Magnetic lock is not available for a double door.
- There are two door leaves (active and passive, sizes 60-100) in double leaf doors.
- PRIME hinges or 3D hinges – packed with the door frame.

EXTRA CHARGES

- size '100'
- door leaf height 220 cm
- preparation for shortening (max. 60 mm)
- hollow chipboard core
- chipboard core
- ventilation sleeves or ventilation undercut or recuperation shortcut
- automatic threshold seal
- black lock and black barrel hinges
- magnetic lock with stainless steel faceplate
- magnetic lock: black and black barrel hinges (for rebated doors)
- magnetic lock: white, black (for non-rebated doors)
- magnetic lock: gold
- OFFER - prime set without extra charge
- non-rebated door leaves: third 3D hinge, silver, white, black (extra charge to the door frame price)
- non-rebated doors: third 3D hinge, gold (extra charge added to door frame price)
- non-rebated door leaves: 3D hinges, gold (extra charge added to door frame price)
- reversed rebate - extra charge added to door leaf price
- reversed rebate - third 3D hinge, white, black (extra charge added to door frame price)
- reversed rebate - third 3D hinge, silver (extra charge added to door frame price)
- reversed rebate - 3D gold hinges (extra charge added to door frame price)
- reversed rebate - third 3D hinge, gold (extra charge added to door frame price)
- sliding door leaves - oblong pull handle
- sliding door leaves - hook lock with side pull handles
- reinforcement for a door closer requires third hinge
- handle with an escutcheon

(p. 213)

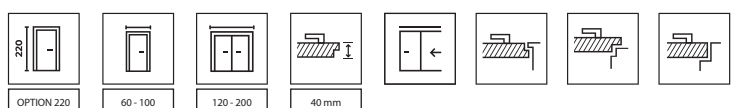



PORTA OSLO 1, White, DIVO FIT Q handle black



DURABLE FINISH



DIRT-RESISTANT SURFACE



RECOMMENDED FOR ALLERGY SUFFERERS AND CHILDREN



DURABLE FINISH



COATING RESISTANT TO SCRUBBING



SATIN SMOOTHNESS



model 1



model 2



model 3



AZALIA handle



decorative milling close up model 1,2

AVAILABLE FINISHES

Premium UV Paint ◆◆◆◆◇◇



Premium Plus UV Paint ◆◆◆◆◆◇



TECHNICAL INFORMATION

DOOR LEAF CONSTRUCTION

Honeycomb or hollow chipboard core reinforced with rails and stiles (at extra charge). The construction is skinned with HDF. Height '220': core - hollow chipboard; 3 hinges as a standard. Size '100' and reinforcement for a door closer require third hinge.

ACCESSORIES

- rebated doors: two or three barrel hinges standard or PRIME.
- non-rebated and reversed rebate doors: two 3D hinges
- lock: key lock, WC lock, or cylinder lock
- oblong pull handle for sliding doors

DOOR FRAMES

Recommended rebated door frames:

- PORTA SYSTEM finished with Premium lacquered Veneer or Premium Plus UV Paint, see p. 188
- MINIMAX in Premium lacquered Veneer and in Premium Plus UV Paint p. 186

Recommended non-rebated door frames:

- PORTA SYSTEM with reversed rebate finished with Premium lacquered Veneer or Premium Plus UV Paint see p. 190
- PORTA SYSTEM ELEGANCE 90 degrees in Premium lacquered Veneer and in Premium Plus UV Paint p. 190
- LEVEL in Premium lacquered Veneer and in Premium Plus UV Paint p. 194

Recommended door frames with reversed rebate:

- PORTA SYSTEM with reverse rebate in Premium lacquered Veneer and in Premium Plus UV Paint p. 192

NOTES

- Norm PN EN 14351-2:2018-12.
- Double doors are available in any door leaf size combinations.
- Magnetic lock is not available for a double door.
- There are two door leaves (active and passive, sizes 60-100) in double leaf doors.
- PRIME hinges or 3D hinges – packed with the door frame.

EXTRA CHARGES

- size '100'
- door leaf height 220 cm
- preparation for shortening (max. 60 mm)
- hollow chipboard core
- chipboard core
- ventilation undercut
- automatic threshold seal
- black lock and black barrel hinges
- magnetic lock with stainless steel faceplate
- magnetic lock: black and black barrel hinges (for rebated doors)
- magnetic lock: white, black (for non-rebated doors)
- magnetic lock: gold
- OFFER - prime set without extra charge
- non-rebated door leaves: third 3D hinge, silver, white, black (extra charge to the door frame price)
- non-rebated doors: third 3D hinge, gold (extra charge added to door frame price)
- non-rebated door leaves: 3D hinges, gold (extra charge added to door frame price)
- reversed rebate - extra charge added to door leaf price
- reversed rebate - third 3D hinge, white, black (extra charge added to door frame price)
- reversed rebate - third 3D hinge, silver (extra charge added to door frame price)
- reversed rebate - 3D gold hinges (extra charge added to door frame price)
- reversed rebate - third 3D hinge, gold (extra charge added to door frame price)
- sliding door leaves - oblong pull handle
- sliding door leaves - hook lock with side pull handles
- reinforcement for a door closer requires third hinge handle with an escutcheon

(p. 213)

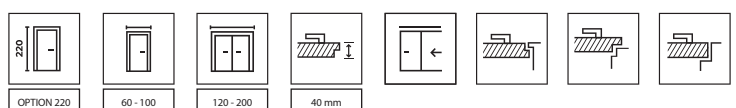



PORTA FOCUS Premium 4.A, White, ELEGANT handle, black



DURABLE
Colour



DIRT-RESISTANT
SURFACE



RECOMMENDED FOR
ALLERGY SUFFERERS
AND CHILDREN



SAFETY LAMINATED
GLASS



COATING RESISTANT
TO SCRUBBING



SATIN
SMOOTHNESS



PORTA FOCUS
model 5.A



PORTA FOCUS
model 5.B



PORTA FOCUS
model 5.C



PORTA FOCUS
model 4.A



OFFICE handle



glass - door panel joint
non-rebated door leaf



PORTA FOCUS
model 4.B



PORTA FOCUS
model 4.C



PORTA FOCUS
model 4.D



PORTA FOCUS
model 4.E



glass - door panel joint
rebated door leaf

AVAILABLE FINISHES

Premium UV Paint ♥♥♥♥◇◇



Premium Plus UV Paint ♥♥♥♥◇◇



TECHNICAL INFORMATION

DOOR LEAF CONSTRUCTION

Honeycomb or chipboard core (at extra charge). The construction is skinned with HDF. Size '100' requires third hinge.

FINISH

Glazed models come with 8 mm thick, frosted laminated safety glass panel. Black glazing is available Model A is available with black glazing.

ACCESSORIES

- rebated doors: two or three barrel hinges standard or PRIME.
- Non-rebated doors and reversed rebated doors: two 3D hinges
- lock: key lock, WC lock, or cylinder lock

DOOR FRAMES

Recommended rebated door frames:

- PORTA SYSTEM p. 188
- MINIMAX p. 186

Recommended non-rebated door frames:

- PORTA SYSTEM ELEGANCE p. 190
- PORTA SYSTEM ELEGANCE 90 degrees p. 190
- LEVEL p. 194

Recommended door frames with reversed rebate:

- PORTA SYSTEM with reversed rebate p. 192

NOTES

- Norm PN EN 14351-2:2018-12.
- Double doors are available in any door leaf size combinations.
- Magnetic lock is not available for a double door.
- There are two door leaves (active and passive, sizes 60-100) in double leaf doors.
- Models 4.D, 4.models are not available in double-leaf door option.
- Fixed size of glass, model 4.A
- Ventilation undercut is not available for reversed rebate option apart from model 4.A)
- 4.B models are B, 4.4.B and 4.D models are available only with hollow chipboard core, free of extra charge
- PRIME hinges or 3D hinges – packed with the door frame.

EXTRA CHARGES

- size '100'
- preparation for shortening (max. 60 mm)
- hollow chipboard core
- chipboard core
- ventilation undercut
- black glass panel - model 4.A
- black lock and black barrel hinges
- magnetic lock with stainless steel faceplate
- magnetic lock: black and black barrel hinges (for rebated doors)
- magnetic lock: white, black (for non-rebated doors)
- magnetic lock: gold
- OFFER - prime set without extra charge
- non-rebated door leaves: third 3D hinge, silver, white, black (extra charge to the door frame price)
- non-rebated doors: third 3D hinge, gold (extra charge added to door frame price)
- non-rebated door leaves: 3D hinges, gold (extra charge added to door frame price)
- reversed rebate - extra charge added to door leaf price
- reversed rebate - third 3D hinge, white, black (extra charge added to door frame price)
- reversed rebate - third 3D hinge, silver (extra charge added to door frame price)
- reversed rebate - 3D gold hinges (extra charge added to door frame price)
- reversed rebate - third 3D hinge, gold (extra charge added to door frame price)
- sliding door leaves - oblong pull handle
- sliding door leaves - hook lock with side pull handles
- handle with an escutcheon (p. 213)

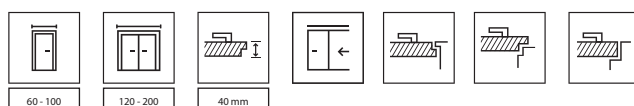



PORTA DUO 4.0, White with Natural Oak panel, ELEGANT handle, silver



DURABLE
Colour



STAIN-RESISTANT
SURFACE



RECOMMENDED
FOR ALLERGY SUFFERERS
AND CHILDREN



SURFACE RESISTANT
TO SCRUBBING



model 4.0



model 4.A



silver handle, Elegant



model 4.0



model 4.A

AVAILABLE FINISHES

Premium Plus UV Paint ♥♥♥♥♥◇



AVAILABLE FINISHES - PANEL

Portadecor Veneer ♥♥♥◇◇◇◇



Natural Veneer ♥♥♥♥♥◇◇



Portaperfect 3D Veneer ♥♥♥♥♥◇◇



Natural Oak Satin Veneer ♥♥♥♥♥◇◇



Natural Veneer - Select ♥♥♥♥♥◇◇



TECHNICAL INFORMATION

DOOR LEAF CONSTRUCTION

Hollow chipboard core. Preparation for shortening in 4.0 model maximum 60 mm. Size '100' requires third hinge.

FINISH

The door leaf consists of: a wide, painted panel and a narrow stile covered with Natural or synthetic Veneer. Glazed model with tempered glass or black laminated safety glass (option at extra charge) with a thickness of 8 mm, which is a structural element of the door leaf thickness. White painted part - satin smooth painted surface achieved by UV Paint technology. Part in Natural Veneer - is protected by ecological water-based varnishes, hardened with UV technology (semi-matt).

ACCESSORIES

- Two 3D hinges
- lock: key lock, WC lock, or cylinder lock

DOOR FRAMES

- PORTA SYSTEM ELEGANCE in Premium plus UV Paint or in the panel colour p. 190
- PORTA SYSTEM ELEGANCE 90 degrees in Premium plus UV Paint or in the panel colour p. 190
- LEVEL finished with Premium Plus UV Paint, see p. 194

NOTES

- Norm PN EN 14351-2:2018-12.
- Double doors are available in any door leaf size combinations.
- Magnetic lock is not available for a double door.
- There are two door leaves (active and passive, sizes 60-100) in double leaf doors.
- Black glazing is available for model 4.A
- Fixed size of glass, model 4.A
- Hinges - packed with a door frame.

EXTRA CHARGES

- size '100'
- ventilation undercut
- black glass panel - model 4.A
- magnetic lock with stainless steel faceplate
- magnetic lock: white, black
- magnetic lock: gold
- third 3D hinge silver, white, black (extra charge to the frame price)
- third 3D hinge - gold (extra charge added to door frame price)
- gold 3D hinges (extra charge added to door frame price)
- handle with an escutcheon

(p. 213)

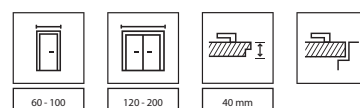



PORTA DESIRE 4, height '220' White, AZALIA handle black



DURABLE FINISH



DIRT-RESISTANT SURFACE



EVERY DETAIL MATTERS



RECOMMENDED FOR ALLERGY SUFFERERS AND CHILDREN



DURABLE AND SMOOTH PAINT



SURFACE RESISTANT TO SCRUBBING



model 1



model 2



model 3



model 4



silver decorative inlay, model 3



black decorative inlay, model 3



gold decorative inlay, model 3

NEW



model 5

NEW



model 6

AVAILABLE FINISHES

Premium Plus UV Paint ♥♥♥♥♥



TECHNICAL INFORMATION

DOOR LEAF CONSTRUCTION

Honeycomb or hollow chipboard core reinforced with glued wood rails and stiles. The construction is skinned with HDF. Height '220' includes three hinges. Size '100' requires third hinge. Preparation for shortening (maximum 60 mm).

FINISH

Models 3, 4, 5 and 6 with decorative door inlays (inlays colours: silver, gold or black).

ACCESSORIES

- rebated doors: three standard barrel hinges, or PRIME hinges
- non-rebated and reversed rebate doors: two 3D hinges
- lock with silver or glossy gold plate: key lock, WC lock, or cylinder lock

DOOR FRAMES

Recommended rebated door frames:

- PORTA System finished with Premium Plus UV Paint, see p. 188
- MINIMAX finished with Premium Plus UV Paint, see p. 186

Recommended non-rebated door frames:

- PORTA SYSTEM ELEGANCE finished with Premium Plus UV Paint, see p. 190
- PORTA SYSTEM ELEGANCE 90 degrees finished with Premium Plus UV Paint, see p. 190
- LEVEL finished with Premium Plus UV Paint, see p. 194

Recommended door frames with reversed rebate:

- PORTA SYSTEM with reversed rebate finished with Premium Plus UV Paint see p. 192

NOTES

- Norm PN EN 14351-2:2018-12.
- Double doors are available in any door leaf size combinations.
- Magnetic lock is not available for a double door.
- There are two door leaves (active and passive, sizes 60-100) in double leaf doors.
- PRIME hinges or 3D hinges – packed with the door frame.

EXTRA CHARGES

- size '100'
- door leaf height 220 cm
- replacing the hollow chipboard core with chipboard core (height '220')
- ventilation undercut
- automatic threshold seal
- black lock and black barrel hinges
- magnetic lock with stainless steel faceplate
- magnetic lock: black and black barrel hinges (for rebated doors)
- magnetic lock: white, black (for non-rebated doors)
- magnetic lock: gold
- non-rebated door leaves: third 3D hinge, silver, white, black (extra charge to the door frame price)
- non-rebated doors: third 3D hinge, gold (extra charge added to door frame price)
- non-rebated door leaves: 3D hinges, gold (extra charge added to door frame price)
- reversed rebate - extra charge added to door leaf price
- reversed rebate - third 3D hinge, white, black (extra charge added to door frame price)
- reversed rebate - third 3D hinge, silver (extra charge added to door frame price)
- reversed rebate - 3D gold hinges (extra charge added to door frame price)
- reversed rebate - third 3D hinge, gold (extra charge added to door frame price)
- sliding door leaves - oblong pull handle
- sliding door leaves - hook lock with side pull handles
- handle with an escutcheon

(p. 213)

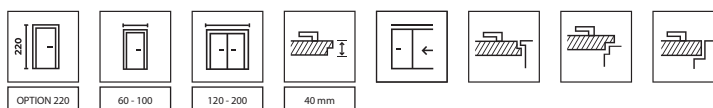



PORTA GRANDE A.0, Grey with PORTA SYSTEM ELEGANCE door frame, AZURA handle, silver



DURABLE FINISH



STAIN-RESISTANT SURFACE



RECOMMENDED FOR ALLERGY SUFFERERS AND CHILDREN



DURABLE AND SMOOTH PAINT



model A.0



model A.1



model B.0



model B.3



AZURA door handle



decorative slat



model C.0



model D.0



model G.0



Model G.4, frosted or black glazing (option at extra charge)



mirror - option available in model A.1

AVAILABLE FINISHES

Premium Plus UV Paint ◆◆◆◆◆◇



AVAILABLE FINISHES OF DECORATIVE SLATS (option in models of group G)

Natural Veneer ◆◆◆◆◆◇



Brushed aluminum



Portaperfect 3D Veneer ◆◆◆◆◆◇



TECHNICAL INFORMATION

DOOR LEAF CONSTRUCTION

Frame and panel construction. Door leaves contain stiles and frosted, tempered glass. Preparation for shortening maximum 60 mm. Size '100' requires third hinge.

FINISH

It is possible to produce model A.1 with mirror on one or on both sides. If a mirror is only on one side, there is a solidboard on the other side. For white door leaves there is a choice of decorative slat in synthetic Veneer, Natural Veneer and brushed aluminium. They are recessed in comparison to the surface of a door leaf panel (model G).

ACCESSORIES

- rebated doors: three standard barrel hinges, or PRIME hinges
- non-rebated and reversed rebate doors: two 3D hinges
- lock with silver or glossy gold plate: key lock, WC lock, or cylinder lock
- oblong pull handle for sliding doors

DOOR FRAMES

Recommended rebated door frames:

- PORTA System finished with Premium Plus UV Paint, see p. 188
- MINIMAX finished with Premium Plus UV Paint, see p. 186

Recommended non-rebated door frames:

- PORTA SYSTEM ELEGANCE finished with Premium Plus UV Paint, see p. 190
- PORTA SYSTEM ELEGANCE 90 degrees finished with Premium Plus UV Paint, see p. 190
- LEVEL finished with Premium Plus UV Paint, see p. 194

Recommended door frames with reversed rebate:

- PORTA SYSTEM with reversed rebate finished with Premium Plus UV Paint see p. 192

NOTES

- Norm PN EN 14351-2:2018-12.
- Double doors are available in any door leaf size combinations.
- Magnetic lock is not available for a double door.
- There are two door leaves (active and passive, sizes 60-100) in double leaf doors.
- PRIME hinges or 3D hinges – packed with the door frame.

EXTRA CHARGES

- size '100'
- ventilation undercut
- black glazing 1 pc. - gr G
- decorative slat: brushed aluminum - model G (white door leaf)
- decorative slat: Natural Veneer - model G (white door leaf)
- decorative slat: Portaperfect - model G (White door leaf)
- mirror on both sides
- mirror on one side
- black lock and black barrel hinges
- magnetic lock with stainless steel faceplate
- magnetic lock: black and black barrel hinges (for rebated doors)
- magnetic lock: white, black (for non-rebated doors)
- magnetic lock: gold
- non-rebated door leaves: third 3D hinge, silver, white, black (extra charge to the door frame price)
- non-rebated doors: third 3D hinge, gold (extra charge added to door frame price)
- non-rebated door leaves: 3D hinges, gold (extra charge added to door frame price)
- reversed rebate - extra charge added to door leaf price
- reversed rebate - third 3D hinge, white, black (extra charge added to door frame price)
- reversed rebate - third 3D hinge, silver (extra charge added to door frame price)
- reversed rebate - 3D gold hinges (extra charge added to door frame price)
- reversed rebate - third 3D hinge, gold (extra charge added to door frame price)
- sliding door leaves - oblong pull handle
- sliding door leaves - hook lock with side pull handles
- handle with an escutcheon

(p. 213)

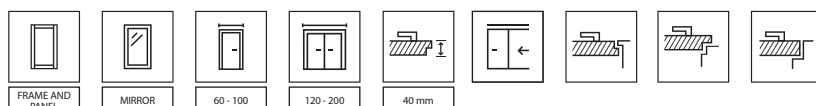



PORTA FACTOR 3, White, handle ORGANIC black structure



DURABLE FINISH



RECOMMENDED FOR ALLERGY SUFFERERS AND CHILDREN



model 0



model 1



model 2

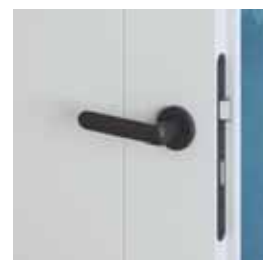

ORGANIC handle



decorative milling close up



model 3



model 4



model 5



model 6

AVAILABLE FINISHES

Standard UV Paint ♥♥♥♥◇◇◇◇



TECHNICAL INFORMATION

DOOR LEAF CONSTRUCTION

Honeycomb or hollow chipboard core reinforced with rails and stiles (at extra charge). The construction is skinned with HDF. Chipboard core have preparation for shortening as a standard. Size '110' is available only with chipboard core. Size '100' and '110' and reinforcement for a door closer require third hinge.

ACCESSORIES

- rebated doors: - Two or three standard barrel hinges or PRIME hinges (optionally, at extra charge)
- non-rebated doors: two 3D hinges
- lock: key lock, WC lock, or cylinder lock
- oblong pull handle for sliding doors

DOOR FRAMES

Recommended rebated door frames:

- PORTA SYSTEM finished with Premium lacquered Veneer p. 188
- MINIMAX finished with Premium lacquered Veneer p. 186
- STEEL door frames see p. 198-203

Recommended non-rebated door frames:

- PORTA SYSTEM ELEGANCE finished with Premium lacquered Veneer p. 190
- PORTA SYSTEM ELEGANCE 90 degrees finished with Premium lacquered Veneer p. 190

NOTES

- Norm PN EN 14351-2:2018-12
- Double doors are available in any door leaf size combinations.
- Magnetic lock is not available for a double door.
- There are two door leaves (active and passive, sizes 60-100) in double leaf doors.
- PRIME hinges or 3D hinges – packed with the door frame.

EXTRA CHARGES

- size '100', '110'
- preparation for shortening (max. 60 mm)
- hollow chipboard core
- chipboard core
- ventillation undercut, sleeves or ventilation grille
- automatic threshold seal
- PRIME hinges (for dedicated door frames)
- PRIME lock with glossy faceplate (silver or gold)
- black lock and black barrel hinges
- magnetic lock with stainless steel faceplate
- magnetic lock: black and black barrel hinges (for rebated doors)
- magnetic lock: white, black (for non-rebated doors)
- magnetic lock: gold
- non-rebated door leaves: third 3D hinge, silver, white, black (extra charge to the door frame price)
- non-rebated doors: third 3D hinge, gold (extra charge added to door frame price)
- non-rebated door leaves: 3D hinges, gold (extra charge added to door frame price)
- sliding door leaves - oblong pull handle
- sliding door leaves - hook lock with side pull handles
- reinforcement for a door closer requires third hinge
- handle with an escutcheon

(p. 213)

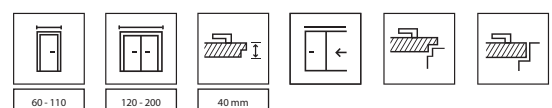



PORTA ROYAL A, White, OFFICE silver handle



RECOMMENDED FOR ALLERGY SUFFERERS AND CHILDREN



PORTA ROYAL model A



LONDON model P



LONDON model O



LONDON model B



LONDON model C



PORTA ROYAL model P



VIENNA model P



VIENNA model O



VIENNA model B



VIENNA model C

PORTA ROYAL PREMIUM, LONDON, VIENNA

BUDGET ●○○

AVAILABLE FINISHES FOR PORTA ROYAL, LONDON

Premium Paint ♥♥♥♥♥



Finish available for collections:
LONDON and ROYAL - smooth surface.



LONDON, VIENNA wood grains



LONDON, ROYAL smooth surface

AVAILABLE FINISHES - LONDON, VIENNA

Standard Paint ♥♥♥♥♥



Finish available for collections:
LONDON and VIENNA - surface with visible wood grains.

TECHNICAL INFORMATION

DOOR LEAF CONSTRUCTION

Stabilising infill or hollow chipboard core (PORTA ROYAL - optionally at an extra charge) skinned with embossed HDF. Reinforcement for a door closer requires third hinge.

ACCESSORIES

- rebated doors (PORTA ROYAL, LONDON, VIENNA): - Two or three standard barrel hinges or PRIME hinges
- non-rebated (PORTA ROYAL): two 3D hinges
- lock: key lock, WC lock, or cylinder lock
- Chinchilla 'glass' (LONDON, VIENNA)
- oblong pull handle for sliding doors

DOOR FRAMES

Recommended rebated door frames:

- PORTA SYSTEM in Portadecor or Premium lacquered Veneer (PORTA ROYAL, LONDON) see p. 188
- MINIMAX in Portadecor or Premium (PORTA ROYAL, LONDON) lacquered Veneer see p. 186
- STEEL door frames p. 198-203

Recommended non-rebated door frames (PORTA ROYAL):

- PORTA SYSTEM ELEGANCE finished with Premium lacquered Veneer see p. 190
- PORTA SYSTEM ELEGANCE 90 degrees finished with Premium lacquered Veneer see p. 190
- LEVEL finished with Premium lacquered Veneer see p. 194

NOTES

- Norm PN EN 14351-2:2018-12.
- Double doors are available in any door leaf size combinations.
- Magnetic lock is not available for a double door.
- There are two door leaves (active and passive, sizes 60-100) in double leaf doors.
- LONDON, VIENNA: due to various materials use, there might be a slight colour difference between door leaf and a glazing bead/muntin.
- PRIME hinges or 3D hinges - packed with the door frame.

EXTRA CHARGES- PORTA ROYAL

- preparation for shortening (max. 60 mm)
- chipboard core
- ventilation sleeves or ventilation undercut
- automatic threshold seal
- black lock and black barrel hinges
- magnetic lock with stainless steel faceplate
- magnetic lock: black and black barrel hinges (for rebated doors)
- magnetic lock: white, black (for non-rebated doors)
- magnetic lock: gold
- OFFER - prime set without extra charge
- non-rebated door leaves: third 3D hinge, silver, white, black (extra charge to the door frame price)
- non-rebated doors: third 3D hinge, gold (extra charge added to door frame price)
- non-rebated door leaves: 3D hinges, gold (extra charge added to door frame price)
- sliding door leaves - oblong pull handle
- sliding door leaves - hook lock with side pull handles
- reinforcement for a door closer requires third hinge handle with an escutcheon (p. 213)

EXTRA CHARGES, LONDON, VIENNA

- preparation for shortening (max. 60 mm)
- ventilation sleeves or ventilation undercut
- PRIME hinges (for dedicated door frames)
- PRIME lock with glossy faceplate (silver or gold)
- black lock and black barrel hinges
- magnetic lock with stainless steel faceplate
- magnetic lock: black and black barrel hinges (for rebated doors)
- magnetic lock: gold
- sliding door leaves - oblong pull handle
- sliding door leaves - hook lock with side pull handles
- reinforcement for a door closer requires third hinge handle with an escutcheon (p. 213)

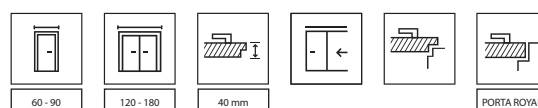



MINIMAX P, White with PORTA SYSTEM steel door frame, EUFORIA handle black



RECOMMENDED
FOR ALLERGY SUFFERERS
AND CHILDREN



model M



model D



model L



model P



model 1



model 2



model 3



model 4



model 5



model 6

AVAILABLE FINISHES

Standard Paint ♥♥♥♥♥



ACCENT PLUS handle



'Chinchilla' glass panel

TECHNICAL INFORMATION

DOOR LEAF CONSTRUCTION

Honeycomb or chipboard core reinforced with rails and stiles (at extra charge). The construction is skinned with HDF. Chipboard core have preparation for shortening as a standard. - Size '110' is available only with chipboard core. Glazing size is the same as for size '100' Size '100' and '110' and reinforcement for a door closer require third hinge.

FINISH

Door leaves available in 'paint yourself' option are in the same price as MINIMAX white. 'Chinchilla' glass or frosted tempered glass (optionally, extra charge). Due to various materials use, there might be a slight colour difference between door leaf and a glazing bead.

ACCESSORIES

- two or three standard barrel hinges or PRIME hinges (optionally, at extra charge)
- lock: key lock, WC lock, or cylinder lock
- oblong pull handle for sliding doors

DOOR FRAMES

- PORTA SYSTEM in Portadecor Veneer see p. 188
- MINIMAX in Portadecor Veneer see p. 186
- STEEL door frames see p. 198-203

NOTES

- Norm PN EN 14351-2:2018-12
- Double doors are available in any door leaf size combinations.
- Magnetic lock is not available for a double door.
- Passive leaf sizes: from '60' to '100' Passive door leaves (side panels) in sizes '30', '40', '50' available only in solid option (without decorative applications).
- There are two door leaves (active and passive, sizes 60-100) in double leaf doors.
- Size '80' and '90' in investment norm (clear opening width 800, 900 mm) available as a standard- without extra charge.
- PRIME - Hinges - packed with a door frame.

EXTRA CHARGES

- size '100', '110'
- preparation for shortening (max. 60 mm)
- hollow chipboard core
- chipboard core
- ventillation undercut, sleeves or ventilation grille
- automatic threshold seal
- stainless steel porthole
- black porthole
- OFFER - prime set without extra charge
- frosted tempered glass - model D
- frosted tempered glass - model L
- frosted tempered glass - model M
- PRIME hinges (for dedicated door frames)
- PRIME lock with glossy faceplate (silver or gold)
- black lock and black barrel hinges
- magnetic lock with stainless steel faceplate
- magnetic lock: black and black barrel hinges (for rebated doors)
- magnetic lock: gold
- sliding door leaves - oblong pull handle
- sliding door leaves - hook lock with side pull handles
- reinforcement for a door closer requires third hinge
- handle with an escutcheon (p. 213)

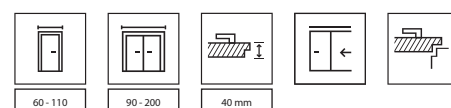



PORTA GLASS, matt graphite glass



SAFE TEMPERED GLASS



MORE LIGHT



matt
graphite glass



frosted glass



transparent
glass



matt



silver lock



frosted glass with painted
muntins



transparent glass with
painted muntins

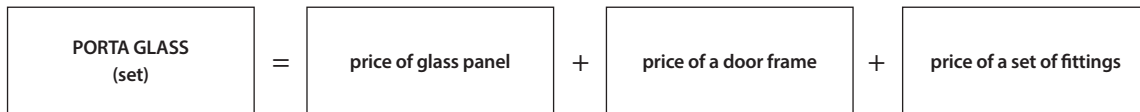

TECHNICAL INFORMATION

DOOR LEAF

Tempered glass panel of 8 mm thickness with prepared holes for mounting the lock and hinges.

ACCESSORIES

- Standard lock (handle only), bathroom lock or adapted for cylinder lock in silver or black.
- Two hinges in silver or black.

DOOR FRAMES

- PORTA SYSTEM p. 188
- STEEL door frames see p. 198-203

NOTES

- Norm PN-EN 14351-2:2018-12
- Lock and hinges packed separately.
- Line width in patterns with painted muntins - 30 mm. The muntin is painted on one side on the hinge side (i.e. the door opens to you).
- The frosted glass is on one side on the hinge side (i.e. the door opens to you).

EXTRA CHARGES

size '90'

- ventilation undercut

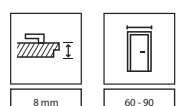



NATURE LUMIA 1, Black, ESTIMA pull, black



SAFE TEMPERED GLASS



MORE LIGHT



INNOVATIVE LOCK FOR PULL HANDLE



WOODEN CONSTRUCTION



model 1



model 1



ESTIMA door pull



magnetic lock



model 2



model 2



3D hinge

PORTA LUMIA, NATURE LUMIA

PREMIUM ●●●

PORTA LUMIA - AVAILABLE FINISHES

Premium Lacquered Veneer ♥♥♥♥◇◇



White

SUPER MATT Veneer ♥♥♥♥◇◇



Black

NATURE LUMIA - AVAILABLE FINISHES

Natural Oak Satin Veneer ♥♥♥♥◇◇



White

Natural Select Veneer ♥♥♥♥◇◇



Black

TECHNICAL INFORMATION

DOOR LEAF CONSTRUCTION

Rails and stiles are made of glued, laminated pine. No possibility of shortening the door leaf. The product is available with 6 mm thick clear tempered glass.

ACCESSORIES

- two, non-rebated 3D hinges
- magnetic lock
- hardware colors: white, black, matt silver

DOOR FRAMES

- PORTA SYSTEM ELEGANCE p. 190
- PORTA SYSTEM ELEGANCE 90 degrees p. 190

NOTES

- Norm PN EN 14351-2:2018-12
- Hinges - packed with a door frame.
- Minimum drilling distance for the handle: 18 mm from the glass.
- PORTA LUMIA - The lower surface of stiles are protected against humidity thanks to TechnoPORTA AQUA STOP.

EXTRA CHARGES

strike plate dedicated to a door frame (extra charge to the frame price)
non-rebated door leaves: third 3D hinge, silver, white, black (extra charge to the door frame price)
door pull (white or black)



FRAME AND PANEL

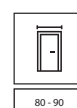

80 - 90

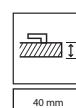

40 mm

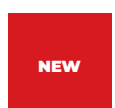



PORTA VERTE HOME N.3, transparent glass, LUNA handle black



GLAZING
MORE LIGHT



AQUA STOP



model B.5



model B.5 painted
glass panel
transparent



SIMPLE handle



frosted glass or transparent glass
(for an extra charge)



model L.4



model N.3

AVAILABLE FINISHES

SUPER MATT Veneer ♥♥♥◇◇◇



TECHNICAL INFORMATION

DOOR LEAF CONSTRUCTION

Depending on the design, the door leaf consist of horizontal stiles and glass panels made of tempered glass. Glass with a thickness of 4 mm. Preparation for shortening (maximum 30 mm) Size '100' requires third hinge.

ACCESSORIES

- lock: key lock, WC lock, cylinder lock, handle only
- rebated doors: three standard barrel hinges or PRIME hinges (at extra charge)
- non-rebated doors: two 3D hinges
- frosted or transparent tempered glass (at extra charge)
- oblong pull handle for sliding doors

DOOR FRAMES

Recommended rebated door frames:

- PORTA SYSTEM p. 188

Recommended non-rebated door frames:

- PORTA SYSTEM ELEGANCE p. 190

- PORTA SYSTEM ELEGANCE 90 degrees p. 190

NOTES

- Norm PN EN 14351-2:2018-12.
- Double doors are available in any door leaf size combinations.
- Magnetic lock is not available for a double door.
- There are two door leaves (active and passive, sizes 60-100) in double leaf doors.
- The width (thickness) of the painted lines on model B.5 is 25 mm, one-side pattern.
- PRIME hinges or 3D hinges – packed with the door frame.
- The lower surface of stiles are protected against humidity thanks to TechnoPORTA AQUA STOP.
- Door leaf, model B.5 with transparent painted glass is not available for sliding option.

EXTRA CHARGES

size '100'

- ventilation sleeves or ventilation undercut
- transparent painted glass panel model B.5
- transparent glass panel model L.4 1 pc.
- transparent glass panel model N.3 1 pc.
- PRIME hinges (for dedicated door frames)
- PRIME lock with glossy faceplate (silver or gold)
- black lock and black barrel hinges
- magnetic lock with stainless steel faceplate
- magnetic lock: black and black barrel hinges (for rebated doors)
- magnetic lock: white, black (for non-rebated doors)
- magnetic lock: gold
- non-rebated door leaves: third 3D hinge, silver, white, black (extra charge to the door frame price)
- non-rebated doors: third 3D hinge, gold (extra charge added to door frame price)
- non-rebated door leaves: 3D hinges, gold (extra charge added to door frame price)
- sliding door leaves - oblong pull handle
- sliding door leaves - hook lock with side pull handles
- handle with an escutcheon

(p. 213)

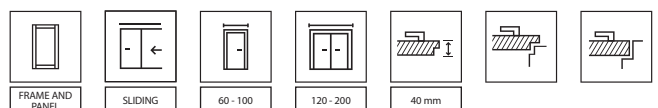



STEEL PORTA LOFT, model 1



SAFETY LAMINATED
GLASS



STEEL
CONSTRUCTION



GLAZING
MORE LIGHT



model 1



model 2



model 3



door pull



hinge

AVAILABLE FINISHES

Powder coating ♥♥♥♥◇◇



K Do you have your own door or colour concept?
Customize the product to meet your individual needs.
Check the possibilities at PORTA CONTACT.

TECHNICAL INFORMATION

DOOR LEAF CONSTRUCTION

Steel frame and leaf in structured black colour (powder coating) . Rails and stiles with a cross-section of 40 mm by 20 mm, internal muntins of width 15 mm. Transparent, safety laminated glass, 6 mm thick.

FULL SET

- steel door leaf
- dedicated steel frame
- a set of hardware: hinges, door pull, magnet

DOOR FRAME

A door frame dedicated to this product

NOTES

- Norm PN EN 14351-2:2018-12.
- Dimensions see page. 229, Table 10.

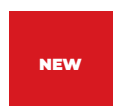
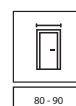



PORTA CONCEPT A.9, Natural Oak, handle ELEGANT silver



MATCH THE DOOR TO FLOORS AND FURNITURE



WOODEN CONSTRUCTION



IN YOUR FAVORITE COLOURS



AQUA STOP



model A.0



model A.2



model A.3



ELEGANT door handle



model A.4



model A.6



model A.7



flat panel



model A.8



model A.9



model A.9 with black glazing



adjustment of 3D adjustable barrel hinges

AVAILABLE FINISHES

Premium Lacquered Veneer ◆◆◆◆◆



White

Portadecor Veneer ◆◆◆◆◆



White

Grey

Whitened Walnut

Catania Oak

Verona Walnut 2

Portasynchro 3D Veneer ◆◆◆◆◆



Wenge White

Norwegian Pine

Andersen Pine

Silver Acacia

Honey Acacia

Scarlet Oak

Dark Oak

Portaperfect 3D Veneer ◆◆◆◆◆

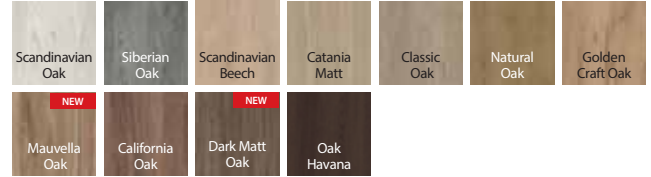

Scandinavian Oak

Siberian Oak

Scandinavian Beech

Catania Matt

Classic Oak

Natural Oak

Golden Craft Oak

Mauvella Oak

California Oak

Dark Matt Oak

Oak Havana

Portalamino ◆◆◆◆◆

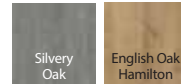

Silvery Oak

English Oak Hamilton

WE RECOMMEND!

Special, multilayer wooden construction (option at extra charge).



TECHNICAL INFORMATION

DOOR LEAF CONSTRUCTION

Door leaves contain rails and stiles, slim panels and 6 mm thick, frosted, tempered glass. Combination of those depends on a model. Preparation for shortening maximum 60 mm. Size '100' requires third hinge.

ACCESSORIES

- lock: key lock, WC lock, cylinder lock
- rebated doors: three adjustable barrel hinges 3D
- non-rebated doors: two 3D hinges
- oblong pull handle for sliding doors

DOOR FRAMES

Recommended rebated door frames:

- PORTA SYSTEM p. 188

Recommended non-rebated door frames:

- PORTA SYSTEM ELEGANCE p. 190

- PORTA SYSTEM ELEGANCE 90 degrees p. 190

- LEVEL p. 194

NOTES

- Norm PN EN 14351-2:2018-12.
- Double doors are available in any door leaf size combinations.
- Magnetic lock is not available for a double door.
- There are two door leaves (active and passive, sizes 60-100) in double leaf doors.
- Hinges - packed with a door frame.
- The lower surface of stiles are protected against humidity thanks to TechnoPORTA AQUA STOP.

EXTRA CHARGES

size '100'

multilayer wooden construction (stiles)

ventilation sleeves or ventilation undercut

magnetic lock with stainless steel faceplate

magnetic lock: white, black (for non-rebated doors)

magnetic lock: gold

non-rebated door leaves: third 3D hinge, silver, white, black (extra charge to the door frame price)

non-rebated doors: third 3D hinge, gold (extra charge added to door frame price)

non-rebated door leaves: 3D hinges, gold (extra charge added to door frame price)

sliding door leaves - oblong pull handle

sliding door leaves - hook lock with side pull handles

handle with an escutcheon

(p. 212)



FRAME AND PANEL

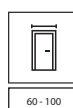

60 - 100



120 - 200

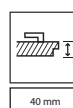

40 mm

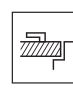
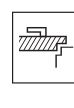
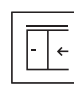



PORTA CONCEPT C.6, White, handle ELEGANT silver



MATCH THE DOOR TO FLOORS AND FURNITURE



WOODEN CONSTRUCTION



IN YOUR FAVORITE COLOURS



AQUA STOP



model C.0



model C.1



model C.2



model C.3



ELEGANT door handle



model C.4



model C.5



model C.6



flat panel



adjustment of 3D adjustable barrel hinges

AVAILABLE FINISHES

Premium Lacquered Veneer ◆◆◆◆◆◆



Portadecor Veneer ◆◆◆◆◆◆



Portasynchro 3D Veneer ◆◆◆◆◆◆



Portaperfect 3D Veneer ◆◆◆◆◆◆

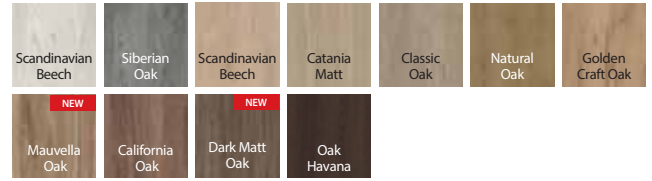

Portalamino ◆◆◆◆◆◆

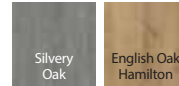

WE RECOMMEND!

Special multi-layer wooden construction (option at extra charge).



TECHNICAL INFORMATION

DOOR LEAF CONSTRUCTION

Door leaves contain rails and stiles, slim panels and 6 mm thick, frosted, tempered glass. Combination of those depends on a model. Preparation for shortening maximum 60 mm. Size '100' requires third hinge.

ACCESSORIES

- lock: key lock, WC lock, cylinder lock
- rebated doors: three adjustable barrel hinges 3D
- non-rebated doors: two 3D hinges
- oblong pull handle for sliding doors

DOOR FRAMES

Recommended rebated door frames:

- PORTA SYSTEM p. 188

Recommended non-rebated door frames:

- PORTA SYSTEM ELEGANCE p. 190
- PORTA SYSTEM ELEGANCE 90 degrees p. 190
- LEVEL p. 194

NOTES

- Norm PN EN 14351-2:2018-12.
- Double doors are available in any door leaf size combinations.
- Magnetic lock is not available for a double door.
- There are two door leaves (active and passive, sizes 60-100) in double leaf doors.
- Hinges - packed with a door frame.
- The lower surface of stiles are protected against humidity thanks to TechnoPORTA AQUA STOP.

EXTRA CHARGES

- size '100'
- multilayer wooden construction (stiles)
- ventilation sleeves or ventilation undercut
- magnetic lock with stainless steel faceplate
- magnetic lock: white, black (for non-rebated doors)
- magnetic lock: gold
- non-rebated door leaves: third 3D hinge, silver, white, black (extra charge to the door frame price)
- non-rebated doors: third 3D hinge, gold (extra charge added to door frame price)
- non-rebated door leaves: 3D hinges, gold (extra charge added to door frame price)
- sliding door leaves - oblong pull handle
- sliding door leaves - hook lock with side pull handles
- handle with an escutcheon

(p. 212)

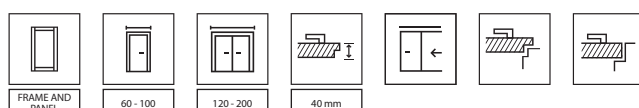



PORTA CONCEPT K.3, English Oak Hamilton, handle ELEGANT silver



MATCH THE DOOR TO FLOORS AND FURNITURE



WOODEN CONSTRUCTION



IN YOUR FAVORITE COLOURS



AQUA STOP



model H.0



model H.1



model H.2



model H.4



ELEGANT door handle



model K.0



model K.1



model K.2



model K.3



flat panel



adjustment of 3D adjustable barrel hinges

PORTA CONCEPT, group H and K

PREMIUM ●●●

AVAILABLE FINISHES

Premium Lacquered Veneer ◆◆◆◆◆



Portadecor Veneer ◆◆◆◆◆



Portasynchro 3D Veneer ◆◆◆◆◆



Portaperfect 3D Veneer ◆◆◆◆◆

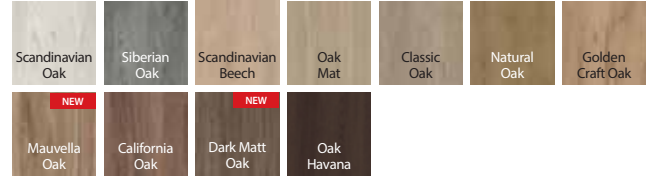

Portalamino ◆◆◆◆◆

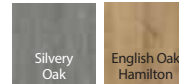

WE RECOMMEND!

Special multi-layer wooden construction (option at extra charge).



TECHNICAL INFORMATION

DOOR LEAF CONSTRUCTION

Door leaves contain rails and stiles, slim panels and 6 mm thick, frosted, tempered glass. Combination of those depends on a model. Preparation for shortening maximum 60 mm. Size '100' requires third hinge.

ACCESSORIES

- lock: key lock, WC lock, cylinder lock
- rebated doors: three adjustable barrel hinges 3D
- non-rebated doors: two 3D hinges
- oblong pull handle for sliding doors

DOOR FRAMES

Recommended rebated door frames:

- PORTA SYSTEM p. 188

Recommended non-rebated door frames:

- PORTA SYSTEM ELEGANCE p. 190
- PORTA SYSTEM ELEGANCE 90 degrees p. 190
- LEVEL p. 194

NOTES

- Norm PN EN 14351-2:2018-12.
- Double doors are available in any door leaf size combinations.
- Magnetic lock is not available for a double door.
- There are two door leaves (active and passive, sizes 60-100) in double leaf doors.
- Hinges - packed with a door frame.
- The lower surface of stiles are protected against humidity thanks to TechnoPORTA AQUA STOP.

EXTRA CHARGES

- size '100'
- multilayer wooden construction (stiles)
- ventilation sleeves or ventilation undercut
- magnetic lock with stainless steel faceplate
- magnetic lock: white, black (for non-rebated doors)
- magnetic lock: gold
- non-rebated door leaves: third 3D hinge, silver, white, black (extra charge to the door frame price)
- non-rebated doors: third 3D hinge, gold (extra charge added to door frame price)
- non-rebated door leaves: 3D hinges, gold (extra charge added to door frame price)
- sliding door leaves - oblong pull handle
- sliding door leaves - hook lock with side pull handles
- handle with an escutcheon

(p. 212)

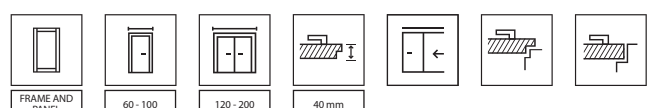



PORTA HARMONY B.0, Olive, LUNGO door handle Black



MATCH THE DOOR TO FLOORS AND FURNITURE



IN YOUR FAVORITE COLOURS



AQUA STOP



PORTA BALANCE model A.0



PORTA BALANCE model B.0



PORTA BALANCE model B.1



LUNGO handle



PORTA BALANCE model D.1



PORTA BALANCE model D.2



PORTA BALANCE model D.3



PORTA HARMONY model A.0



PORTA HARMONY model A.1



fancy profiled panel



PORTA HARMONY model B.0



PORTA HARMONY model B.1



PORTA HARMONY model B.2



PORTA HARMONY model C.0



PORTA HARMONY model C.1

PORTA BALANCE, PORTA HARMONY

PREMIUM ●●●

AVAILABLE FINISHES

Portadecor Veneer ♥♥♥♥♥



Portasynchro 3D Veneer ♥♥♥♥♥



Portaperfect 3D Veneer ♥♥♥♥♥

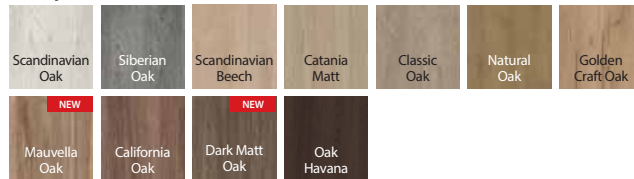

Portalamino ♥♥♥♥♥

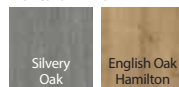

TECHNICAL INFORMATION

DOOR LEAF CONSTRUCTION

Door leaves contain rails and stiles, slim panels and 4 mm thick, frosted, tempered glass. Combination of those depends on a model. Preparation for shortening (maximum 30 mm) Size '100' requires third hinge.

ACCESSORIES

- lock: key lock, WC lock, cylinder lock
- rebated doors: three standard barrel hinges or PRIME hinges (at extra charge)
- non-rebated doors: two 3D hinges
- oblong pull handle for sliding doors

DOOR FRAMES

Recommended rebated door frames:

- PORTA SYSTEM p. 188
- MINIMAX p. 186
- STEEL door frames p. 198-203

Recommended non-rebated door frames:

- PORTA SYSTEM ELEGANCE p. 190
- PORTA SYSTEM ELEGANCE 90 degrees p. 190
- LEVEL p. 194

NOTES

- Norm PN EN 14351-2:2018-12.
- Double doors are available in any door leaf size combinations.
- Magnetic lock is not available for a double door.
- There are two door leaves (active and passive, sizes 60-100) in double leaf doors.
- PRIME hinges or 3D hinges – packed with the door frame.
- The lower surface of stiles are protected against humidity thanks to TechnoPORTA AQUA STOP.

EXTRA CHARGES

- size '100'
- ventilation sleeves or ventilation undercut
- PRIME hinges (for dedicated door frames)
- PRIME lock with glossy faceplate (silver or gold)
- black lock and black barrel hinges
- magnetic lock with stainless steel faceplate
- magnetic lock: black and black barrel hinges (for rebated doors)
- magnetic lock: white, black (for non-rebated doors)
- magnetic lock: gold
- non-rebated door leaves: third 3D hinge, silver, white, black (extra charge to the door frame price)
- non-rebated doors: third 3D hinge, gold (extra charge added to door frame price)
- non-rebated door leaves: 3D hinges, gold (extra charge added to door frame price)
- sliding door leaves - oblong pull handle
- sliding door leaves - hook lock with side pull handles
- handle with an escutcheon

(p. 212)

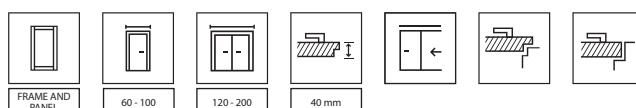



PORTA INSPIRE A.0, Scandinavian Oak, retro module, ELEGANT handle black



MATCH THE DOOR TO FLOORS AND FURNITURE



WOODEN CONSTRUCTION



IN YOUR FAVORITE COLOURS



AQUA STOP



model A.0



model A.1



model A.1 with mirror



SIMPLE handle



model B.0



model B.1



model B.2



model B.3



model C.4 with black glazing



frosted glass panel, 'frame'
- Group A and B models



model C.0



model C.1



model C.2



model C.3



model C.4



adjustment of 3D adjustable barrel hinges

AVAILABLE FINISHES

Premium Lacquered Veneer ◆◆◆◆◆◆



* finish available only for Group C models

Portadecor Veneer ◆◆◆◆◆◆



Portasynchro 3D Veneer ◆◆◆◆◆◆



Portaperfect 3D Veneer ◆◆◆◆◆◆

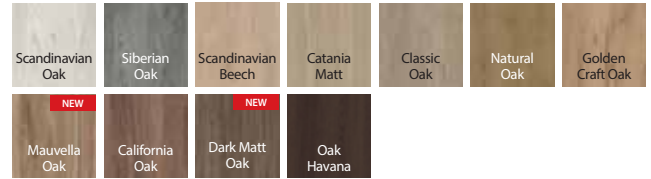

Portalamino ◆◆◆◆◆◆



WE RECOMMEND!

Special multi-layer wooden construction (option at extra charge).



TECHNICAL INFORMATION

DOOR LEAF CONSTRUCTION

Door leaves contain rails and stiles, slim panels and 6 mm thick, frosted, tempered glass. Combination of those depends on a model. Preparation for shortening maximum 60 mm. Size '100' requires third hinge.

FINISH

It is possible to produce model A.1 with mirror on one or on both sides. If a mirror is only on one side, there is a solidboard on the other side. Frosted tempered glass panel 'frame' and frosted glass.

ACCESSORIES

- lock: key lock, WC lock, cylinder lock
- rebated doors: three adjustable barrel hinges 3D
- non-rebated doors: two 3D hinges
- oblong pull handle for sliding doors

DOOR FRAMES

Recommended rebated door frames:

- PORTA SYSTEM p. 188

Recommended non-rebated door frames:

- PORTA SYSTEM ELEGANCE p. 190

- PORTA SYSTEM ELEGANCE 90 degrees p. 190

- LEVEL p. 194

NOTES

- Norm PN EN 14351-2:2018-12.
- Double doors are available in any door leaf size combinations.
- Magnetic lock is not available for a double door.
- There are two door leaves (active and passive, sizes 60-100) in double leaf doors.
- Hinges - packed with a door frame.
- The lower surface of stiles are protected against humidity thanks to TechnoPORTA AQUA STOP.

EXTRA CHARGES

- size '100'
- multilayer wooden construction (stiles)
- ventilation sleeves or ventilation undercut
- black glazing 1 pc. - gr C
- mirror on both sides
- mirror on one side
- magnetic lock with stainless steel faceplate
- magnetic lock: white, black (for non-rebated doors)
- magnetic lock: gold
- non-rebated door leaves: third 3D hinge, silver, white, black (extra charge to the door frame price)
- non-rebated doors: third 3D hinge, gold (extra charge added to door frame price)
- non-rebated door leaves: 3D hinges, gold (extra charge added to door frame price)
- sliding door leaves - oblong pull handle
- sliding door leaves - hook lock with side pull handles
- handle with an escutcheon

(p. 212)

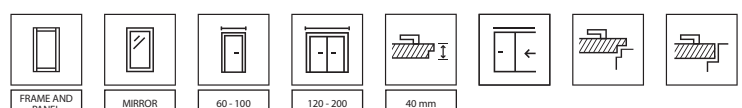



PORTA VERTE PREMIUM A.4, Scarlet Oak, ELEGANT silver handle



MATCH THE DOOR TO FLOORS AND FURNITURE



IN YOUR FAVORITE COLOURS



AQUA STOP



model A.0



model A.1



model A.2



model A.3



model A.4



ELEGANT door handle



model D.0



model D.1



model D.2



model D.3



model A.0 - flat panel



model D.5



model D.6



model D.7



model D.8



model D.8 - frosted glass panel

PORTA VERTE PREMIUM, group A and D

OPTIMUM ●●●

AVAILABLE FINISHES

Premium Lacquered Veneer ◆◆◆◆◆◆



Portasynchro 3D Veneer ◆◆◆◆◆◆



Portaperfect 3D Veneer ◆◆◆◆◆◆

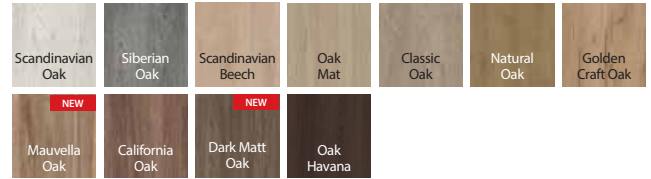

Portalamino ◆◆◆◆◆◆

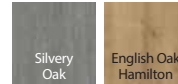

TECHNICAL INFORMATION

DOOR LEAF CONSTRUCTION

Door leaves contain rails and stiles, slim panels and 6 mm thick, frosted, tempered glass. Combination of those depends on a model. Preparation for shortening maximum 60 mm. Size '100' requires third hinge.

ACCESSORIES

- lock: key lock, WC lock, cylinder lock
- rebated doors: three standard barrel hinges, or PRIME hinges
- non-rebated doors: two 3D hinges
- oblong pull handle for sliding doors

DOOR FRAMES

Recommended rebated door frames:

- PORTA SYSTEM p. 188
- MINIMAX p. 186
- STEEL door frames p. 198-203

Recommended non-rebated door frames:

- PORTA SYSTEM ELEGANCE p. 190
- PORTA SYSTEM ELEGANCE 90 degrees p. 190
- LEVEL p. 194

NOTES

- Norm PN EN 14351-2:2018-12.
- Double doors are available in any door leaf size combinations.
- Magnetic lock is not available for a double door.
- There are two door leaves (active and passive, sizes 60-100) in double leaf doors.
- PRIME hinges or 3D hinges – packed with the door frame.
- The lower surface of stiles are protected against humidity thanks to TechnoPORTA AQUA STOP.

EXTRA CHARGES

- size '100'
- ventilation sleeves or ventilation undercut
- black lock and black barrel hinges
- magnetic lock with stainless steel faceplate
- magnetic lock: black and black barrel hinges (for rebated doors)
- magnetic lock: white, black (for non-rebated doors)
- magnetic lock: gold
- OFFER - prime set without extra charge
- non-rebated door leaves: third 3D hinge, silver, white, black (extra charge to the door frame price)
- non-rebated doors: third 3D hinge, gold (extra charge added to door frame price)
- non-rebated door leaves: 3D hinges, gold (extra charge added to door frame price)
- sliding door leaves - oblong pull handle
- sliding door leaves - hook lock with side pull handles
- handle with an escutcheon

(p. 212)

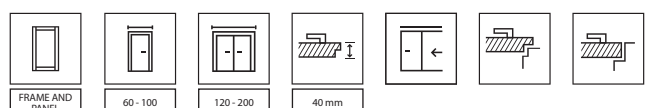



PORTA VERTE WWPREMIUM C.0, Andersen pine, EUFORIA handle black



MATCH THE DOOR TO FLOORS AND FURNITURE



IN YOUR FAVORITE COLOURS



AQUA STOP



model B.0



model B.1



model B.2



model B.3



EUFORIA handle



model C.0



model C.1



model C.2



flat panel



frosted glass

PORTA VERTE PREMIUM, group B and C

OPTIMUM ●●○

AVAILABLE FINISHES

Portasynchro 3D Veneer ♥♥♥◇◇◇◇◇



Portaperfect 3D Veneer ♥♥♥♥♥◇

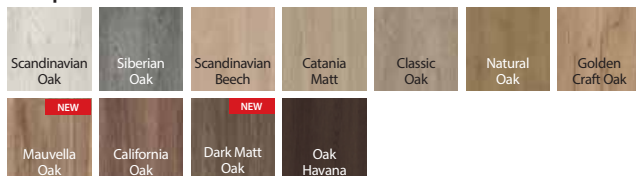

Portalamino ♥♥♥♥♥◇



TECHNICAL INFORMATION

DOOR LEAF CONSTRUCTION

Door leaves contain rails and stiles, slim panels and 6 mm thick, frosted, tempered glass. Combination of those depends on a model. Preparation for shortening maximum 60 mm. Size '100' requires third hinge.

ACCESSORIES

- lock: key lock, WC lock, cylinder lock
- rebated doors: three standard barrel hinges, or PRIME hinges
- non-rebated doors: two 3D hinges
- oblong pull handle for sliding doors

DOOR FRAMES

Recommended rebated door frames:

- PORTA SYSTEM p. 188
- MINIMAX p. 186
- STEEL door frames p. 198-203

Recommended non-rebated door frames:

- PORTA SYSTEM ELEGANCE p. 190
- PORTA SYSTEM ELEGANCE 90 degrees p. 190
- LEVEL p. 194

NOTES

- Norm PN EN 14351-2:2018-12.
- Double doors are available in any door leaf size combinations.
- Magnetic lock is not available for a double door.
- There are two door leaves (active and passive, sizes 60-100) in double leaf doors.
- PRIME hinges or 3D hinges – packed with the door frame.
- The lower surface of stiles are protected against humidity thanks to TechnoPORTA AQUA STOP.

EXTRA CHARGES

- size '100'
- ventilation sleeves or ventilation undercut
- black lock and black barrel hinges
- magnetic lock with stainless steel faceplate
- magnetic lock: black and black barrel hinges (for rebated doors)
- magnetic lock: white, black (for non-rebated doors)
- magnetic lock: gold
- OFFER - prime set without extra charge
- non-rebated door leaves: third 3D hinge, silver, white, black (extra charge to the door frame price)
- non-rebated doors: third 3D hinge, gold (extra charge added to door frame price)
- non-rebated door leaves: 3D hinges, gold (extra charge added to door frame price)
- sliding door leaves - oblong pull handle
- sliding door leaves - hook lock with side pull handles
- handle with an escutcheon

(p. 212)

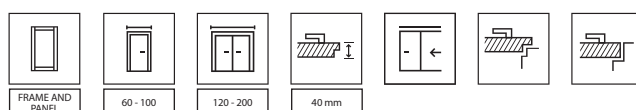



PORTA VERTE PREMIUM E.5, White, ELEGANT silver handle



MATCH THE DOOR TO FLOORS AND FURNITURE



IN YOUR FAVORITE COLOURS



AQUA STOP



model E.0



model E.1



model E.2



flat panel



model E.3



model E.4



model E.5



model E.5 with black glass panel



frosted glass



black glass panel

PORTA VERTE PREMIUM, group E

OPTIMUM ●●●

AVAILABLE FINISHES

Premium Lacquered Veneer ◆◆◆◆◆



Portadecor Veneer ◆◆◆◆◆



Portasynchro 3D Veneer ◆◆◆◆◆



Portaperfect 3D Veneer ◆◆◆◆◆

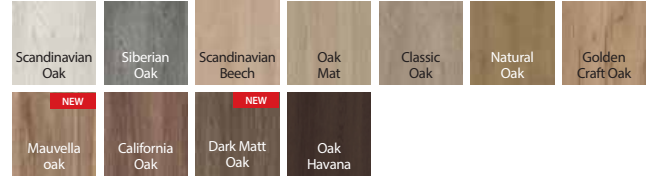

Portalamino ◆◆◆◆◆

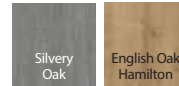

TECHNICAL INFORMATION

DOOR LEAF CONSTRUCTION

Door leaves contain rails and stiles, slim panels and 6 mm thick, frosted, tempered glass. Combination of those depends on a model. Preparation for shortening maximum 60 mm. Size '100' requires third hinge.

ACCESSORIES

- lock: key lock, WC lock, cylinder lock
- rebated doors: three standard barrel hinges, or PRIME hinges
- non-rebated doors: two 3D hinges
- oblong pull handle for sliding doors

DOOR FRAMES

Recommended rebated door frames:

- PORTA SYSTEM p. 188
- MINIMAX p. 186
- STEEL door frames p. 198-203

Recommended non-rebated door frames:

- PORTA SYSTEM ELEGANCE p. 190
- PORTA SYSTEM ELEGANCE 90 degrees p. 190
- LEVEL p. 194

NOTES

- Norm PN EN 14351-2:2018-12.
- Double doors are available in any door leaf size combinations.
- Magnetic lock is not available for a double door.
- There are two door leaves (active and passive, sizes 60-100) in double leaf doors.
- PRIME hinges or 3D hinges – packed with the door frame.
- The lower surface of stiles are protected against humidity thanks to TechnoPORTA AQUA STOP.

EXTRA CHARGES

- size '100'
 - ventilation sleeves or ventilation undercut
 - black glass panel 1 pc.
 - black lock and black barrel hinges
 - magnetic lock with stainless steel faceplate
 - magnetic lock: black and black barrel hinges (for rebated doors)
 - magnetic lock: white, black (for non-rebated doors)
 - magnetic lock: gold
 - OFFER - prime set
 - non-rebated door leaves: third 3D hinge, silver, white, black (extra charge to the door frame price)
 - non-rebated doors: third 3D hinge, gold (extra charge added to door frame price)
 - non-rebated door leaves: 3D hinges, gold (extra charge added to door frame price)
 - sliding door leaves - oblong pull handle
 - sliding door leaves - hook lock with side pull handles
 - handle with an escutcheon
- (p. 212)

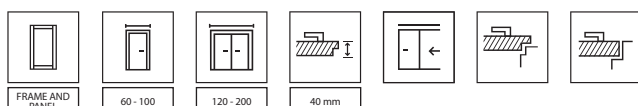



PORTA VERTE HOME B.5, Wenge White, handle ELEGANT black



MATCH THE DOOR TO FLOORS AND FURNITURE



IN YOUR FAVORITE COLOURS



AQUA STOP



model B.1



model B.2



model B.5



ELEGANT door handle



model D.0



model D.2



model D.7



model B.5 - dedicated frosted glass panel with transparent stripe



model D.0 decorative inlays



model D.7 decorative inlays



frosted tempered glass and decorative inlays- aluminium colour

AVAILABLE FINISHES

Premium Lacquered Veneer ◆◆◆◆◆◇



Portadecor Veneer ◆◆◆◆◆◇



Portasynchro 3D Veneer ◆◆◆◆◆◇



Portaperfect 3D Veneer ◆◆◆◆◆◇

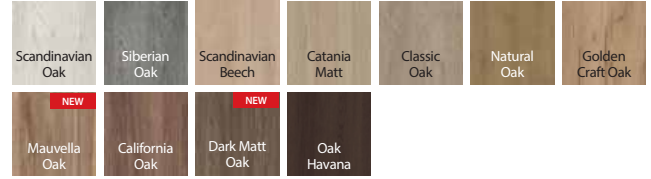

Portalamino ◆◆◆◆◆◇

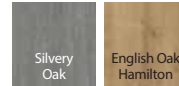

TECHNICAL INFORMATION

DOOR LEAF CONSTRUCTION

Door leaves contain rails, slim panels and 4 mm thick, frosted, tempered glass.
Combination of those depends on a model. Preparation for shortening (maximum 30 mm)
- Size '100' requires third hinge.

ACCESSORIES

- lock: key lock, WC lock, cylinder lock, handle only
- rebated doors: three standard barrel hinges or PRIME hinges (at extra charge)
- non-rebated doors: two 3D hinges
- oblong pull handle for sliding doors

DOOR FRAMES

Recommended rebated door frames:

- PORTA SYSTEM p. 188
- MINIMAX p. 186
- STEEL door frames see p. 198-203

Recommended non-rebated door frames:

- PORTA SYSTEM ELEGANCE p. 190
- PORTA SYSTEM ELEGANCE 90 degrees p. 190
- LEVEL p. 194

NOTES

- Norm PN EN 14351-2:2018-12.
- Double doors are available in any door leaf size combinations.
- Magnetic lock is not available for a double door.
- There are two door leaves (active and passive, sizes 60-100) in double leaf doors.
- PRIME hinges or 3D hinges – packed with the door frame.
- The lower surface of stiles are protected against humidity thanks to TechnoPORTA AQUA STOP.

EXTRA CHARGES

- size '100'
- ventilation sleeves or ventilation undercut
- PRIME hinges (for dedicated door frames)
- PRIME lock with glossy faceplate (silver or gold)
- black lock and black barrel hinges
- magnetic lock with stainless steel faceplate
- magnetic lock: black and black barrel hinges (for rebated doors)
- magnetic lock: white, black (for non-rebated doors)
- magnetic lock: gold
- non-rebated door leaves: third 3D hinge, silver, white, black (extra charge to the door frame price)
- non-rebated doors: third 3D hinge, gold (extra charge added to door frame price)
- non-rebated door leaves: 3D hinges, gold (extra charge added to door frame price)
- sliding door leaves - oblong pull handle
- sliding door leaves - hook lock with side pull handles
- handle with an escutcheon

(p. 212)

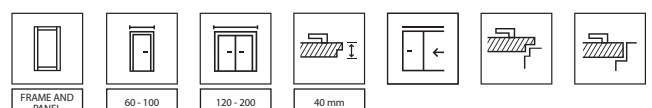



PORTA VERTE HOME C.5, Matt Oak, handle SIMPLE black



MATCH THE DOOR TO FLOORS AND FURNITURE



IN YOUR FAVORITE COLOURS



AQUA STOP



model C.0



model C.1



model C.2



SIMPLE handle



model C.3



model C.4



model C.5



decorative inlays - aluminium colour



model C.0 decorative inlays



model C.5 decorative inlays



frosted tempered glass

AVAILABLE FINISHES

Premium Lacquered Veneer ◆◆◆◆◆◆◆◆



Portadecor Veneer ◆◆◆◆◆◆◆◆



Portasynchro 3D Veneer ◆◆◆◆◆◆◆◆



Portaperfect 3D Veneer ◆◆◆◆◆◆◆◆

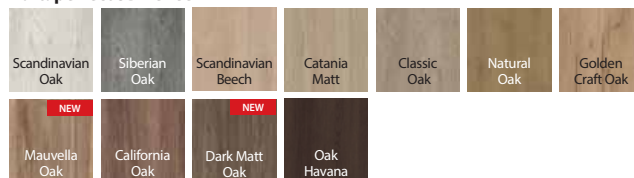

Portalamino ◆◆◆◆◆◆◆◆

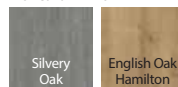

TECHNICAL INFORMATION

DOOR LEAF CONSTRUCTION

Door leaves contain rails, slim panels and 4 mm thick, frosted, tempered glass. Combination of those depends on a model. Preparation for shortening (maximum 30 mm)
 - Size '100' requires third hinge.

ACCESSORIES

- lock: key lock, WC lock, cylinder lock, handle only
- rebated doors: three standard barrel hinges or PRIME hinges (at extra charge)
- non-rebated doors: two 3D hinges
- oblong pull handle for sliding doors

DOOR FRAMES

Recommended rebated door frames:

- PORTA SYSTEM p. 188
- MINIMAX p. 186
- STEEL door frames see p. 198-203

Recommended non-rebated door frames:

- PORTA SYSTEM ELEGANCE p. 190
- PORTA SYSTEM ELEGANCE 90 degrees p. 190
- LEVEL p. 194

NOTES

- Norm PN EN 14351-2:2018-12.
- Double doors are available in any door leaf size combinations.
- Magnetic lock is not available for a double door.
- There are two door leaves (active and passive, sizes 60-100) in double leaf doors.
- PRIME hinges or 3D hinges – packed with the door frame.
- The lower surface of stiles are protected against humidity thanks to TechnoPORTA AQUA STOP.

EXTRA CHARGES

- size '100'
- ventilation sleeves or ventilation undercut
- PRIME hinges (for dedicated door frames)
- PRIME lock with glossy faceplate (silver or gold)
- black lock and black barrel hinges
- magnetic lock with stainless steel faceplate
- magnetic lock: black and black barrel hinges (for rebated doors)
- magnetic lock: white, black (for non-rebated doors)
- magnetic lock: gold
- non-rebated door leaves: third 3D hinge, silver, white, black (extra charge to the door frame price)
- non-rebated doors: third 3D hinge, gold (extra charge added to door frame price)
- non-rebated door leaves: 3D hinges, gold (extra charge added to door frame price)
- sliding door leaves - oblong pull handle
- sliding door leaves - hook lock with side pull handles
- handle with an escutcheon

(p. 212)

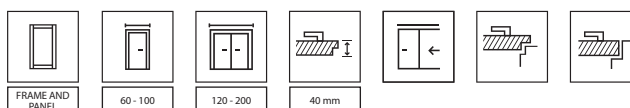



PORTA VERTE HOME M.1, Mauvella oak, ELEGANT handle black



MATCH THE DOOR TO FLOORS AND FURNITURE



IN YOUR FAVORITE COLOURS



AQUA STOP



model E.0



model E.1



model E.5



model E. blackboard



ELEGANT door handle



M.1 model



M.2 model



an option with a magnetic blackboard for drawing with chalk markers (this option is available for E.0 model for one side, rebated version only)



models of group M - transparent or frosted glass

PORTA VERTE HOME, group E and M

BUDGET ●●●

AVAILABLE FINISHES

Portadecor Veneer ♥♥♥♥♥



Portasynchro 3D Veneer ♥♥♥♥♥



Portaperfect 3D Veneer ♥♥♥♥♥

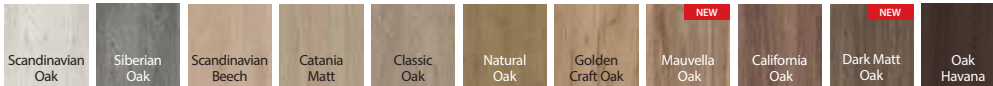

TECHNICAL INFORMATION

DOOR LEAF CONSTRUCTION

Door leaves contain rails, slim panels and 4 mm thick, frosted, tempered glass. Combination of those depends on a model. Model M is available with transparent glass. Preparation for shortening (maximum 30 mm). Size '100' requires third hinge.

ACCESSORIES

- lock: key lock, WC lock, cylinder lock, handle only
- rebated doors: three standard barrel hinges or PRIME hinges (at extra charge)
- non-rebated doors: two 3D hinges
- oblong pull handle for sliding doors

DOOR FRAMES

Recommended rebated door frames:

- PORTA SYSTEM p. 188
- MINIMAX p. 186
- STEEL door frames see p. 198-203

Recommended non-rebated door frames:

- PORTA SYSTEM ELEGANCE p. 190
- PORTA SYSTEM ELEGANCE 90 degrees p. 190
- LEVEL p. 194

NOTES

- Norm PN EN 14351-2:2018-12.
- Double doors are available in any door leaf size combinations.
- Magnetic lock is not available for a double door.
- There are two door leaves (active and passive, sizes 60-100) in double leaf doors.
- Model E.0 with the blackboard is not available in size '100'.
- PRIME hinges or 3D hinges – packed with the door frame.
- The lower surface of stiles are protected against humidity thanks to TechnoPORTA AQUA STOP.

EXTRA CHARGES

- size '100'
- ventilation sleeves or ventilation undercut
- PRIME hinges (for dedicated door frames)
- PRIME lock with glossy faceplate (silver or gold)
- black lock and black barrel hinges
- magnetic lock with stainless steel faceplate
- magnetic lock: black and black barrel hinges (for rebated doors)
- magnetic lock: white, black (for non-rebated doors)
- magnetic lock: gold
- non-rebated door leaves: third 3D hinge, silver, white, black (extra charge to the door frame price)
- non-rebated doors: third 3D hinge, gold (extra charge added to door frame price)
- non-rebated door leaves: 3D hinges, gold (extra charge added to door frame price)
- sliding door leaves - oblong pull handle
- sliding door leaves - hook lock with side pull handles
- handle with an escutcheon

(p. 212)

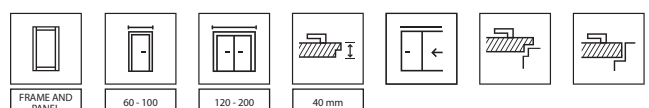



PORTA VERTE HOME G.4, White, ELEGANT handle black



MATCH THE DOOR TO FLOORS AND FURNITURE



IN YOUR FAVORITE COLOURS



AQUA STOP



model G.0



model G.1



model G.2



ELEGANT door handle



model G.3



model G.4



model G.4 with black glass panels



glazing, model G.4



model G.0 decorative inlays



model G.4 decorative inlays



Decorative slat (Portaperfect finish) is recessed in comparison to the surface of a doorleaf panel. Vertical graining is optional at extra charge.

AVAILABLE FINISHES

Portadecor Veneer ◆◆◆◆◆



Portasynchro 3D Veneer ◆◆◆◆◆



Portaperfect 3D Veneer ◆◆◆◆◆

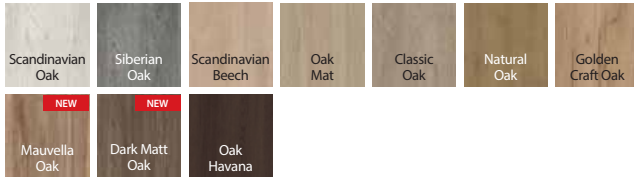

AVAILABLE FINISHES OF DECORATIVE SLATS

Portaperfect 3D Veneer ◆◆◆◆◆



Brushed aluminum



TECHNICAL INFORMATION

DOOR LEAF CONSTRUCTION

Door leaves contain rails, slim panels and 4 mm thick, frosted, tempered glass. Combination of those depends on a model. Preparation for shortening (maximum 30 mm). Size '100' requires third hinge.

FINISH

For models in white finishes you can choose decorative slats in two options: Portaperfect Veneer or brushed aluminium (at extra charge).

ACCESSORIES

- lock: key lock, WC lock, cylinder lock, handle only
- rebated doors: three standard barrel hinges or PRIME hinges (at extra charge)
- non-rebated doors: two 3D hinges
- oblong pull handle for sliding doors

DOOR FRAMES

Recommended rebated door frames:

- PORTA SYSTEM p. 188
- MINIMAX p. 186
- STEEL door frames see p. 198-203

Recommended non-rebated door frames:

- PORTA SYSTEM ELEGANCE p. 190
- PORTA SYSTEM ELEGANCE 90 degrees p. 190
- LEVEL p. 194

NOTES

- Norm PN EN 14351-2:2018-12.
- Double doors are available in any door leaf size combinations.
- Magnetic lock is not available for a double door.
- There are two door leaves (active and passive, sizes 60-100) in double leaf doors.
- PRIME hinges or 3D hinges – packed with the door frame.
- The lower surface of stiles are protected against humidity thanks to TechnoPORTA AQUA STOP.

EXTRA CHARGES

- size '100'
- ventilation sleeves or ventilation undercut
- black glass panel 1 pc.
- decorative slat: brushed aluminum – white door leaf
- decorative slat finished with Portaperfect Veneer - white door leaf
- PRIME hinges (for dedicated door frames)
- PRIME lock with glossy faceplate (silver or gold)
- black lock and black barrel hinges
- magnetic lock with stainless steel faceplate
- magnetic lock: black and black barrel hinges (for rebated doors)
- magnetic lock: white, black (for non-rebated doors)
- magnetic lock: gold
- non-rebated door leaves: third 3D hinge, silver, white, black (extra charge to the door frame price)
- non-rebated doors: third 3D hinge, gold (extra charge added to door frame price)
- non-rebated door leaves: 3D hinges, gold (extra charge added to door frame price)
- sliding door leaves - oblong pull handle
- sliding door leaves - hook lock with side pull handles
- handle with an escutcheon

(p. 212)

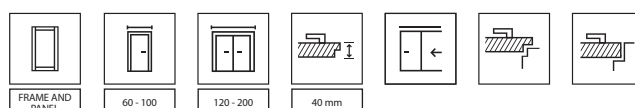



PORTA VERTE HOME H.5, Natural Oak, handle NEXT silver



MATCH THE DOOR TO FLOORS AND FURNITURE



IN YOUR FAVORITE COLOURS



AQUA STOP



model H.0



model H.1



model H.2



EUFORIA handle



model H.3



model H.4



model H.5



model H.5 with black glazing

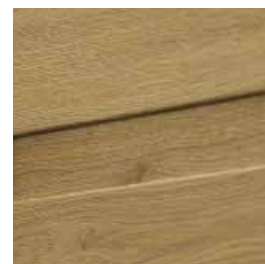

model H.0 - slim panel



Model H.0 - decorative slat (Portaperfect finish) is recessed in comparison to the surface of a doorleaf panel. Vertical graining is optional (at extra charge).

AVAILABLE FINISHES

Portadecor Veneer



Portasynchro 3D Veneer



Portaperfect 3D Veneer



AVAILABLE FINISHES OF DECORATIVE SLATS

Portaperfect 3D Veneer

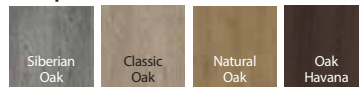

Brushed aluminum



TECHNICAL INFORMATION

DOOR LEAF CONSTRUCTION

Door leaves contain rails, slim panels and 4 mm thick, frosted, tempered glass. Combination of those depends on a model. Preparation for shortening (maximum 30 mm). Size '100' requires third hinge.

FINISH

For models in white finishes you can choose decorative slats in two options: Portaperfect Veneer or brushed aluminium (at extra charge).

ACCESSORIES

- lock: key lock, WC lock, cylinder lock, handle only
- rebated doors: three standard barrel hinges or PRIME hinges (at extra charge)
- non-rebated doors: two 3D hinges
- oblong pull handle for sliding doors

DOOR FRAMES

Recommended rebated door frames:

- PORTA SYSTEM p. 188
- MINIMAX p. 186
- STEEL door frames p. 198-203

Recommended non-rebated door frames:

- PORTA SYSTEM ELEGANCE p. 190
- PORTA SYSTEM ELEGANCE 90 degrees p. 190
- LEVEL p. 194

NOTES

- Norm PN EN 14351-2:2018-12.
- Double doors are available in any door leaf size combinations.
- Magnetic lock is not available for a double door.
- There are two door leaves (active and passive, sizes 60-100) in double leaf doors.
- PRIME hinges or 3D hinges – packed with the door frame.
- The lower surface of stiles are protected against humidity thanks to TechnoPORTA AQUA STOP.

EXTRA CHARGES

- size '100'
- ventilation sleeves or ventilation undercut
- black glass panel 1 pc.
- decorative slat: brushed aluminum – white door leaf
- decorative slat finished with Portaperfect Veneer - white door leaf
- PRIME hinges (for dedicated door frames)
- PRIME lock with glossy faceplate (silver or gold)
- black lock and black barrel hinges
- magnetic lock with stainless steel faceplate
- magnetic lock: black and black barrel hinges (for rebated doors)
- magnetic lock: white, black (for non-rebated doors)
- magnetic lock: gold
- non-rebated door leaves: third 3D hinge, silver, white, black (extra charge to the door frame price)
- non-rebated doors: third 3D hinge, gold (extra charge added to door frame price)
- non-rebated door leaves: 3D hinges, gold (extra charge added to door frame price)
- sliding door leaves - oblong pull handle
- sliding door leaves - hook lock with side pull handles
- handle with an escutcheon

(p. 212)

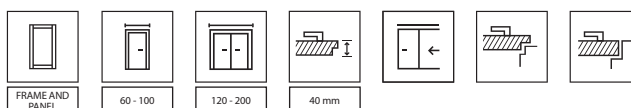



PORTA VERTE HOME J.6, White, handle EUFORIA black



MATCH THE DOOR TO FLOORS AND FURNITURE



IN YOUR FAVORITE COLOURS



AQUA STOP



model J.0



model J.1



model J.2



model J.6 - glazing



model J.4



model J.5



model J.6



model J.6 with black glass panel



flat panel, model J.0



Model J.0 - decorative slat (Portaperfect finish) is recessed in comparison to the surface of a door leaf panel. Vertical graining is optional (at extra charge).

AVAILABLE FINISHES

Portadecor Veneer ♥♥♥♥♥



Portasynchro 3D Veneer ♥♥♥♥♥



Portaperfect 3D Veneer ♥♥♥♥♥

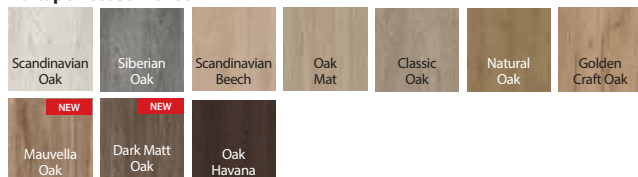

AVAILABLE FINISHES OF DECORATIVE SLATS

Portaperfect 3D Veneer ♥♥♥♥♥

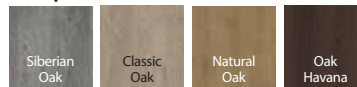

Brushed aluminum



TECHNICAL INFORMATION

DOOR LEAF CONSTRUCTION

Door leaves contain rails, slim panels and 4 mm thick, frosted, tempered glass. Combination of those depends on a model. Preparation for shortening (maximum 30 mm). Size '100' requires third hinge.

FINISH

For models in white finishes you can choose decorative slats in two options: Portaperfect Veneer or brushed aluminium (at extra charge).

ACCESSORIES

- lock: key lock, WC lock, cylinder lock, handle only
- rebated doors: three standard barrel hinges or PRIME hinges (at extra charge)
- non-rebated doors: two 3D hinges
- oblong pull handle for sliding doors

DOOR FRAMES

Recommended rebated door frames:

- PORTA SYSTEM p. 188
- MINIMAX p. 186
- STEEL door frames p. 198-203

Recommended non-rebated door frames:

- PORTA SYSTEM ELEGANCE p. 190
- PORTA SYSTEM ELEGANCE 90 degrees p. 190
- LEVEL p. 194

NOTES

- Norm PN EN 14351-2:2018-12.
- Double doors are available in any door leaf size combinations.
- Magnetic lock is not available for a double door.
- There are two door leaves (active and passive, sizes 60-100) in double leaf doors.
- PRIME hinges or 3D hinges – packed with the door frame.
- The lower surface of stiles are protected against humidity thanks to TechnoPORTA AQUA STOP.

EXTRA CHARGES

- size '100'
- ventilation sleeves or ventilation undercut
- black glass panel 1 pc.
- decorative slat: brushed aluminum – white door leaf
- decorative slat finished with Portaperfect Veneer - white door leaf
- PRIME hinges (for dedicated door frames)
- PRIME lock with glossy faceplate (silver or gold)
- black lock and black barrel hinges
- magnetic lock with stainless steel faceplate
- magnetic lock: black and black barrel hinges (for rebated doors)
- magnetic lock: white, black (for non-rebated doors)
- magnetic lock: gold
- non-rebated door leaves: third 3D hinge, silver, white, black (extra charge to the door frame price)
- non-rebated doors: third 3D hinge, gold (extra charge added to door frame price)
- non-rebated door leaves: 3D hinges, gold (extra charge added to door frame price)
- sliding door leaves - oblong pull handle
- sliding door leaves - hook lock with side pull handles
- handle with an escutcheon

(p. 212)

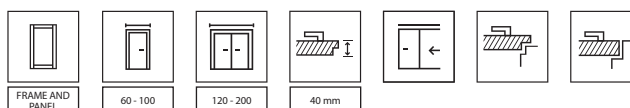



PORTA VERTE HOME N.3, Silver Acacia, handle ELEGANT black



MATCH THE DOOR TO FLOORS AND FURNITURE



IN YOUR FAVORITE COLOURS



AQUA STOP



model L.0



model L.1



model L.2



model L.3



ELEGANT door handle



model N.0



model N.1



model N.2



model N.3



model L.0 - slim panel



model N.0 - slim panel

AVAILABLE FINISHES

Portadecor Veneer ♥♥♥♥♥



Portasynchro 3D Veneer ♥♥♥♥♥



Portaperfect 3D Veneer ♥♥♥♥♥

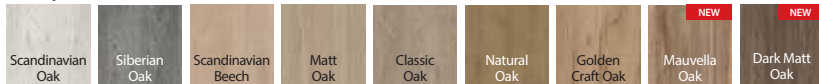

TECHNICAL INFORMATION

DOOR LEAF CONSTRUCTION

Door leaves contain rails, slim panels and 4 mm thick, frosted, tempered glass. Combination of those depends on a model. Preparation for shortening (maximum 30 mm)
 - Size '100' requires third hinge.

ACCESSORIES

- lock: key lock, WC lock, cylinder lock, handle only
- rebated doors: three standard barrel hinges or PRIME hinges (at extra charge)
- non-rebated doors: two 3D hinges
- oblong pull handle for sliding doors

DOOR FRAMES

Recommended rebated door frames:

- PORTA SYSTEM p. 188
- MINIMAX p. 186
- STEEL door frames see p. 198-203

Recommended non-rebated door frames:

- PORTA SYSTEM ELEGANCE p. 190
- PORTA SYSTEM ELEGANCE 90 degrees p. 190
- LEVEL p. 194

NOTES

- Norm PN EN 14351-2:2018-12.
- Double doors are available in any door leaf size combinations.
- Magnetic lock is not available for a double door.
- There are two door leaves (active and passive, sizes 60-100) in double leaf doors.
- PRIME hinges or 3D hinges – packed with the door frame.
- The bottom surface of the vertical stiles is protected against moisture with Techno PORTA AQUA STOP technology.

EXTRA CHARGES

- size '100'
- ventilation sleeves or ventilation undercut
- PRIME hinges (for dedicated door frames)
- PRIME lock with glossy faceplate (silver or gold)
- black lock and black barrel hinges
- magnetic lock with stainless steel faceplate
- magnetic lock: black and black barrel hinges (for rebated doors)
- magnetic lock: white, black (for non-rebated doors)
- magnetic lock: gold
- non-rebated door leaves: third 3D hinge, silver, white, black (extra charge to the door frame price)
- non-rebated doors: third 3D hinge, gold (extra charge added to door frame price)
- non-rebated door leaves: 3D hinges, gold (extra charge added to door frame price)
- sliding door leaves - oblong pull handle
- sliding door leaves - hook lock with side pull handles
- handle with an escutcheon

(p. 212)

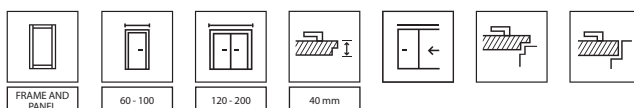



PORTA UNI Colour MODERN with black glass panel, Cashmere Matt, door handle DIVO FIT Q black



SAFE LAMINATED
GLASS PANEL



EVERY DETAIL
MATTERS



DURABLE
FINISH



model 1.1



model 4.A



MODERNO HANDLE



model H.1



model F.1



model L.1



model I.1



black decorative inlay
silver and golden inlays
are also available

AVAILABLE FINISHES

Matt Lacquered Veneer ▼▼▼▼▼



TECHNICAL INFORMATION

DOOR LEAF CONSTRUCTION

Honeycomb or hollow chipboard core reinforced with rails and stiles (at extra charge). The construction is skinned with HDF. Chipboard core have preparation for shortening as a standard. Size '100' and '110' and reinforcement for a door closer require third hinge. Size '110' available only with chipboard core.

FINISH

Door leaves are complemented with decorative inlays in silver, golden or black colour, width 6 mm. Glazed model comes with forsted, laminated safety glass 8 mm thick or with black glass (option at extra charge).

ACCESSORIES

- rebated doors: - Two or three standard barrel hinges or PRIME hinges (optionally at extra charge)
- non-rebated doors: two 3D hinges
- lock: key lock, WC lock, or cylinder lock
- oblong pull handle for sliding doors

DOOR FRAMES

Recommended rebated door frames:

- PORTA SYSTEM p. 188

Recommended non-rebated door frames:

- PORTA SYSTEM ELEGANCE p. 190
- PORTA SYSTEM ELEGANCE 90 degrees p. 190

NOTES

- Norm PN EN 14351-2:2018-12.
- Double doors are available in any door leaf size combinations.
- Magnetic lock is not available for a double door.
- Passive leaf sizes: from '60' to '100' Passive door leaves (side panels) in sizes '30', '40', '50' available only in solid option (without decorative applications).
- There are two door leaves (active and passive, sizes 60-100) in double leaf doors.
- Size '110' is not available for model 4.A.
- Fixed size of glass, model 4.A.
- PRIME hinges or 3D hinges – packed with the door frame.

EXTRA CHARGES

- black glass panel - model 4.A
- size '100', '110'
- preparation for shortening (max. 60 mm)
- hollow chipboard core
- chipboard core
- undercut, ventilation sleeves
- automatic threshold seal (not available for model 4.A)
- PRIME hinges (for dedicated door frames)
- PRIME lock with glossy faceplate (silver or gold)
- black lock and black barrel hinges
- magnetic lock with stainless steel faceplate
- magnetic lock: white, black (for non-rebated doors)
- magnetic lock: black and black barrel hinges (for rebated doors)
- magnetic lock: gold
- non-rebated door leaves: third 3D hinge, silver, white, black (extra charge to the door frame price)
- non-rebated doors: third 3D hinge, gold (extra charge added to door frame price)
- non-rebated door leaves: 3D hinges, gold (extra charge added to door frame price)
- sliding door leaves - oblong pull handle
- sliding door leaves - hook lock with side pull handles
- reinforcement for a door closer requires third hinge
- handle with an escutcheon

(p. 212)

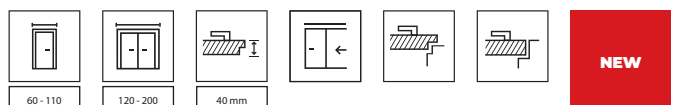



PORTA RESIST 1.1, Casella Natural Oak, door handle DIVO FIT black



MATCH THE DOOR TO FLOORS AND FURNITURE



WOOD TEXTURE



AQUA STOP



DURABLE FINISH



DURABLE EDGE



SURFACE RESISTANT TO SCRUBBING

vertical graining:



model 1.1



model 1.2



model 1.3



model 1.4



DIVO FIT handle, black

horizontal graining:



model 7.1



model 7.2



model 7.3



model 7.4

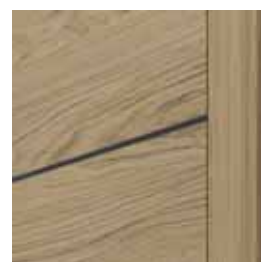

black decorative inlay
silver decorative inlays also available

vertical or horizontal graining:



model B.1*



model E.1*



model H.1*

vertical graining:



model 4.A black glazing also available



model 4.B



glazing in model 4.A, black glass panel also available - option at extra charge

* graining according to the direction of the decorative inlays

AVAILABLE FINISHES

Gladstone / Halifax ♥♥♥♥♥♥♥♥



K Check the possibilities of ordering bespoke door models through PORTA CONTRACT.

WE RECOMMEND!

The door leaf is skinned with a highly compressed board with very fine fibres structure. Thanks to its high density, the board guarantees resistance to impacts, attritions and scratches.

WE RECOMMEND!

Investment set- check the details p. 102

TECHNICAL INFORMATION

DOOR LEAF CONSTRUCTION

Honeycomb or chipboard core reinforced with rails and stiles (at extra charge). Models 1.4, 1.7 - solid chipboard core, 4.B - hollow chipboard core. The construction is skinned with HDF 4.A and 4.B models come with 8 mm thick, laminated safety glass, which is an element of the construction. Chipboard core have preparation for shortening as a standard. Size '110' is available only with chipboard. Glazing size is the same as for size, '100'. Reinforcement for a door closer and sizes '100' and '110' require third hinge.

FINISH

There is lipping ABS on the side edges. Models with decorative Inlays - black or silver, 6 mm wide.
Glazing - models of gr. 1 and 7 'chinchilla' glass; frosted tempered glass; transparent glass. Models of gr. 4 - 8 mm thick frosted, laminated safety glass. Black glazing is available for model 4.A (optionally at extra charge).
The door leaf is skinned with a Gladstone/Halifax board (with structure), a door frame is finished with matching CPL Veneer 0,2 mm.

ACCESSORIES

- rebated doors: two or three barrel hinges standard or PRIME.
- non-rebated doors: two 3D hinges
- lock: key lock, WC lock, or cylinder lock
- oblong pull handle for sliding doors

DOOR FRAMES

Recommended rebated door frames:

- PORTA SYSTEM p. 188
- MINIMAX p. 186
- STEEL door frames see p. 198-203

Recommended non-rebated door frames:

- PORTA SYSTEM ELEGANCE p. 190
- PORTA SYSTEM ELEGANCE 90 degrees p. 190

NOTES

- Norm PN EN 14351-2:2018-12.
- Ventilation grille, ventilation sleeves and preparation for shortening are not available for group 4.
- Size '100' and '110' is not available for models 1.4, 7.4.
- Size '110' is not available for models of gr. 4.
- Fixed size of glass, model 4.A
- Double doors are available in any door leaf size combinations.

- Magnetic lock is not available for a double door.
- Passive leaf sizes: from '60' to '100' Passive door leaves (side panels) in sizes '30', '40', '50' available only in solid option (without decorative applications).
- There are two door leaves (active and passive, sizes 60-100) in double leaf doors.
- Size '80' and '90' in investment norm (clear opening width 800, 900 mm) available as a standard (applies to gr. 1 and 7) - without extra charge.
- PRIME hinges or 3D hinges - packed with the door frame.
- Lower edge protected against humidity with TechnoPORTA AQUA STOP technology.

EXTRA CHARGES

- size '100', '110'
- preparation for shortening (max. 60 mm) - apart from group 4
- hollow chipboard core
- chipboard core
- ventilation undercut, sleeves or ventilation grille
- automatic threshold seal
- stainless steel porthole - model 1.1, 1.7
- black porthole
- black glass panel - model 4.A
- inverse glazing without extra charge
- black lock and black barrel hinges
- magnetic lock with stainless steel faceplate
- magnetic lock: black and black barrel hinges (for rebated doors)
- magnetic lock: white, black (for non-rebated doors)
- magnetic lock: gold
- OFFER - prime set without extra charge
- non-rebated door leaves: third 3D hinge, silver, white, black (extra charge to the door frame price)
- non-rebated doors: third 3D hinge, gold (extra charge added to door frame price)
- non-rebated door leaves: 3D hinges, gold (extra charge added to door frame price)
- sliding door leaves - oblong pull handle
- sliding door leaves - hook lock with side pull handles
- investment set (extra charge added to a door frame)
- investment set (extra charge added to a door leaf)
- reinforcement for a door closer requires third hinge handle with an escutcheon

(p. 212)

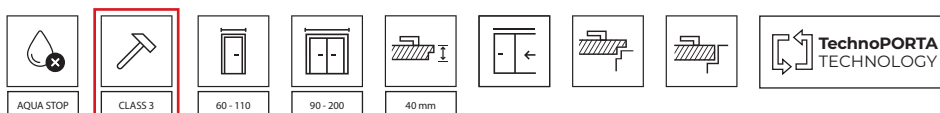



PORTA FOCUS 4.A, Natural Walnut (matt), handle CUBE black



MATCH THE DOOR TO FLOORS AND FURNITURE



IN YOUR FAVORITE COLOURS



SAFETY LAMINATED GLASS



DURABLE EDGE



SURFACE RESISTANT TO SCRUBBING



CERTIFIED CPL



model 4.A



model 4.A with black glazing



CUBE handle



model 2.0



model 4.B



glass - door panel joint rebated door leaf



glass - door panel joint non-rebated door leaf

AVAILABLE FINISHES

Portadecor Veneer ♥♥♥♥♥

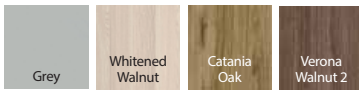

Portasynchro 3D Veneer ♥♥♥♥♥



Portaperfect 3D Veneer ♥♥♥♥♥

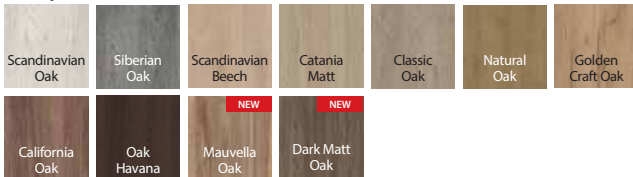

CPL HQ 0,2 laminate ♥♥♥♥♥

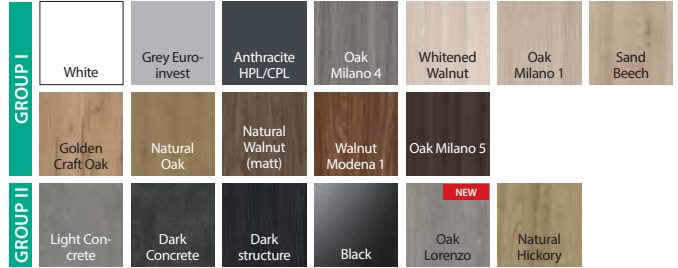

Portalamino ♥♥♥♥♥

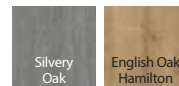

Matt Lacquered Veneer ♥♥♥♥♥



TECHNICAL INFORMATION

DOOR LEAF CONSTRUCTION

Honeycomb or hollow chipboard core reinforced with rails and stiles (at extra charge). The construction is skinned with HDF. Size '110' is available only with hollow chipboard. Sizes '100' and '110' require third hinge.

FINISH

Glazed models come with 8 mm thick, frosted laminated safety glass panel. Black glazing is available for model 4.A (optionally at extra charge). There is lipping ABS on the side edges of the doors finished with CPL.

ACCESSORIES

- rebated doors: two or three barrel hinges standard or PRIME
- non-rebated doors: two 3D hinges
- lock: key lock, WC lock, or cylinder lock
- oblong pull handle for sliding doors

DOOR FRAMES

Recommended rebated door frames:

- PORTA SYSTEM p. 188
- MINIMAX p. 186
- STEEL door frames p. 198-203

Recommended non-rebated door frames:

- PORTA SYSTEM ELEGANCE p. 190
- PORTA SYSTEM ELEGANCE 90 degrees p. 190
- LEVEL p. 194

NOTES

- Norm PN EN 14351-2:2018-12.
- Double doors are available in any door leaf size combinations.
- Magnetic lock is not available for a double door.
- Passive leaf sizes: from '60' to '100' Passive door leaf, sizes: '30'; '40'; '50' (so called side panel) only as solid option
- There are two door leaves for non-rebated double leaf set: active and passive. Sizes: 60-100.

- 4.B models are available only with hollow chipboard core, free of extra charge.
- Size '110' is not available for models of group 4
- Fixed size of glass - group 2, model 4.A.
- PRIME hinges or 3D hinges – packed with the door frame.

EXTRA CHARGES

- size '100', '110'
- hollow chipboard core
- chipboard core
- CPL finish 0,2 mm - GROUP II
- ventillation undercut, sleeves or ventilation grille
- black glass panel - model 4.A
- PRIME hinges (for dedicated door frames)
- PRIME lock with glossy faceplate (silver or gold)
- black lock and black barrel hinges
- magnetic lock with stainless steel faceplate
- magnetic lock: white, black (for non-rebated doors)
- magnetic lock: black and black barrel hinges (for rebated doors)
- magnetic lock: gold
- OFFER - prime set without extra charge
- non-rebated door leaves: third 3D hinge, silver, white, black (extra charge to the door frame price)
- non-rebated doors: third 3D hinge, gold (extra charge added to door frame price)
- non-rebated door leaves: 3D hinges, gold (extra charge added to door frame price)
- sliding door leaves - oblong pull handle
- sliding door leaves - hook lock with side pull handles
- handle with an escutcheon

(p. 212)

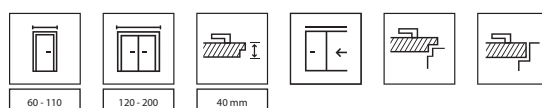



PORTA LOFT, 1.1, Halifax Tabak, ELEGANT handle black



MATCH THE DOOR TO FLOORS AND FURNITURE



WOOD TEXTURE



SAFETY LAMINATED GLASS



EVERY DETAIL MATTERS



DURABLE EDGE



SURFACE RESISTANT TO SCRUBBING



CERTIFIED CPL

Halifax Tabak with black door frame



model 7.1



model 1.1



model 4.A - black glazing is also available



model 4.B



ELEGANT door handle

Halifax Natural with white door frame



model 7.1



model 1.1



model 4.A



model 4.B

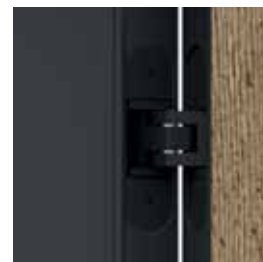

3D hinges in the colour of the door frame



glass-door panel joint

AVAILABLE FINISHES

CPL HQ 0,2 laminate ◆◆◆◆◆◆◆◆

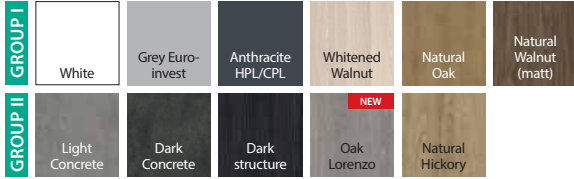

Matt Lacquered Veneer ◆◆◆◆◆◆◆◇



Portaperfect 3D Veneer ◆◆◆◆◆◆◇◇

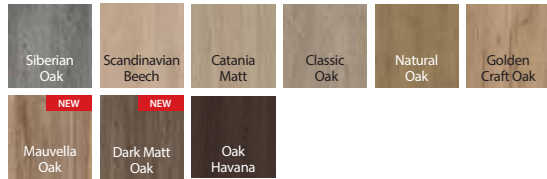

Gladstone / Halifax ◆◆◆◆◆◆◆◆

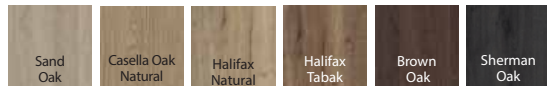

AVAILABLE FINISHES OF DOOR FRAMES

CPL HQ 0,2 laminate ◆◆◆◆◆◆◆◆



SUPER MATT Veneer ◆◆◆◆◆◆◇◇



TECHNICAL INFORMATION

DOOR LEAF CONSTRUCTION

Honeycomb or hollow chipboard core reinforced with rails and stiles (at extra charge). The construction is skinned with HDF. Chipboard core have preparation for shortening as a standard. Size '100' requires third hinge.

FINISH

Glazed models come with 8 mm thick, frosted laminated safety glass panel. Black glazing is available model 4.A (optionally at extra charge). The distinctive feature of this collection is black or white lipping ABS on the side edges.

ACCESSORIES

- two 3D hinges in a door frame colour- Black or White
- lock in ABS tape colour - Black or White

DOOR FRAME

- PORTA SYSTEM ELEGANCE, black or white.
- PORTA SYSTEM ELEGANCE 90 degrees, black or white.
- Steel PORTA SYSTEM ELEGANCE, black or white.

NOTES

- Norm PN EN 14351-2:2018-12.
- 4.B model is available only with chipboard core, (free of extra charge).
- Fixed size of glass, model 4.A
- 3D hinges - packed with a door frame
- Key lock - dedicated striker in the frame.

EXTRA CHARGES

- size '100'
- preparation for shortening (max. 60 mm) - model 1.1
- hollow chipboard core
- chipboard core
- CPL finish 0,2 mm - GROUP II
- ventilation undercut
- automatic threshold seal
- black glass panel - model 4.A
- third 3D hinge (extra charge added to a door frame price)
- handle with an escutcheon

(p. 212)

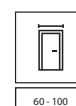



PORTA LEVEL C.2, Catania Oak. Dedicated door frame LEVEL with top panel 100 cm, handle AZALIA black



EVERY DETAIL MATTERS



model C.1
Door frame with top panel 20 cm



model C.2 with a decorative inlay
Door frame with the top panel- 20 cm.



model C.3 with a decorative inlay
Door frame with the top panel- 20 cm.



RUMBA handle



black decorative inlays



silver decorative inlays

PLEASE NOTE

The PORTA LEVEL collection, together with the LEVEL door frame, provide unusual possibilities for interior design.
The top panel Level is available with two graining directions – horizontal or vertical - Applies to 6 chosen finishes.

AVAILABLE FINISHES

Portadecor Veneer ♥♥♥♥♥



Portaperfect 3D Veneer ♥♥♥♥♥

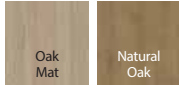

Portalamino ♥♥♥♥♥

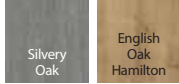

TECHNICAL INFORMATION

DOOR LEAF CONSTRUCTION

Honeycomb or chipboard core reinforced with rails and stiles (option at extra charge). The construction is skinned with HDF. Chipboard core have preparation for shortening as a standard. Reinforcement for a door closer and size '100' require third hinge.

ACCESSORIES

- rebated doors: - Two or three standard barrel hinges or PRIME hinges (optionally at extra charge)
- non-rebated doors: two 3D hinges
- lock: key lock, WC lock, or cylinder lock

DOOR FRAMES

Recommended rebated door frames:

- PORTA SYSTEM p. 188
- MINIMAX p. 186
- STEEL door frames p. 198-203

Recommended non-rebated door frames:

- PORTA SYSTEM ELEGANCE p. 190
- PORTA SYSTEM ELEGANCE 90 degrees p. 190
- LEVEL p. 194

NOTES

- Norm PN EN 14351-2:2018-12.
- Double doors are available in any door leaf size combinations.
- Magnetic lock is not available for a double door.
- Passive leaf sizes: from '60' to '100' Passive door leaf, sizes: '30'; '40'; '50' (so called side panel) only as solid option.
- There are two door leaves (active and passive, sizes 60-100) in double leaf doors.
- PRIME or - 3D hinges - packed with a door frame.

EXTRA CHARGES

- size '100'
- preparation for shortening (max. 60 mm)
- hollow chipboard core
- chipboard core
- undercut, ventilation sleeves
- automatic threshold seal
- PRIME hinges (for dedicated door frames)
- PRIME lock with glossy faceplate (silver or gold)
- black lock and black barrel hinges
- magnetic lock with stainless steel faceplate
- magnetic lock: white, black (for non-rebated doors)
- magnetic lock: black and black barrel hinges (for rebated doors)
- magnetic lock: gold
- non-rebated door leaves: third 3D hinge, silver, white, black (extra charge to the door frame price)
- non-rebated doors: third 3D hinge, gold (extra charge added to door frame price)
- non-rebated door leaves: 3D hinges, gold (extra charge added to door frame price)
- sliding door leaves - oblong pull handle
- sliding door leaves - hook lock with side pull handles
- reinforcement for a door closer requires third hinge
- handle with an escutcheon

(p. 212)

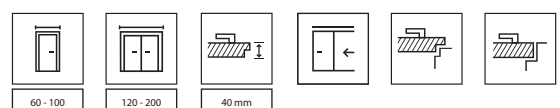



PORTA NOVA 2.1, Silvery Oak, handle SIMPLE silver



MATCH THE DOOR
TO FLOORS AND
FURNITURE



model 2.1



model 2.2



model 2.2 with
mirror



model 3.1



ACCENT PLUS door handle,
decorative moulding with
a slim panel



model 3.2



model 4.1



model 4.2



model 4.4



model 5.1



model 5.2



model 5.4



model 5.5

AVAILABLE FINISHES

Portadecor Veneer ♥♥♥♥♥

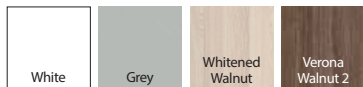

Portasynchro 3D Veneer ♥♥♥♥♥



Portaperfect 3D Veneer ♥♥♥♥♥

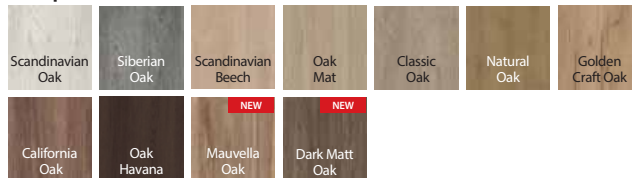

Portalamino ♥♥♥♥♥

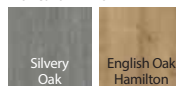

TECHNICAL INFORMATION

DOOR LEAF CONSTRUCTION

Chipboard core reinforced with rails and stiles. The construction is skinned with HDF. Size '100' and reinforcement for a door closer require third hinge. Preparation for shortening - maximum 60 mm (group 2 and 3 only).

FINISH

Model 2.2 is available with a mirror on one or on both sides. If the mirror is only on one side, there will be slim panel on the other side. Glazing - 'chinchilla' glass or frosted tempered glass (at extra charge).

ACCESSORIES

- lock: key lock, WC lock, or cylinder lock
- rebated doors: three standard barrel hinges or PRIME hinges (at extra charge)
- non-rebated doors: two 3D hinges
- oblong pull handle for sliding doors

DOOR FRAMES

Recommended rebated door frames:

- PORTA SYSTEM p. 188
- MINIMAX p. 186
- STEEL door frames p. 198-203

Recommended non-rebated door frames:

- PORTA SYSTEM ELEGANCE p. 190
- PORTA SYSTEM ELEGANCE 90 degrees p. 190
- LEVEL p. 194

NOTES

- Norm PN EN 14351-2:2018-12.
- Double doors are available in any door leaf size combinations.
- Magnetic lock is not available for a double door.
- Passive leaf sizes: from '60' to '100' Passive door leaves (side panels) in sizes '30', '40', '50' available only in solid option (without decorative applications).
- There are two door leaves for non-rebated double leaf set: active and passive. Sizes: 60-100.
- Model 2.2 is not available in size, 100'
- PRIME hinges or 3D hinges – packed with the door frame.

EXTRA CHARGES

- size '100'
 - ventilation undercut, sleeves or ventilation grille
 - automatic threshold seal
 - mirror on both sides
 - mirror on one side
 - inverse glazing
 - frosted glass – thickness 4 and 5 (for 1 pc. of glass panel)
 - frosted glass, model 2
 - frosted glass, model 3
 - PRIME hinges (for dedicated door frames)
 - PRIME lock with glossy faceplate (silver or gold)
 - black lock and black barrel hinges
 - magnetic lock with stainless steel faceplate
 - magnetic lock: white, black (for non-rebated doors)
 - magnetic lock: black and black barrel hinges (for rebated doors)
 - magnetic lock: gold
 - non-rebated door leaves: third 3D hinge, silver, white, black (extra charge to the door frame price)
 - non-rebated doors: third 3D hinge, gold (extra charge added to door frame price)
 - non-rebated door leaves: 3D hinges, gold (extra charge added to door frame price)
 - sliding door leaves - oblong pull handle
 - sliding door leaves - hook lock with side pull handles
 - handle with an escutcheon
- without extra charge
- (p. 212)

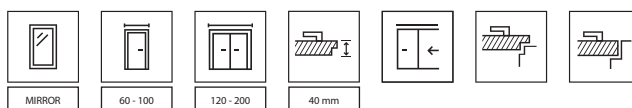



PORTA LINE L.1, Lorenzo Oak, Divo Fit Q, handle black



MATCH THE DOOR TO FLOORS AND FURNITURE



WOOD TEXTURE



AQUA STOP



DURABLE FINISH



DURABLE EDGE



SURFACE RESISTANT TO SCRUBBING



CERTIFIED CPL



model A.1



model B.1



model C.1



model E.1



model F.1



Divo Fit Q handle, black

NEW

NEW



model G.1



model H.1



model I.1



model L.1



black decorative inlays also available silver and gold inlays

AVAILABLE FINISHES

Portadecor Veneer ◆◆◆◆◆



Portasyntro 3D Veneer ◆◆◆◆◆



Portaperfect 3D Veneer ◆◆◆◆◆

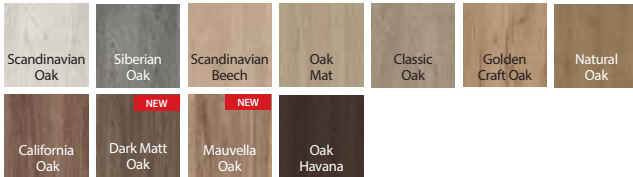

CPL HQ 0,2 laminate ◆◆◆◆◆

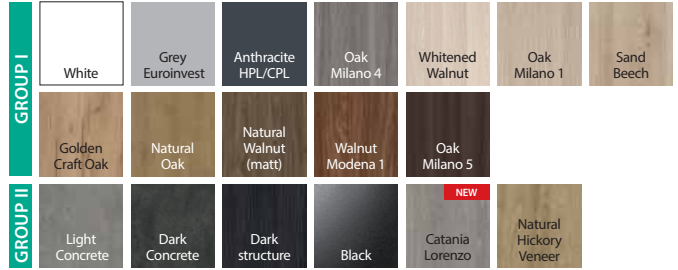

Portalamino ◆◆◆◆◆



Matt Lacquered Veneer ◆◆◆◆◆



WE RECOMMEND!

Investment set- check the details p. 102

TECHNICAL INFORMATION

DOOR LEAF CONSTRUCTION

Honeycomb or hollow chipboard core reinforced with rails and stiles (at extra charge). The construction is skinned with HDF. Chipboard core have preparation for shortening as a standard. Size '100' and '110' and reinforcement for a door closer require third hinge.

FINISH

Door leaves are complemented with decorative inlays in silver, golden or black colour, width 6 mm. There is lipping ABS on the side edges of the doors finished with CPL HQ. Sliding option of models F.1 and G.1 - decorative inlays placed on pull handle height.

ACCESSORIES

- rebated doors: - Two or three standard barrel hinges or PRIME hinges (optionally at extra charge)
- non-rebated doors: two 3D hinges
- lock: key lock, WC lock, or cylinder lock
- oblong pull handle for sliding doors

DOOR FRAMES

Recommended rebated door frames:

- PORTA SYSTEM p. 188
- MINIMAX p. 186
- STEEL door frames p. 198-203

Recommended non-rebated door frames:

- PORTA SYSTEM ELEGANCE p. 190
- PORTA SYSTEM ELEGANCE 90 degrees p. 190
- LEVEL p. 194

NOTES

- Norm PN EN 14351-2:2018-12.
- Size '110' is available only with chipboard core.
- Double doors are available in any door leaf size combinations.
- Magnetic lock is not available for a double door.
- Passive leaf sizes: from '60' to '100' Passive door leaves (side panels) in sizes '30', '40', '50' available only in solid option (without decorative applications).
- There are two door leaves for non-rebated double leaf set: active and passive. Sizes: 60-100.
- PRIME hinges or 3D hinges – packed with the door frame.
- Lower edge protected against humidity with TechnoPORTA AQUA STOP technology.

EXTRA CHARGES

- size '100', '110'
- preparation for shortening (max. 60 mm)
- hollow chipboard core
- chipboard core
- CPL finish 0,2 mm - GROUP II
- undercut, ventilation sleeves
- automatic threshold seal
- PRIME hinges (for dedicated door frames)
- PRIME lock with glossy faceplate (silver or gold)
- black lock and black barrel hinges
- magnetic lock with stainless steel faceplate
- magnetic lock: white, black (for non-rebated doors)
- magnetic lock: black and black barrel hinges (for rebated doors)
- magnetic lock: gold
- OFFER - doors with CPL finish - PRIME set without extra charge
- non-rebated door leaves: third 3D hinge, silver, white, black (extra charge to the door frame price)
- non-rebated doors: third 3D hinge, gold (extra charge added to door frame price)
- non-rebated door leaves: 3D hinges, gold (extra charge added to door frame price)
- sliding door leaves - oblong pull handle
- sliding door leaves - hook lock with side pull handles
- investment set (extra charge added to a door frame)
- investment set (extra charge added to a door leaf)
- reinforcement for a door closer requires third hinge handle with an escutcheon

(p. 212)

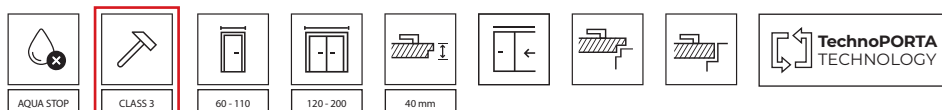



PORTA CPL 1.1, Natural Hickory, handle MAXIMA black



MATCH THE DOOR TO FLOORS AND FURNITURE



WOOD TEXTURE



AQUA STOP



DURABLE FINISH



DURABLE EDGE



SURFACE RESISTANT TO SCRUBBING



CERTIFIED CPL



model 1.1



model 1.2



model 1.3



ELEGANT door handle



model 1.4



model 1.5



glazing bead with a glass panel

AVAILABLE FINISHES

	CPL HQ 0,2 laminate ◆◆◆◆◆◆◆◆				CPL HQ 0,7 laminate ◆◆◆◆◆◆◆◆		
GROUP I	White	Grey Euroinvest	Anthracite HPL/CPL	Oak Milano 4	Whitened Walnut	Oak Milano 1	Sand Beech
	Golden Craft-Oak	Natural Oak	Natural Walnut (matt)	Walnut Modena 1	Oak Milano 5		
GROUP II	Light Concrete	Dark Concrete	Dark structure	Black	Oak Lorenzo NEW	Natural Hickory	

 Check the possibilities of ordering bespoke door models through PORTA CONTRACT.

WE RECOMMEND!

Investment set- check the details p. 102

TECHNICAL INFORMATION

DOOR LEAF CONSTRUCTION

Group 1 - honeycomb, hollow chipboard core or chipboard (at extra charge) reinforced with rails and stiles. Model 1.4 - chipboard core. The construction is skinned with HDF. Chipboard core have preparation for shortening as a standard. Size '110' is available only with chipboard. Glazing size is the same as for size, '100'. Size '100' and '110' and reinforcement for a door closer require third hinge.

FINISH

There is lipping ABS on the side edges. Glazing - 'chinchilla' glass or frosted/transparent tempered glass (optionally at an extra charge). All of the stainless steel panels are available only for sizes: 80, 90, 100, for doors with hollow chipboard core or chipboard core.

ACCESSORIES

- lock: key lock, WC lock, or cylinder lock
- rebated doors: two or three barrel hinges standard or PRIME.
- non-rebated doors: two 3D hinges
- oblong pull handle for sliding doors

DOOR FRAMES

Recommended rebated door frames:

- PORTA SYSTEM p. 188
- MINIMAX p. 186
- STEEL door frames p. 198-203

Recommended non-rebated door frames:

- PORTA SYSTEM ELEGANCE p. 190
- PORTA SYSTEM ELEGANCE 90 degrees p. 190

NOTES

- Norm PN EN 14351-2:2018-12.
- Size '100' and '110' is not available for model 1.4.
- Double doors are available in any door leaf size combinations.
- Magnetic lock is not available for a double door.
- Passive leaf sizes: from '60' to '100' Passive door leaves (side panels) in sizes '30', '40', '50' available only in solid option (without decorative applications).
- There are two door leaves (active and passive, sizes 60-100) in double leaf doors.
- Size '80' and '90' in investment norm (clear opening width 800, 900 mm) available as a standard- without extra charge.
- PRIME hinges or 3D hinges – packed with the door frame.
- Lower edge protected against humidity with TechnoPORTA AQUA STOP technology.

EXTRA CHARGES

- size '100'
- size '110' - rebated doors only
- preparation for shortening (max. 60 mm)
- hollow chipboard core
- chipboard core
- CPL finish 0,2 mm - CPL 0,2 and 0,7 mm - GROUP II
- ventillation undercut, sleeves or ventilation grille
- automatic threshold seal
- stainless steel porthole - model 1.1
- black porthole
- OFFER - prime set without extra charge
- transparent/frosted glazing - model 1.2
- frosted, transparent glass - model 1.3 and 1.4
- transparent/frosted glazing - model 1.5
- black lock and black barrel hinges
- magnetic lock with stainless steel faceplate
- magnetic lock: white, black (for non-rebated doors)
- magnetic lock: black and black barrel hinges (for rebated doors)
- magnetic lock: gold
- OFFER - prime set without extra charge
- non-rebated door leaves: third 3D hinge, silver, white, black (extra charge to the door frame price)
- non-rebated doors: third 3D hinge, gold (extra charge added to door frame price)
- non-rebated door leaves: 3D hinges, gold (extra charge added to door frame price)
- sliding door leaves - oblong pull handle
- sliding door leaves - hook lock with side pull handles
- investment set (extra charge added to a door frame)
- investment set (extra charge added to a door leaf)
- kick panel - set for two sides (models 1.1 - 1.3)
- ventilation kick panel - set for two sides (models 1.1 - 1.3)
- kick panel with a ventilation undercut - set for two sides (models 1.1 - 1.3)
- push panel - set. for two sides (models 1.1, 1.2)
- reinforcement for a door closer requires third hinge handle with an escutcheon (p. 212)

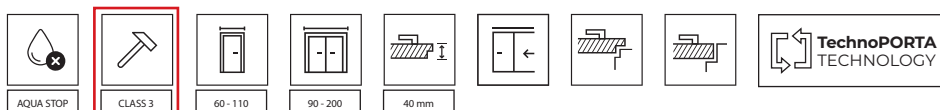



PORTA CPL 1.1, Black, handle ELEGANT black



THE MOST POPULAR MODELS

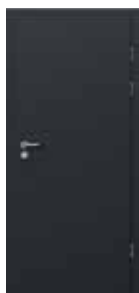

model 1.1



model 1.2



model 1.5



automatic threshold seal

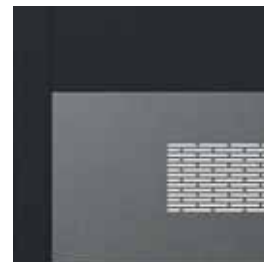

ventilation kick panel



push panel

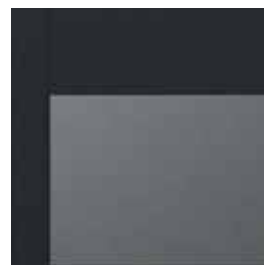

kick panel

Investment set is available in closed door models with chipboard core:

- PORTA CPL,
- PORTA RESIST,
- PORTA LINE (finish: CPL, Portalamio),
- PORTA DECOR (finish Portalamio),
- Nature CLASSIC.

Investment set is available with a rebated door frame: PORTA SYSTEM, Steel PORTA SYSTEM, Steel Adjustable, Corner profile SMALL PLUS and LARGE

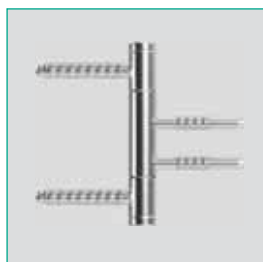

3 part hinges for PORTA SYSTEM door frame - technical placement

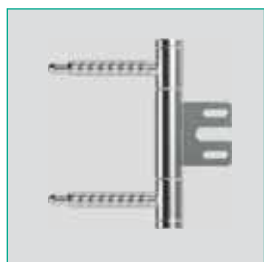

3 part hinges for a steel door frame - technical placement



lock of the highest 3rd category of use according to PN-EN 12209

AVAILABLE FINISHES - PORTA CPL

	CPL HQ 0,2 laminate ♥♥♥♥♥♥♥♥					CPL HQ 0,7 laminate ♥♥♥♥♥♥♥♥	
GROUP I	White	Grey Euroinvest	Anthracite HPL/CPL	Oak Milano 4	Whitened Walnut	Oak Milano 1	Sand Beech
	Golden Craft Oak	Natural Oak	Natural Walnut (matt)	Walnut Modena 1	Oak Milano 5		
GROUP II	Light Concrete	Dark Concrete	Dark structure	Black	Catania Lorenzo <small>NEW</small>	Natural Hickory	

WE RECOMMEND

'Investment set' additionally available. It contains 3 part hinges and lock of the highest category of use (at extra charge). Set consists of a door leaf and a dedicated door frame.



Check the possibilities of ordering bespoke door models through PORTA CONTRACT.

TECHNICAL INFORMATION PORTA CPL

DOOR LEAF CONSTRUCTION

Hollow chipboard core or chipboard core reinforced with rails and stiles. The construction is skinned with HDF. Lipping ABS on the side edges.

ACCESSORIES

- lock: key lock, WC lock, or cylinder lock
- rebated doors: two or three 3 part hinges (hinges are the part of door frame accessories).
- glazing - 'chinchilla' glass or frosted/transparent tempered glass (optionally at extra charge)
- preparation for shortening (max. 60 mm)

DOOR FRAMES

Recommended rebated door frames:

- PORTA SYSTEM p. 188
- STEEL door frames p. 198-203

NOTES

- Norm PN EN 14351-2:2018-12.
- Glazing size for size '110' is the same as for size '100'.
- Double doors are available in any door leaf size combinations.
- Passive door leaf (standard) is available for sizes from '60' to '100'.
- Passive door leaf (side panel) - sizes '30', '40', '50' is available only as a solid option.
- Possibilities of ordering bespoke door models through PORTA CONTRACT
- **Door leaf with PORTA SYSTEM of a steel door frame - technical placement of hinges.**
- **Size '80' and '90' in investment norm (clear opening width 800, 900 mm) available as a standard- without extra charge.**

- All of the stainless steel panels are available only for sizes: 80, 90, 100.
- Thanks to TechnoPORTA AQUA STOP technology door leaves have lower edges protected against humidity.

EXTRA CHARGES

- size '100', '110'
- replacing hollow chipboard core with solid chipboard core
- CPL finish 0,2 mm - CPL 0,2 and 0,7 mm - GROUP II
- ventilation undercut, sleeves or ventilation grille
- automatic threshold seal
- stainless steel porthole - model 1.1
- black porthole
- inverse glazing without extra charge
- transparent/frosted glazing - model 1.2
- transparent/frosted glazing - model 1.5
- investment set (extra charge added to a door frame)
- kick panel - set for two sides (models 1.1 - 1.2)
- ventilation kick panel - set for two sides (models 1.1 - 1.2)
- kick panel with a ventilation undercut - set for two sides (models 1.1 - 1.2)
- push panel - set. for two sides (models 1.1, 1.2)
- reinforcement for a door closer requires third hinge
- handle with an escutcheon (p. 212)

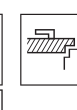
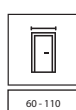



PORTA DECOR P, Gray, DORO handle black



MATCH THE DOOR TO FLOORS AND FURNITURE



AQUA STOP



DURABLE EDGE



model P



model M



model D



model L



EUFORIA handle



Chinchilla' glass panel'



ABS lipping on side edges

AVAILABLE FINISHES

Portadecor Veneer ♥♥♥♥♥



Portaperfect 3D Veneer ♥♥♥♥♥

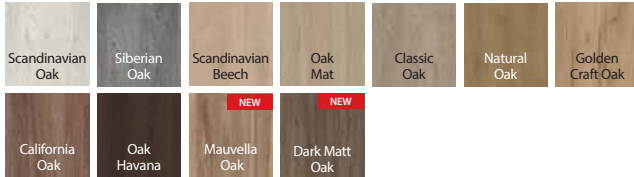

Matt Lacquered Veneer ♥♥♥♥♥



Lacquered matt Veneer available only for model P.

Portasynchro 3D Veneer ♥♥♥♥♥



Portalamino ♥♥♥♥♥



WE RECOMMEND!

Investment set- check the details p. 102

TECHNICAL INFORMATION

DOOR LEAF CONSTRUCTION

Honeycomb or hollow chipboard core reinforced with rails and stiles (at extra charge). The construction is skinned with HDF. Chipboard core have preparation for shortening as a standard. Reinforcement for a door closer and sizes '100' and '110' require third hinge.

FINISH

There is **liping ABS on the side edges.**

Glazing - 'chinchilla' glass or frosted tempered glass (optionally at extra charge)

ACCESSORIES

- rebated doors: - Two or three standard barrel hinges or PRIME hinges (optionally at extra charge)
- non-rebated doors: two 3D hinges
- lock: key lock, WC lock, or cylinder lock
- oblong pull handle for sliding doors

DOOR FRAMES

Recommended rebated door frames:

- PORTA SYSTEM p. 188
- MINIMAX p. 186
- STEEL door frames see p. 198-203

Recommended non-rebated door frames:

- PORTA SYSTEM ELEGANCE p. 190
- PORTA SYSTEM ELEGANCE 90 degrees p. 190
- LEVEL p. 194

NOTES

- Norm PN EN 14351-2:2018-12.
- Size, '110' is available only with hollow chipboard. Glazing size is the same as for size '100'.
- Double doors are available in any door leaf size combinations.
- Magnetic lock is not available for a double door.
- Passive leaf sizes: from '60' to '100' Passive door leaves (side panels) in sizes '30', '40', '50' available only in solid option (without decorative applications).
- There are two door leaves for non-rebated double leaf set: active and passive. Sizes: 60-100.
- Size '80' and '90' in investment norm (clear opening width 800, 900 mm) available as a standard- without extra charge.
- PRIME hinges or 3D hinges – packed with the door frame.

EXTRA CHARGES

- Black ABS liping for any door leaf finish size '100', '110'
- preparation for shortening (max. 60 mm)
- hollow chipboard core
- chipboard core
- ventilation undercut, sleeves or ventilation grille
- automatic threshold seal
- stainless steel porthole
- black porthole
- inverse glazing without extra charge
- frosted tempered glass - model D
- frosted tempered glass - model L
- frosted tempered glass - model M
- PRIME hinges (for dedicated door frames)
- PRIME lock with glossy faceplate (silver or gold)
- black lock and black barrel hinges
- magnetic lock with stainless steel faceplate
- magnetic lock: white, black (for non-rebated doors)
- magnetic lock: black and black barrel hinges (for rebated doors)
- magnetic lock: gold
- non-rebated door leaves: third 3D hinge, silver, white, black (extra charge to the door frame price)
- non-rebated doors: third 3D hinge, gold (extra charge added to door frame price)
- non-rebated door leaves: 3D hinges, gold (extra charge added to door frame price)
- sliding door leaves - oblong pull handle
- sliding door leaves - hook lock with side pull handles
- investment set (extra charge added to a door frame)
- investment set (extra charge added to a door leaf)
- reinforcement for a door closer requires third hinge
- handle with an escutcheon (p. 212)

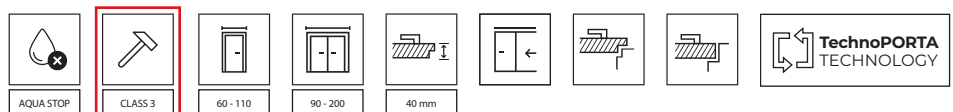



PORTA FIT I.1, Matt Oak, EUFORIA handle black



MATCH THE DOOR TO FLOORS AND FURNITURE



DURABLE EDGE



CERTIFIED CPL



PORTA FIT model G.0



PORTA FIT model G.3



PORTA FIT model G.5



ACCENT PLUS handle



PORTA FIT model H.0



PORTA FIT model H.4



PORTA FIT model I.0



PORTA FIT model I.1



glazing bead with a raised panel
NOTE: in case of CPL Veneer the bead is rounded



PORTA STYL model 1



PORTA STYL model 2



PORTA STYL model



glazed model

AVAILABLE FINISHES

Portadecor Veneer ◆◆◆◆◆



Portasynchro 3D Veneer ◆◆◆◆◆



Portaperfect 3D Veneer ◆◆◆◆◆

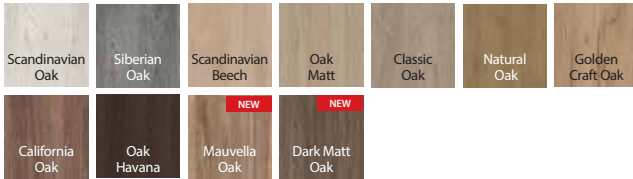

CPL HQ 0,2 laminate ◆◆◆◆◆



TECHNICAL INFORMATION

DOOR LEAF CONSTRUCTION

Honeycomb or chipboard core reinforced with rails and stiles (option at extra charge). The construction is skinned with HDF. Chipboard core have preparation for shortening as a standard. Reinforcement for a door closer and sizes '100' and '110' require third hinge.

FINISH

There is lipping ABS on the side edges of the doors finished with CPL HQ. Frosted frosted glass or 'chinchilla' glass.

ACCESSORIES

- rebated doors: - Two or three standard barrel hinges or PRIME hinges (optionally at extra charge)
- non-rebated doors: two 3D hinges
- lock: key lock, WC lock, or cylinder lock
- oblong pull handle for sliding doors

DOOR FRAMES

Recommended rebated door frames:

- PORTA SYSTEM p. 188
- MINIMAX p. 186
- STEEL door frames p. 198-203

Recommended non-rebated door frames:

- PORTA SYSTEM ELEGANCE p. 190
- PORTA SYSTEM ELEGANCE 90 degrees p. 190
- LEVEL p. 194

NOTES

- Norm PN EN 14351-2:2018-12.
- Double doors are available in any door leaf size combinations.
- Magnetic lock is not available for a double door.
- Passive leaf sizes: from '60' to '100' Passive door leaves (side panels) in sizes '30', '40', '50' available only in solid option (without decorative applications).
- There are two door leaves for non-rebated double leaf set: active and passive. Sizes: 60-100.
- Size '110' is available only with hollow chipboard. Glazing size is the same as for size '100' - applies to PORTA STYL
- Ventilation grille, 2 rows of ventilation sleeves are not available for H model - regards PORTA FIT.
- PRIME hinges or 3D hinges - packed with the door frame.

EXTRA CHARGES

- size '100', '110'
- preparation for shortening (max. 60 mm)
- hollow chipboard core
- chipboard core
- CPL finish 0,2 mm - GROUP II
- ventillation undercut, sleeves or ventilation grille
- automatic threshold seal
- inverse glazing without extra charge
- PRIME hinges (for dedicated door frames)
- PRIME lock with glossy faceplate (silver or gold)
- black lock and black barrel hinges
- magnetic lock with stainless steel faceplate
- magnetic lock: white, black (for non-rebated doors)
- magnetic lock: black and black barrel hinges (for rebated doors)
- magnetic lock: gold without extra charge
- OFFER - doors with CPL finish - PRIME set without extra charge
- non-rebated door leaves: third 3D hinge, silver, white, black (extra charge to the door frame price)
- non-rebated doors: third 3D hinge, gold (extra charge added to door frame price)
- non-rebated door leaves: 3D hinges, gold (extra charge added to door frame price)
- sliding door leaves - oblong pull handle
- sliding door leaves - hook lock with side pull handles
- reinforcement for a door closer requires third hinge handle with an escutcheon (p. 212)

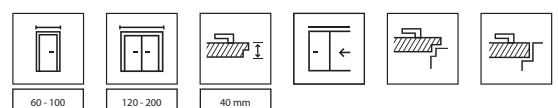



PORTA DECOR BASIC, Grey, with CORNER PROFILE BASIC steel door frame - LARGE, handle EDEL



CERTIFIED
CPL



Porta CPL
BASIC



Porta DECOR
BASIC



PORTA VERTE
BASIC



Corner profile BASIC steel door frame



ADJUSTABLE STEEL door frame
BASIC

Indications for use of BASIC flush doors: as interior doors in residential buildings and public buildings. Due to its strength properties, the door can be used in conditions corresponding to the 2nd class of mechanical class according to PN-EN 1192:2001, i.e. in light, medium operating conditions.

MATCH A HANDLE TO THE SET



EDEL | Class 3
stainless steel



Cylinder, WC lock

or



OVAL | class 4
stainless steel



handle, key lock, cylinder, WC lock

CPL BASIC, DECOR BASIC, VERTE BASIC

BUDGET ●●○

AVAILABLE FINISHES OF PORTA VERTE BASIC

Lacquered board ♥♥♥♥♥



AVAILABLE FINISHES OF PORTA CPL BASIC

CPL HQ 0,2 laminate ♥♥♥♥♥

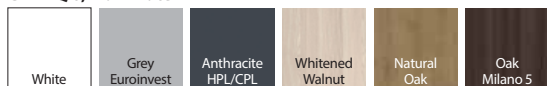

AVAILABLE FINISHES OF PORTA DECOR BASIC

Portadecor Veneer ♥♥♥♥♥



Portasynchro 3D Veneer ♥♥♥♥♥



TECHNICAL INFORMATION

DOOR LEAF CONSTRUCTION

Door frame made of MDF. Honeycomb or hollow chipboard core (at an extra charge for CPL BASIC and DECOR BASIC). The construction is skinned with HDF. Side edges are taped in line with a door leaf colour.

ACCESSORIES

- two or three standard barrel hinges
- lock: key lock, WC lock, or cylinder lock

DOOR FRAMES

Recommended rebated door frames:

- CORNER PROFILE BASIC, ADJUSTABLE STEEL BASIC, p. 196

NOTES

- Norm PN EN 14351-2:2018-12.
- Hollow chipboard core and chipboard core have preparation for shortening as a standard (up to 4 cm).
- Size '110' is available only with chipboard core.
- Size '110' is not available for VERTE BASIC.
- Size '80' and '90' in investment norm (clear opening width 800, 900 mm) available as a standard, without extra charge - not available for VERTE BASIC.
- Sizes, 100' and, 110' require third hinge.
- Thanks to TechnoPORTA AQUA STOP technology door leaves have lower edges protected against humidity.

CPL BASIC:

- Reinforcement for a door closer requires third hinge. Option available with hollow chipboard core, in sizes '60' - '100'.

EXTRA CHARGES

CPL BASIC, DECOR BASIC, VERTE BASIC
ventilation grille, ventilation sleeves or ventilation undercut
size '100', '110'*
hollow chipboard core*

* Size '110' and chipboard core not available for VERTE BASIC

CPL BASIC

reinforcement for a door closer
reinforcement for a door closer - size '100'

VERTE BASIC

tempered frosted glass - model: large glazing
tempered glass - model: lift
tempered frosted glass - model: small glazing
preparation for shortening
reinforcement for a door closer

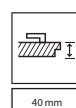



Nature CLASSIC 1.1, Walnut, grain - 'flower', handle AZURA black



NATURAL VENEER
FINISH



ECOLOGICAL
WATER VARNISHES

vertical graining:



model 1.1



model 1.2



model 1.3



model 1.4

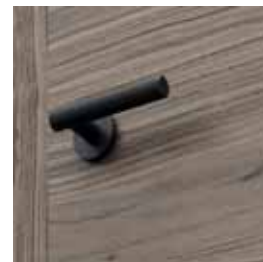

AZURA door handle

horizontal graining:



model 7.1



model 7.2



model 7.3



model 7.4



model 1.1
HEIGHT 220



model 3.1

AVAILABLE FINISHES

Natural Satin Oak Veneer ◆◆◆◆◆

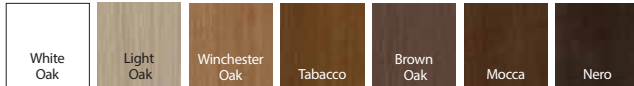

Natural Veneer - Select ◆◆◆◆◆

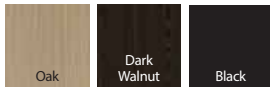

Natural Veneer ◆◆◆◆◆

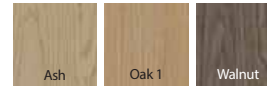

Ash and Walnut Veneer is available only for models of group 1 and 3. Grain - 'flower'.

K Customize colours to meet your individual needs. Send an enquiry through PORTA CONTRACT.

Due to the characteristic of natural veneers, differences in colour and graining, might appear on a door leaf. These differences cannot be grounds for complaints.

WE RECOMMEND!

Investment set- check the details p. 102

TECHNICAL INFORMATION

DOOR LEAF CONSTRUCTION

Core - stabilising infi II reinforced with rails and stiles. Hollow chipboard core available at an extra charge. Preparation for shortening maximum 60 mm. Height 220 - available for models 1.1 and 1.7; core: hollow chipboard, 3 hinges as a standard.

FINISH

The construction is skinned with a slim particle board which is finished with high quality Natural Veneer. The door leaf surface is protected by ecological water-based varnishes. Select, Natural Oak, Ash, Walnut and Satin (apart from white) veneers are hardened under UV lamp (semi-matt). Unvarnished door leaves are available in a standard product price. Model 3.1 is not available with Natural Satin Veneer. Glazing pattern: "chinchilla" or frosted tempered glass.

ACCESSORIES

- rebated doors: three standard barrel hinges, or PRIME hinges
- non-rebated and reversed rebate doors: two 3D hinges
- lock: key lock, WC lock, or cylinder lock
- oblong pull handle for sliding doors

DOOR FRAMES

Recommended rebated door frames:

- PORTA SYSTEM p. 188
- MINIMAX p. 186
- STEEL door frames p. 198-203

Recommended non-rebated door frames:

- PORTA SYSTEM ELEGANCE p. 190
- PORTA SYSTEM ELEGANCE 90 degrees p. 190

Recommended door frames with reversed rebate:

- PORTA SYSTEM with reversed rebate p. 192

NOTES

- Norm PN EN 14351-2:2018-12.
- Size '100' not available for model 1.3.
- Ventilation sleeves - silver or gold. 1 row
- Double doors are available in any door leaf size combinations
- Magnetic lock is not available for a double door.
- Passive door leaf is available for sizes from '60' to '100'.
- There are two door leaves for non-rebated double leaf set: active and passive.
- Sizes: 60-100.
- PRIME hinges or 3D hinges - packed with the door frame.

EXTRA CHARGES

- size '100'
- door leaf height 220 cm
- hollow chipboard core
- finishing with Natural Veneer: Oak Satin White
- finishing with Natural Veneer: Select Black
- undercut, ventilation sleeves 1 row - ventilation sleeves 2 rows (only for models 1.1, 1.2, 1.3)
- stainless steel porthole - model 1.1, 1.7
- black porthole
- mirror on both sides
- mirror on one side
- black lock and black barrel hinges
- magnetic lock with stainless steel faceplate
- magnetic lock: white, black (for non-rebated doors)
- magnetic lock: black and black barrel hinges (for rebated doors)
- magnetic lock: gold
- non-rebated door leaves: third 3D hinge, silver, white, black (extra charge to the door frame price)
- non-rebated doors: third 3D hinge, gold (extra charge added to door frame price)
- non-rebated door leaves: 3D hinges, gold (extra charge added to door frame price)
- reversed rebate - extra charge added to door leaf price
- reversed rebate - third 3D hinge, white, black (extra charge added to door frame price)
- reversed rebate - third 3D hinge, silver (extra charge added to door frame price)
- reversed rebate - 3D gold hinges (extra charge added to door frame price)
- reversed rebate - third 3D hinge, gold (extra charge added to door frame price)
- sliding door leaves - oblong pull handle
- sliding door leaves - hook lock with side pull handles
- investment set (extra charge added to a door frame)
- investment set (extra charge added to a door leaf)
- handle with an escutcheon

(p. 212)

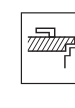
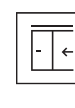
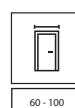
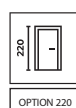



Nature VECTOR W, Winchester Oak, ELEGANT black handle



NATURAL VENEER FINISH



EVERY DETAIL MATTERS



ECOLOGICAL WATER VARNISHES

NEW

NEW



model J



model K



model L



ELEGANT door handle

NEW



model U



model V



model W

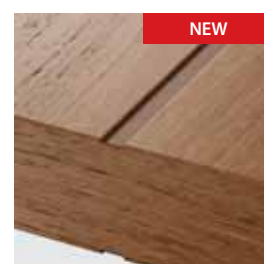

NEW

Decorative milling close up - visible texture of Natural oak. Wide milling.

NEW

NEW



model B



model E



model F



model G



Decorative milling close up - visible texture of Natural oak. Narrow milling.

AVAILABLE FINISHES

Natural Oak Satin Veneer ♥♥♥♥♥



Natural Veneer ♥♥♥♥♥



K Give free rein to your imagination! Do you have your own door concept? You can order any milling with PORTA CONTRACT.

Due to the characteristic of natural veneers, differences in colour and graining, might appear on a door leaf. These differences cannot be grounds for complaints.

TECHNICAL INFORMATION

DOOR LEAF CONSTRUCTION

Core - stabilising infi II reinforced with rails and stiles. Hollow chipboard core available at an extra charge. Preparation for shortening maximum 60 mm. Height '220': core - hollow chipboard; 3 hinges as a standard. The 3rd hinge is required for the 'reinforcement for door closer' option.

FINISH

The construction is skinned with a slim particle board which is finished with high quality Natural Veneer. The door leaf surface is protected by ecological water-based varnishes.

ACCESSORIES

- rebated doors: three standard barrel hinges, or PRIME hinges
- non-rebated doors: two 3D hinges
- lock: key lock, WC lock, or cylinder lock
- oblong pull handle for sliding doors

DOOR FRAMES

Recommended rebated door frames:

- PORTA SYSTEM p. 188
- MINIMAX p. 186
- STEEL door frames p. 198-203

Recommended non-rebated door frames:

- PORTA SYSTEM ELEGANCE p. 190
- PORTA SYSTEM ELEGANCE 90 degrees p. 190

NOTES

- Norm PN EN 14351-2:2018-12.
- Magnetic lock is not available for a double door.
- Passive door leaf (panel) available in sizes: '30', '40', '50' - without a decorative milling
- Passive leaf sizes: from '60' to '100' Models J, K, L are not available as passive door leaves.
- There are two door leaves for non-rebated double leaf set: active and passive. Sizes: 60-100.
- Model E comes with horizontal wood graining, other models with vertical.
- PRIME hinges or 3D hinges – packed with the door frame.

EXTRA CHARGES

size '100'
finishing with Natural Veneer: Oak Satin White
door leaf height 220 cm
hollow chipboard core
ventilation undercut
black lock and black barrel hinges
magnetic lock with stainless steel faceplate
magnetic lock: white, black (for non-rebated doors)
magnetic lock: black and black barrel hinges (for rebated doors)
magnetic lock: gold
non-rebated door leaves: third 3D hinge, silver, white, black (extra charge to the door frame price)
non-rebated doors: third 3D hinge, gold (extra charge added to door frame price)
non-rebated door leaves: 3D hinges, gold (extra charge added to door frame price)
sliding door leaves - oblong pull handle
sliding door leaves - hook lock with side pull handles
reinforcement for a door closer requires third hinge
handle with an escutcheon

(p. 212)

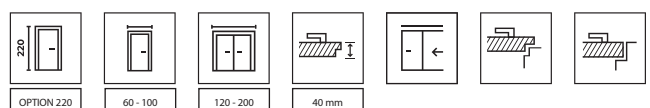



Nature LINE E2, Nero, ELEGANT silver handle



NATURAL VENEER FINISH



EVERY DETAIL MATTERS



ECOLOGICAL WATER VARNISHES



model F.1



model A.1



model B.1

NEW



model C.2

NEW



model E.2



ELEGANT door handle



model G.1



model H.1



model I.1



model L.1

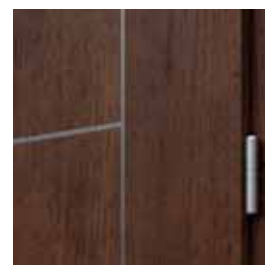

silver decorative inlay, PRIME hinge.
NEW: inlays are available also in black and golden colour.

NATURE LINE - AVAILABLE FINISHES

Natural Oak Satin Veneer ♥♥♥♥♥



Natural Veneer - Select ♥♥♥♥♥

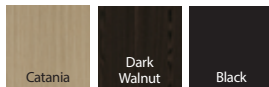

Natural Veneer - Oak ♥♥♥♥♥



Due to the characteristic of natural veneers, differences in colour and graining, might appear on a door leaf. These differences cannot be grounds for complaints.

K Give free rein to your imagination! Do you have your own door concept? You can order any milling with PORTA CONTRACT.

TECHNICAL INFORMATION

DOOR LEAF CONSTRUCTION

Core - stabilising infill reinforced with rails and stiles. Hollow chipboard core available at an extra charge. Preparation for shortening maximum 60 mm. Height '220': core - hollow chipboard; 3 hinges as a standard. The 3rd hinge is required for the 'reinforcement for door closer' option.

FINISH

The construction is skinned with a slim particle board which is finished with high quality Natural Veneer. The door leaf surface is protected by ecological water-based varnishes. Door leaves are enriched with aluminium decorative inlays (silver, golden or black), 6 mm wide.

ACCESSORIES

- rebated doors: three standard barrel hinges, or PRIME hinges
- Non-rebated doors and reversed rebated doors: two 3D hinges
- lock: key lock, WC lock, or cylinder lock
- oblong pull handle for sliding doors

DOOR FRAMES

Recommended rebated door frames:

- PORTA SYSTEM p. 188
- MINIMAX p. 186
- STEEL door frames p. 198-203

Recommended non-rebated door frames:

- PORTA SYSTEM ELEGANCE p. 190
- PORTA SYSTEM ELEGANCE 90 degrees p. 190

Recommended door frames with reversed rebate:

- PORTA SYSTEM with reversed rebate p. 192

NOTES

- Norm PN EN 14351-2:2018-12.
- Double doors are available in any door leaf size combinations
- Magnetic lock is not available for a double door.
- Passive door leaf is available for sizes from '60' to '100'.
- There are two door leaves for non-rebated double leaf set: active and passive. Sizes: 60-100.
- PRIME hinges or 3D hinges – packed with the door frame.

EXTRA CHARGES

- size '100'
- door leaf height 220 cm
- hollow chipboard core
- finishing with Natural Veneer: Oak Satin White
- finishing with Natural Veneer: Select Black
- ventilation undercut
- black lock and black barrel hinges
- magnetic lock with stainless steel faceplate
- magnetic lock: white, black (for non-rebated doors)
- magnetic lock: black and black barrel hinges (for rebated doors)
- magnetic lock: gold
- non-rebated door leaves: third 3D hinge, silver, white, black (extra charge to the door frame price)
- non-rebated doors: third 3D hinge, gold (extra charge added to door frame price)
- non-rebated door leaves: 3D hinges, gold (extra charge added to door frame price)
- reversed rebate - extra charge added to door leaf price
- reversed rebate - third 3D hinge, white, black (extra charge added to door frame price)
- reversed rebate - third 3D hinge, silver (extra charge added to door frame price)
- reversed rebate - 3D gold hinges (extra charge added to door frame price)
- reversed rebate - third 3D hinge, gold (extra charge added to door frame price)
- sliding door leaves - oblong pull handle
- sliding door leaves - hook lock with side pull handles
- reinforcement for a door closer requires third hinge
- handle with an escutcheon

(p. 212)

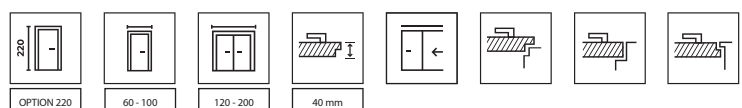



Nature LOFT 1.1, Oak 1, 'striped' wood grain, handle CUBE black



NATURAL VENEER FINISH



EVERY DETAIL MATTERS



ECOLOGICAL WATER VARNISHES



1.1, Oak 1 - 'flower' wood grain



1.1, Oak 1 - 'striped' wood grain



model 1.1, Ash



model 1.1, Walnut



ELEGANT door handle



3D hinges in the colour of the door frame

AVAILABLE FINISHES

Natural Veneer ♥♥♥♥◇◇

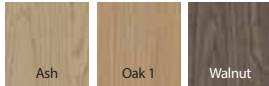

Veneers are available in 'flower' wood grain. Oak 1 Veneer is also available in striped wood grain.

Due to the characteristic of natural veneers, differences in colour and graining, might appear on a door leaf. These differences cannot be grounds for complaints.

AVAILABLE FINISHES OF DOOR FRAMES

Natural Veneer - Select ♥♥♥♥◇◇



TECHNICAL INFORMATION

DOOR LEAF CONSTRUCTION

Honeycomb or hollow chipboard core reinforced with rails and stiles (optionally at extra charge). Hollow chipboard core and chipboard core have preparation for shortening as a standard. - Size '100' requires third hinge.

FINISH

The construction is skinned with a particle board finished with Natural Veneer. Edges are taped with Select Natural Veneer - black. The distinctive features of this collection are black lipping on the side edges and black accessories.

ACCESSORIES

- two 3D hinges - Black
- magnetic lock in ABS tape colour - Black

DOOR FRAME

- PORTA SYSTEM ELEGANCE, black see p. 190
- PORTA SYSTEM ELEGANCE 90 degrees, black see p. 190

NOTES

- Norm PN EN 14351-2:2018-12.
- 3D hinges - packed with a door frame

EXTRA CHARGES

- size '100'
- hollow chipboard core
- ventilation undercut
- third 3D hinge (extra charge added to a door frame price)
- handle with an escutcheon

(p. 212)

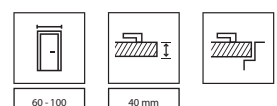



Nature OSLO 2, Oak 1, BELLA SLIM handle, black



NATURAL VENEER
FINISH



EVERY DETAIL
MATTERS



ECOLOGICAL
WATER VARNISHES



model 1



model 2



model 3

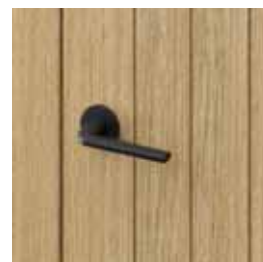

BELLA SLIM handle



model 1



model 2



model 3



decorative milling close up - visible
texture of natural oak

AVAILABLE FINISHES

Natural Oak Satin Veneer ♥♥♥♥♥



Natural Veneer ♥♥♥♥♥



Due to the characteristic of natural veneers, differences in colour and graining, might appear on a door leaf. These differences cannot be grounds for complaints.

TECHNICAL INFORMATION

DOOR LEAF CONSTRUCTION

Core - stabilising infi II reinforced with rails and stiles. Hollow chipboard core available at an extra charge. Preparation for shortening maximum 60 mm. Height '220': core - hollow chipboard; 3 hinges as a standard. Reinforcement for a door closer and size '100' require third hinge.

FINISH

The construction is skinned with a slim particle board which is finished with high quality Natural Veneer. The door leaf surface is protected by ecological water-based varnishes.

ACCESSORIES

- rebated doors: two or three barrel hinges standard or PRIME.
- non-rebated doors and reversed rebated doors: two 3D hinges
- lock: key lock, WC lock, or cylinder lock
- oblong pull handle for sliding doors

DOOR FRAMES

Recommended rebated door frames:

- PORTA SYSTEM p. 188
- MINIMAX p. 186

Recommended non-rebated door frames:

- PORTA SYSTEM ELEGANCE p. 190
- PORTA SYSTEM ELEGANCE 90 degrees p. 190

Recommended door frames with reversed rebate:

- PORTA SYSTEM with reversed rebate p. 192

NOTES

- Norm PN EN 14351-2:2018-12.
- Double doors are available in any door leaf size combinations.
- Magnetic lock is not available for a double door.
- Passive door leaf is available for sizes from '60' to '100'.
- There are two door leaves for non-rebated double leaf set: active and passive. Sizes: 60-100.
- PRIME hinges or 3D hinges – packed with the door frame.

EXTRA CHARGES

- size '100'
- door leaf height 220 cm
- hollow chipboard core
- ventilation undercut
- black lock and black barrel hinges
- magnetic lock with stainless steel faceplate
- magnetic lock: white, black (for non-rebated doors)
- magnetic lock: black and black barrel hinges (for rebated doors)
- magnetic lock: gold
- non-rebated door leaves: third 3D hinge, silver, white, black (extra charge to the door frame price)
- non-rebated doors: third 3D hinge, gold (extra charge added to door frame price)
- non-rebated door leaves: 3D hinges, gold (extra charge added to door frame price)
- reversed rebate - extra charge added to door leaf price
- reversed rebate - third 3D hinge, white, black (extra charge added to door frame price)
- reversed rebate - third 3D hinge, silver (extra charge added to door frame price)
- reversed rebate - 3D gold hinges (extra charge added to door frame price)
- reversed rebate - third 3D hinge, gold (extra charge added to door frame price)
- sliding door leaves - oblong pull handle
- sliding door leaves - hook lock with side pull handles
- reinforcement for a door closer requires third hinge
- handle with an escutcheon

(p. 212)

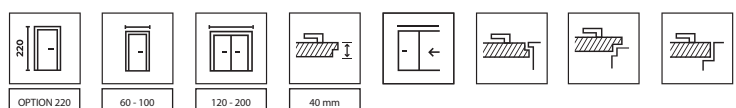



Nature GRANDE B.3, Black, handle OFFICE gold



NATURAL VENEER
FINISH



ECOLOGICAL
WATER VARNISHES



model A.0



model A.1



OFFICE handle, gold



model B.0



model B.1



model B.3



a door with glazing



model C.0



model C.1



model D.0



model D.1



flat panel

AVAILABLE FINISHES

Natural Oak Satin Veneer ◆◆◆◆◆◇◇

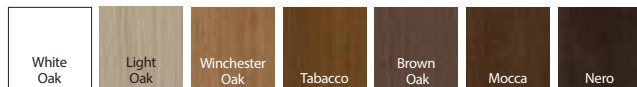

Natural Veneer - Select ◆◆◆◆◆◇◇

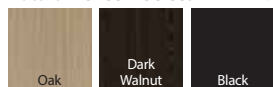

Natural Veneer ◆◆◆◆◆◇◇



Due to the characteristic of natural veneers, differences in colour and graining, might appear on a door leaf. These differences cannot be grounds for complaints.

TECHNICAL INFORMATION

DOOR LEAF CONSTRUCTION

Frame and panel construction. Door leaves contain stiles and frosted, tempered glass. Preparation for shortening maximum 60 mm. Size '100' requires third hinge.

FINISH

A door leaf is finished with Natural Veneer. Surface is protected by ecological water-based varnishes. Select, Natural Oak and Satin (apart from white) veneers are hardened under UV lamp (semi-matt).

ACCESSORIES

- rebated doors: three standard barrel hinges, or PRIME hinges
- non-rebated doors and reversed rebated doors: two 3D hinges
- lock: key lock, WC lock, or cylinder lock
- oblong pull handle for sliding doors

DOOR FRAMES

Recommended rebated door frames:

- PORTA SYSTEM p. 188
- MINIMAX p. 186

Recommended non-rebated door frames:

- PORTA SYSTEM ELEGANCE p. 190
- PORTA SYSTEM ELEGANCE 90 degrees p. 190

Recommended door frames with reversed rebate:

- PORTA SYSTEM with reversed rebate p. 192

NOTES

- Norm PN EN 14351-2:2018-12.
- Double doors are available in any door leaf size combinations
- Magnetic lock is not available for a double door.
- Passive door leaf is available for sizes from '60' to '100'.
- There are two door leaves for non-rebated double leaf set: active and passive. Sizes: 60-100.
- PRIME hinges or 3D hinges – packed with the door frame.

EXTRA CHARGES

- size '100'
- finishing with Natural Veneer: Oak Satin White
- finishing with Natural Veneer: Select Black
- ventilation undercut
- black lock and black barrel hinges
- magnetic lock with stainless steel faceplate
- magnetic lock: white, black (for non-rebated doors)
- magnetic lock: black and black barrel hinges (for rebated doors)
- magnetic lock: gold
- non-rebated door leaves: third 3D hinge, silver, white, black (extra charge to the door frame price)
- non-rebated doors: third 3D hinge, gold (extra charge added to door frame price)
- non-rebated door leaves: 3D hinges, gold (extra charge added to door frame price)
- reversed rebate - extra charge added to door leaf price
- reversed rebate - third 3D hinge, white, black (extra charge added to door frame price)
- reversed rebate - third 3D hinge, silver (extra charge added to door frame price)
- reversed rebate - 3D gold hinges (extra charge added to door frame price)
- reversed rebate - third 3D hinge, gold (extra charge added to door frame price)
- sliding door leaves - oblong pull handle
- sliding door leaves - hook lock with side pull handles
- handle with an escutcheon

(p. 212)

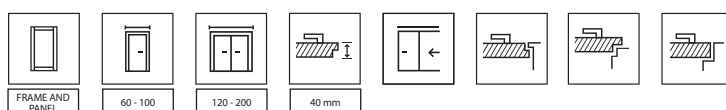



Nature SPACE G.1 with black glazing, Brown Oak, handle DIVO FIT Q black



NATURAL VENEER FINISH



ECOLOGICAL WATER VARNISHES



model F.1



model G.1
black glazing also available



model H.1



DIVO FIT Q handle



door with black glazing



door with frosted glazing

AVAILABLE FINISHES

Natural Oak Satin Veneer ♥♥♥♥♥◇◇

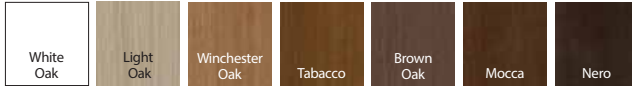

Natural Veneer - Select ♥♥♥♥♥◇◇



Natural Veneer ♥♥♥♥♥◇◇



Due to the characteristic of natural veneers, differences in colour and graining, might appear on a door leaf. These differences cannot be grounds for complaints.

TECHNICAL INFORMATION

DOOR LEAF CONSTRUCTION

Glued softwood. Core - hollow chipboard. Door leaves contain rails and stiles finished with Natural Veneer. Thanks to applied technology, door leaf is very resistant to deformation.

FINISH

Surface is protected by ecological water-based varnishes. Select, Natural Oak and Satin (apart from white) veneers are hardened under UV lamp (semi-matt). Glass in glazed models is 8 mm thick, frosted. Model G.1 is available with black, laminated safety glass (optionally at extra charge).

ACCESSORIES

- rebated doors: three standard barrel hinges, or PRIME hinges
- non-rebated doors: two 3D hinges
- lock: key lock, WC lock, or cylinder lock

DOOR FRAMES

Recommended rebated door frames:

- PORTA SYSTEM p. 188
- MINIMAX p. 186
- STEEL door frames see p. 198-203

Recommended non-rebated door frames:

- PORTA SYSTEM ELEGANCE p. 190
- PORTA SYSTEM ELEGANCE 90 degrees p. 190

NOTES

- Norm PN EN 14351-2:2018-12.
- Ventilation sleeves - silver or gold. 1 row (model F.1, G.1).
- Double doors are available in any door leaf size combinations
- Magnetic lock is not available for a double door.
- Passive door leaf is available for sizes from '60' to '100'.
- There are two door leaves for non-rebated double leaf set: active and passive. Sizes: 60-100.
- PRIME hinges or 3D hinges – packed with the door frame.

EXTRA CHARGES

- size '100'
- finishing with Natural Veneer: Oak Satin White
- ventilation sleeves (model F.1, G.1)
- black glass panel - model G.1
- black lock and black barrel hinges
- magnetic lock with stainless steel faceplate
- magnetic lock: white, black (for non-rebated doors)
- magnetic lock: black and black barrel hinges (for rebated doors)
- magnetic lock: gold
- non-rebated door leaves: third 3D hinge, silver, white, black (extra charge to the door frame price)
- non-rebated doors: third 3D hinge, gold (extra charge added to door frame price)
- non-rebated door leaves: 3D hinges, gold (extra charge added to door frame price)
- sliding door leaves - oblong pull handle
- sliding door leaves - hook lock with side pull handles
- handle with an escutcheon

(p. 212)

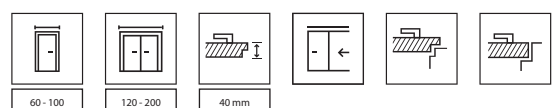



Nature CONCEPT C.6, Oak, handle OFFICE silver



NATURAL VENEER
FINISH



ECOLOGICAL
WATER VARNISHES



model A.0



model A.3



model A.9



NEXT handle



model C.0



model C.2



model C.4



model C.6



frosted glass panel – model A.9



model K.0



model K.1



model K.2



model K.3

AVAILABLE FINISHES

Natural Oak Satin Veneer ◆◆◆◆◆◇◇

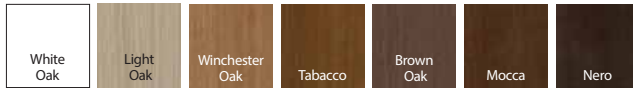

Natural Veneer - Select ◆◆◆◆◆◇◇



Natural Veneer ◆◆◆◆◆◇◇



Due to the characteristic of natural veneers, differences in colour and graining, might appear on a door leaf. These differences cannot be grounds for complaints.

TECHNICAL INFORMATION

DOOR LEAF CONSTRUCTION

Glued laminated softwood with MDF. Thanks to applied technology, door leaf is very resistant to deformations. Preparation for shortening (maximum 60 mm).

FINISH

A door leaf is finished with Natural Veneer. Surface is protected by ecological water-based varnishes. Select, Natural Oak and Satin (apart from white) veneers are hardened under UV lamp (semi-matt). Tempered frosted glass.

ACCESSORIES

- rebated doors: three standard barrel hinges, or PRIME hinges
- non-rebated doors: two 3D hinges
- lock: key lock, WC lock, or cylinder lock
- oblong pull handle for sliding doors

DOOR FRAMES

Recommended rebated door frames:

- PORTA SYSTEM p. 188
- MINIMAX p. 186

Recommended non-rebated door frames:

- PORTA SYSTEM ELEGANCE p. 190
- PORTA SYSTEM ELEGANCE 90 degrees p. 190

NOTES

- Norm PN EN 14351-2:2018-12.
- Ventilation sleeves - silver or gold. 1 row
- Double doors are available in any door leaf size combinations
- Magnetic lock is not available for a double door.
- Passive door leaf is available for sizes from '60' to '100'.
- There are two door leaves for non-rebated double leaf set: active and passive.
- Sizes: 60-100.
- PRIME hinges or 3D hinges – packed with the door frame.

EXTRA CHARGES

size '100'
finishing with Natural Veneer: Oak Satin White
undercut, ventilation sleeves
black lock and black barrel hinges
magnetic lock with stainless steel faceplate
magnetic lock: white, black (for non-rebated doors)
magnetic lock: black and black barrel hinges (for rebated doors)
magnetic lock: gold
non-rebated door leaves: third 3D hinge, silver, white, black (extra charge to the door frame price)
non-rebated doors: third 3D hinge, gold (extra charge added to door frame price)
non-rebated door leaves: 3D hinges, gold (extra charge added to door frame price)
sliding door leaves - oblong pull handle
sliding door leaves - hook lock with side pull handles
handle with an escutcheon

(p. 212)

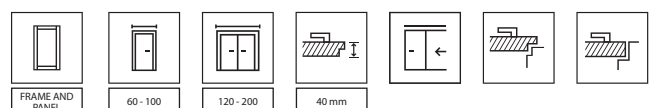



SEVILLA solid, White Oak, handle AZALIA black



NATURAL VENEER
FINISH



EVERY DETAIL
MATTERS



ECOLOGICAL
WATER VARNISHES



solid



glazed model



side panel I



side panel J



AZALIA handle



raised panel profile

AVAILABLE FINISHES

Natural Oak Satin Veneer ♥♥♥♥♥◇◇

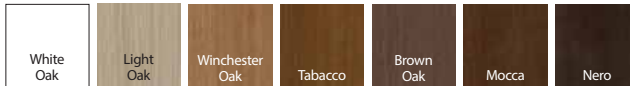

Natural Veneer ♥♥♥♥♥◇◇



also available in unvarnished option

Due to the characteristic of natural veneers, differences in colour and graining, might appear on a door leaf. These differences cannot be grounds for complaints.

TECHNICAL INFORMATION

DOOR LEAF CONSTRUCTION

Glued laminated softwood with MDF. Thanks to applied technology, door leaf is very resistant to deformations. Preparation for shortening maximum 60 mm. A door leaf with a ventilation slit - shortening up to 40 mm.

FINISH

A door leaf is finished with Natural Veneer. Surface is protected by ecological water-based varnishes. Natural Oak and Satin (apart from white) veneers are hardened under UV lamp (semi-matt). Unvarnished door leaves are available in a standard product price. 'Chinchilla' or frosted tempered glass. There is a possibility of producing with mirror just one side (there is a board on the other side).

ACCESSORIES

- rebated doors: three standard barrel hinges, or PRIME hinges
- non-rebated doors: two 3D hinges
- lock: key lock, WC lock, or cylinder lock
- oblong pull handle for sliding doors
- a seal fitting the glass panel

DOOR FRAMES

Recommended rebated door frames:

- PORTA SYSTEM p. 188
- MINIMAX p. 186

Recommended non-rebated door frames:

- PORTA SYSTEM ELEGANCE p. 190
- PORTA SYSTEM ELEGANCE 90 degrees p. 190

NOTES

- Norm PN EN 14351-2:2018-12.
- Ventilation sleeves - silver or gold. 1 row
- Double doors are available in any door leaf size combinations
- Magnetic lock is not available for a double door.
- Passive door leaf available in sizes '60' up to '100' or in size '40' (side panel).
- There are two door leaves for non-rebated double leaf set: active and passive. Sizes: 60-100.
- PRIME hinges or 3D hinges – packed with the door frame.

EXTRA CHARGES

- size '100'
- finishing with Natural Veneer: Oak Satin White
- ventilation undercut, slit or sleeves
- mirror on one side
- black lock and black barrel hinges
- magnetic lock with stainless steel faceplate
- magnetic lock: white, black (for non-rebated doors)
- magnetic lock: black and black barrel hinges (for rebated doors)
- magnetic lock: gold
- K an astragal for double-leaf doors
- non-rebated door leaves: third 3D hinge, silver, white, black (extra charge to the door frame price)
- non-rebated doors: third 3D hinge, gold (extra charge added to door frame price)
- non-rebated door leaves: 3D hinges, gold (extra charge added to door frame price)
- sliding door leaves - oblong pull handle
- sliding door leaves - hook lock with side pull handles
- handle with an escutcheon

(p. 212)

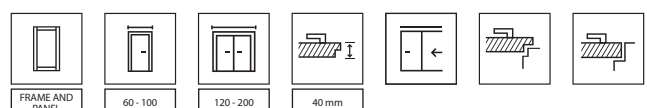



CORDOBA large muntin, K side panel, Tabacco, MODERN handle, silver



NATURAL VENEER FINISH



EVERY DETAIL MATTERS



ECOLOGICAL WATER VARNISHES



CORDOBA solid



CORDOBA small glazing



CORDOBA muntin



CORDOBA large muntin



ACCENT PLUS handle



MADRID solid



MADRID small glazing



MADRID muntin



MADRID large muntin



CORDOBA minimalist rails and stiles chamfered with 20°



side panel A side panel K



MADRID decorative profiled stile and decorative covered pan

AVAILABLE FINISHES

Natural Oak Satin Veneer ♥♥♥♥♥◇◇

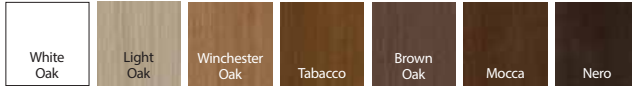

Natural Veneer ♥♥♥♥♥◇◇



also available in unvarnished option

Due to the characteristic of natural veneers, differences in colour and graining, might appear on a door leaf. These differences cannot be grounds for complaints.

TECHNICAL INFORMATION

DOOR LEAF CONSTRUCTION

Glued laminated softwood with MDF. Thanks to applied technology, door leaf is very resistant to deformations. Rails and stiles of Cordoba are chamfered with 20°. Preparation for shortening maximum 60 mm. A door leaf with a ventilation slit - shortening up to 40 mm.

FINISH

A door leaf is finished with Natural Veneer. Surface is protected by ecological water-based varnishes. Natural Oak and Satin (apart from white) veneers are hardened under UV lamp (semi-matt). Unvarnished door leaves are available in a standard product price. 'Chinchilla' or frosted tempered glass.

ACCESSORIES

- rebated doors: three standard barrel hinges, or PRIME hinges
- non-rebated doors: two 3D hinges
- lock: key lock, WC lock, or cylinder lock
- oblong pull handle for sliding doors
- a seal fitting the glass panel

DOOR FRAMES

Recommended rebated door frames:

- PORTA SYSTEM p. 188
- MINIMAX p. 186

Recommended non-rebated door frames:

- PORTA SYSTEM ELEGANCE p. 190
- PORTA SYSTEM ELEGANCE 90 degrees p. 190

NOTES

- Norm PN EN 14351-2:2018-12.
- Ventilation sleeves - silver or gold. 1 row
- Double doors are available in any door leaf size combinations
- Magnetic lock is not available for a double door.
- Passive door leaf available in sizes '60' up to '100' or in size '40' (side panel).
- There are two door leaves for non-rebated double leaf set: active and passive. Sizes: 60-100.
- PRIME hinges or 3D hinges – packed with the door frame.

EXTRA CHARGES

size '100'

finishing with Natural Veneer: Oak Satin White
 ventilation undercut, slit or sleeves
 black lock and black barrel hinges
 magnetic lock with stainless steel faceplate
 magnetic lock: white, black (for non-rebated doors)
 magnetic lock: black and black barrel hinges (for rebated doors)
 magnetic lock: gold

[X] an astragal for double-leaf doors
 non-rebated door leaves: third 3D hinge, silver, white, black (extra charge to the door frame price)

non-rebated doors: third 3D hinge, gold (extra charge added to door frame price)

non-rebated door leaves: 3D hinges, gold (extra charge added to door frame price)

sliding door leaves - oblong pull handle

sliding door leaves - hook lock with side pull handles

handle with an escutcheon

(p. 212)

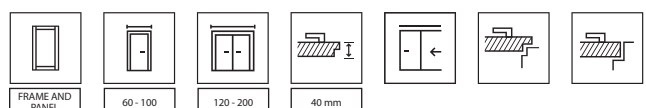



Villadora RETRO, Residence 0, RETRO Module, White Oak, white LUNGO handle



NATURAL VENEER FINISH



EVERY DETAIL MATTERS



ECOLOGICAL WATER VARNISHES



Capital 0



Capital 1



Residence 0



Residence 2



LUNGO handle



Delarte 0



Delarte 1



Delarte 2



Delarte 3



decorative moulding with a raised panel



Empire 0



Empire 1

CROSS-SECTION OF VILLADORA RETRO DOOR FRAME



door frame profile - wide architrave 80 mm



the Retro Module (crown + decorative pilasters)

RETRO module (set)

=

Crown

+

decorative pilasters vertical (set)

AVAILABLE FINISHES

Natural Oak Satin Veneer ♥♥♥♥♥



Due to the characteristic of Natural veneers, differences in colour and graining, might appear on a door leaf. These differences cannot be grounds for complaints.

TECHNICAL INFORMATION

DOOR LEAF CONSTRUCTION

Frame and panel construction. Frame and panel construction. Rails and stiles made of high quality softwood and wood-based materials, finished with Natural Oak Veneer. Decorative mouldings/beads made of solid oak. Preparation for shortening (maximum 60 mm).

FINISH

Specially selected satin tempered glass. The door leaf surface is protected by ecological water-based varnishes.

ACCESSORIES

- lock with glossy faceplate (silver or gold): key lock, WC lock, or cylinder lock
- three pc. of adjustable barrel hinges (3D) - packed with a door frame. Option of purchasing caps for hinges in a few colours: glossy golden, old gold, glossy silver- see extra charges.

NOTES

- Norm PN EN 14351-2:2018-12.
- Double doors are available in any door leaf size combinations.
- Magnetic lock is not available for a double door.
- Passive door leaf is available for sizes from '60' to '100'.
- There are two door leaves for non-rebated double leaf set: active and passive. Sizes: 60-100.

EXTRA CHARGES

ventilation undercut, ventilation slit without extra charge
 ventilation sleeves 1 row
 magnetic lock with stainless steel faceplate
 handle with an escutcheon (p. 212)

DOOR FRAME CONSTRUCTION

The door frame consists of:

- A door frame head and two jambs, made of wood-based material. It comes with hardware and accessories.
 - band slats
- Villadora RETRO is produced and delivered as a set of elements to be assembled on site.

ACCESSORIES INCLUDED IN THE DOOR FRAME PRICE

- Three sets of adjustable barrel hinges (3D)
- A rubber seal set circumferentially

DOOR FRAME SIZE, SEE PAGE, 224, TABLE 1

Adjustment ranges (A-K): '60', '70', '80', '90', '100' and '120' ÷ '200'.

NOTES

- Technical Assessment ITB-KOT-2018/0358, issue 2
- Door frame should be installed on finished walls (e.g. wall papers) and on a finished floor (e.g. floor panels).



FOLDING AND SLIDING

→ We distinguish **two types of** sliding systems



POCKET SYSTEM DOORS
DOOR RETRACTS IN THE WALL
- SYSTEMS: COMPACT and FRAMELESS systems.



ON-WALL SYSTEM
DOORS SLIDE ALONG THE WALL
- SYSTEMS: PORTA, ALU, BLACK, SLIDE, EFEKT

→ Explore **advantages of** folding and sliding Porta doors

- ✓ Sliding systems are **compatible with all Porta** door leaf COLLECTIONS.
- ✓ They can be used, for example, between the kitchen and living room, thus **integrating the two rooms, or dividing them** - depending on your needs.
- ✓ They take up less space / **you will save space.**
- ✓ **They allow more freedom in terms of positioning furniture**, tall plants in pots or other decorative elements.

 **TIP!** Buy CONVENIENTLY
as a complete system + door
leaf + pull



ALFA folding doors



ALFA, BETA, Natural Oak



HOW TO OPEN THE DOOR* (top view)

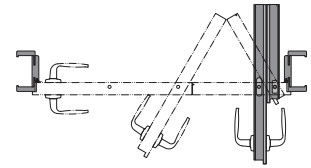

Right door

A REBATED DOOR LEAF

The complete set consists of:

- track system (extra charge to the system)
- two-part door leaf
- PORTA SYSTEM door frame (modified)

AVAILABLE FINISHES, colours samples see p. 234 – 241.



Portadecor
Standard Lacquer
Portasynchro



Portaperfect 3D



Matt Lacquered Veneer



CPL HQ 0.2 mm

TECHNICAL INFORMATION

DOOR LEAF CONSTRUCTION

Honeycomb core or hollow chipboard core reinforced with plywood rails and stiles (at extra charge).

Alfa – a two-part door, asymmetrically divided, with a standard lock in a door leaf and a tongue strike in a door frame.

ACCESSORIES

- seal
- three silver concealed hinges
- lock: key lock, WC lock, cylinder lock
- strike plate

DOOR FRAMES

- Modified PORTA SYSTEM, adjustment range from B to K see p. 188.

NOTES

- National - Technical Assessment ITB-KOT-2017/0184 issue 2
- Dimensions see Table 1, page 224.

EXTRA CHARGES

ALFA track (extra charge for the set)
size '100'

hollow chipboard core

door leaf: CPL 0,2mm - GROUP II

door frame: CPL 0,2mm - GROUP II

ventilation sleeves, ventilation undercut

handle with an escutcheon

(p. 213)

*NOTE: Due to fittings specifics there is a slight narrowing of clear opening width when the door is open. (about 10 cm).

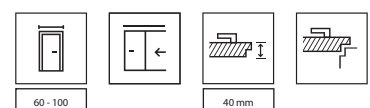

BETA folding doors



ALFA, BETA, White



HOW TO OPEN THE DOOR* (top view)

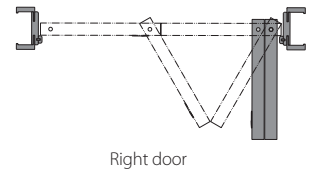

A NON-REBATED DOOR LEAF

- The complete set consists of:
- track system
 - two-part door leaf
 - PORTA SYSTEM door frame (modified)

AVAILABLE FINISHES, colours samples see p. 234 – 241.



Standard Paint
Portadecor
Portasynchro



Portaperfect 3D



Matt Lacquered Veneer



CPL HQ 0.2 mm

TECHNICAL INFORMATION

DOOR LEAF CONSTRUCTION

Honeycomb core or hollow chipboard core reinforced with plywood rails and stiles (at extra charge).

Beta – a two part door, symmetrically divided without a lock.

ACCESSORIES

- track
- seal
- three silver, concealed hinges
- round door pull

DOOR FRAMES

- Modified PORTA SYSTEM, adjustment range from B to K see p. 188.

NOTES

- National - Technical Assessment ITB-KOT-2017/0184 issue 2
- Dimensions see Table 1, page 224.

EXTRA CHARGES

BETA track included in the door frame price

without extra charge

hollow chipboard core

door leaf: CPL 0,2mm - GROUP II

door frame: CPL 0,2mm - GROUP II

ventilation sleeves, ventilation undercut

*NOTE: Due to fittings specifics there is a slight narrowing of clear opening width when the door is open. (about 10 cm).

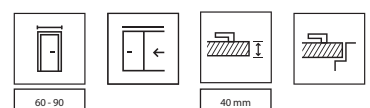

PORTA sliding system



Sliding system PORTA, PORTA CONCEPT, A.9, Grey



- The complete set consists of:**
- on wall-mounted sliding system
 - a door leaf (sliding version)
 - a door frame* (tunnel version)

AVAILABLE FINISHES, colours samples see p. 234 – 241.



Portadecor
Portasynchro 3D



Premium Lacquered Veneer
Portaperfect 3D
Natural Oak Satin, Natural Veneer
- Select
Natural Oak Veneer



Matt Lacquered Veneer



CPL HQ 0.2 mm
Gladstone / Halifax

TECHNICAL INFORMATION

CONSTRUCTION

On Wall Sliding system consists of: a rail bar with trolleys, rail cover & door stop. Rail cover and a door stop are made of chipboard and MDF. Natural veneers are finished with semi-matt varnish.

ACCESSORIES INCLUDED IN THE PRICE

- a rail with trolleys
- strike plate
- self- Adhesive brush seal
- guide element which stabilizes the door leaf. Floor-mounted.

DOOR FRAMES

- PORTA SYSTEM door frame in the "tunnel" version, page. 188.
- Dimensions see Table 6, p. 227.

NOTES

- National - Technical Assessment ITB-KOT-2017/0184 issue 2
- **Set is reversible (left/right). Opening direction can be changed by installing door stop (jamb) on right or left side of PORTA System tunnel.**

* not included in the price

EXTRA CHARGES

CPL finish 0,2 mm - GROUP II
finishing with Natural Veneer: White Oak, Satin
finishing with Natural Veneer: Oak Satin Black

ALU sliding system



Sliding system ALU, Porta decor, solid, white



The set consists of:

- on wall-mounted sliding system (track)
- a door leaf (sliding version)
- a door frame* (tunnel version)

AVAILABLE FINISHES OF TUNNEL colour samples see p. 234 – 241.



Portadecor
Portasynchro 3D



Premium Lacquered Veneer
Portaperfect 3D
Natural Oak Satin, Natural Veneer
- Select
Natural Oak Veneer



Matt Lacquered Veneer



CPL HQ 0.2 mm
Gladstone / Halifax

TECHNICAL INFORMATION

CONSTRUCTION OF ALU SLIDING SYSTEM

Offered system consists of: a rail and a construction profile supporting the door leaf. Both elements are made of nicely looking aluminium.

ACCESSORIES INCLUDED IN THE PRICE

Guide element which stabilizes the door leaf. Floor-mounted.

DOOR FRAMES

PORTA SYSTEM frame 'tunnel', see p. 188
- dimensions see Table 6, page. 227.

NOTES

- Set is reversible (left/right).
- In order to assemble the track system, a door leaf and a tunnel door frame correctly, door leaf must be one size bigger. E.g track system and tunnel size '70' goes with door leaf '80', track system and tunnel '80' goes with a door leaf '90', '150' --> 2x '80', '170' --> 2x '90' etc
- Hook lock is not available.

* not included in the price

EXTRA CHARGES TO THE TUNNEL

CPL 0,2 mm Veneer GROUP II
finishing with Natural Veneer: White Oak, Satin
finishing with Natural Veneer: Oak Satin Black

COMPACT sliding system



Sliding system COMPACT, Porta CONCEPT A.9, Scandinavian Oak



hook lock



Metal cassette (pocket)

AVAILABLE FINISHES, colours samples see p. 234 – 241.



Portadecor
Portasynchro 3D



Premium Lacquered Veneer
Portaperfect 3D



Premium Plus UV Paint
Matt Lacquered Veneer



CPL HQ 0.2 mm
Gladstone / Halifax

HOW TO OPEN THE DOOR (top view)

Pocket door system COMPACT ('tunnel' frame, metal cassette (pocket) dedicated for a wall 125 mm thick)

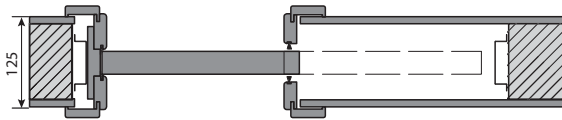

COMPACT 'tunnel' frames are dedicated for wall thicknesses 100 mm and 150 mm

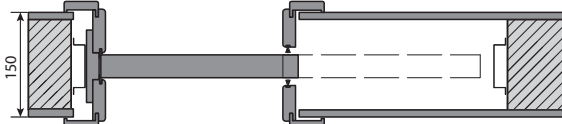
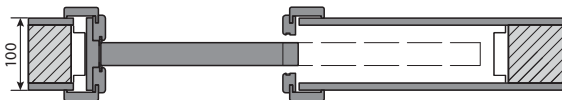

NOTE! Porta Compact tunnel frame is dedicated to work together with Porta pockets and pockets of leading European producers. Before installing Compact tunnel frame along with a pocket not produced by PORTA, it is required to check So/Ho dimensions.



Possibility of ordering 'tunnel' in Natural Veneer through Porta CONTRACT.

TECHNICAL INFORMATION

COMPACT SYSTEM CONSTRUCTION

Offered system for a 125 mm thick wall, consists of: a 'tunnel frame' made of chipboard and MDF; galvanized steel cassette with a running track, which is a pocket construction inside the wall.

ACCESSORIES INCLUDED IN THE SET PRICE

- pocket is dedicated for a wall - 125 mm thick
- rail with trolleys and a floor-mounted element which guides the door leaf
- hook lock strike (optionally, at an extra charge)
- anti-dust brush seal. Pressed in. (tunnels dedicated for a wall 125 mm and 150 mm thick).
- 'Tunnel' for a wall 125 mm thick

DOOR FRAMES

- Door frames - 'tunnel' option. Available for wall thicknesses: 100 mm, 125 mm and 150 mm
- 'Tunnel' door frame dedicated for a wall thickness 125 mm is compatible with the PORTA pocket.
- All of above mentioned 'tunnel frames' are compatible with pockets of leading European producers (H₀/S₀ dimensions must be checked)
- COMPACT, dimensions see Table 6, page. 227.

NOTES

- Pocket system is dedicated for 125 mm thick plasterboard walls.
- It is possible to order additional extensions for symmetrical and unsymmetrical tunnel frames' (bespoke order).
- Tunnel 100 mm is available with door leaves without glazing beads/decorative mouldings.

EXTRA CHARGES

CPL finish 0,2 mm - GROUP II
closing synchronization system - double doors

FRAMELESS sliding system



FRAMELESS sliding system, Premium Paint



door leaf with hook lock



dedicated pull handles (round or square)

AVAILABLE FINISHES as on page 29

HOW TO OPEN THE DOOR (top view)

The system does not require a door frame and architraves.
The cassette (pocket) is dedicated to be installed in plasterboard walls.

Sliding system dedicated for a wall 100 mm thick.



Sliding system dedicated for a wall 125 mm thick.

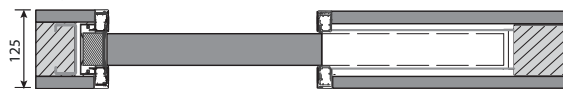

TECHNICAL INFORMATION

FRAMELESS SYSTEM CONSTRUCTION

The sliding system is made of aluminium profiles adapted for installation in plasterboard or solid brick walls. Can be used with 40 mm thick door leaves.

The system includes complete accessories and features enabling precise installation of the system adjustment of the leaf (adjustment of the depth of the leaf hiding in the system, adjustment of the leaf position in relation to the frame - at the height +/- 2,5 mm) and a removable door stop enables replacing the leaf, a set of gaskets, guides, bearing rollers.

ACCESSORIES INCLUDED IN THE PRICE

- metal cassette (pocket)
- hook lock strike (optionally, at an extra charge)

DOOR LEAF CONSTRUCTION

Plasterboard or hollow chipboard core (optionally at extra charge). The construction is skinned with HDF.

NOTES

- Norm PN EN 14351-2:2018-12 - door leaf.
- National - Technical Assessment ITB-KOT-2020/1281 issue.1 - sliding system.
- System prepared for plasterboard walls with a thickness of 100 mm or 125 mm.
- Dimensions see Table 6, p. 227.

EXTRA CHARGES

hollow chipboard core
hook lock with door pulls
round or square door pull
CPL finish 0,2 mm - GROUP II
to Natural Select Veneer for Natural Veneer Ash, Oak 1, Matt Oak
to Natural Select Veneer for Natural Veneer Walnut

Sliding system BLACK



Sliding system BLACK, type REA



REA type



LUNA type



pull Black 1



model 1

model 2

model 3

model 4

model 5

AVAILABLE FINISHES

Premium UV Paint ♥♥♥♥♥◇



White

Premium Plus UV Paint ♥♥♥♥♥◇



White

TECHNICAL INFORMATION

DOOR LEAF CONSTRUCTION

Honeycomb or hollow chipboard core (optionally at extra charge). The construction is skinned with HDF.

ACCESSORIES INCLUDED IN THE SET PRICE

- track 2000 mm

NOTES

- Norm PN EN 14351-2:2018-12.
- Set is reversible (left/right).
- Set is dedicated to be mounted on wall opening one size smaller than standard. See details see p. 228.
- Hook lock is not available
- For a double door leaf set the following parts must be ordered: two sliding systems, two door leaves and a bracket.
- In case of using spacers there is a possibility to move the door leaf away from the wall - 10 mm. Possibility of having BLACK system with other sliding door leaf from PORTA's offer
- Black system, type LUNA can be ordered with any door leaf in sliding version.
- Black system, type REA can be applied only with door leaves with hollow chipboard core.

EXTRA CHARGES

- hollow chipboard core
- black pull for one side
- an oblong pull for sliding door
- bracket for double door solutions
- set of two soft-closers
- set of 5 spacers

SLIDE



EFEKT



AVAILABLE FINISHES OF SLIDE System

Portaperfect 3D Veneer ♥♥♥♥♥◇◇

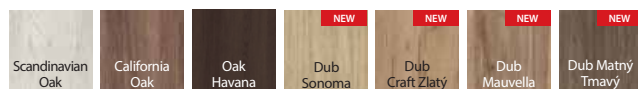

Gladstone / Halifax ♥♥♥♥♥♥♥

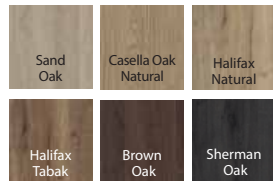

AVAILABLE FINISHES OF EFEKT System

Portaperfect 3D Veneer ♥♥♥♥♥◇◇

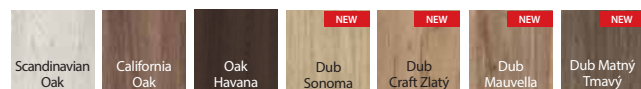

Gladstone / Halifax ♥♥♥♥♥♥♥

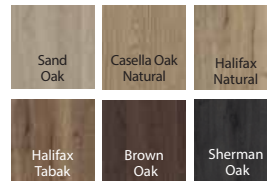

Premium Paint ♥♥♥♥♥◇◇



Matt Lacquered Veneer ♥♥♥♥♥♥◇



TECHNICAL INFORMATION

SLIDE System

DOOR LEAF CONSTRUCTION

Hollow chipboard core. The construction is skinned with HDF.

ACCESSORIES INCLUDED IN THE SET PRICE

- track 2000 mm
- set of two soft-closers

NOTES

- Norm PN EN 14351-2:2018-12.
- Set is dedicated to be mounted on wall opening one size smaller than standard. See details see table 6, p. 228.
- Hook lock is not available

EXTRA CHARGES

an oblong pull for sliding door

EFEKT System

DOOR LEAF CONSTRUCTION

Hollow chipboard core. The construction is skinned with HDF.

ACCESSORIES INCLUDED IN THE PRICE

- track

NOTES

- Norm PN EN 14351-2:2018-12.
- Hook lock is not available
- Load capacity of the system: 80 kg.
- the gap between door leaf and a wall: 10 mm. During installation, this dimension can be increased by using a spacer for top trolley (spacer is not a part of the set). The second option is to order a door leaf fitted to needed gap size (Contract Department).
- The set is dedicated to be mounted on wall opening three sizes smaller than standard -> E.g. wall opening '60' requires door leaf '90'
- Dimensions see Table 6, p. 228.

EXTRA CHARGES

size '100' and '110'
an oblong pull for sliding door

TECHNICAL

09,10

AND ENTRANCE DOORS

→ SUMMARY OF AVAILABLE MODELS



SOLID –crossed graining of Natural Veneer*



SOLID - vertical graining of natural, synthetic Veneer and Gladstone/ Halifax



SOLID - horizontal graining of Natural Veneer and Gladstone/ Halifax.



decorative inlays 1



decorative inlays 3



decorative inlays 4



decorative inlays 6



decorative inlays 7



decorative inlays 8



decorative inlays 9

PRESENTED COLLECTIONS OF MODELS APPLY AS:



TECHNICAL DOORS

Acoustic 27 dB, 32 dB, INNOVO 37 dB, PORTA SILENCE 37 dB, EI 30, INNOVO 42 dB, 42 dB, Fire-rated EI 30, EI 60



APARTMENT ENTRANCE DOORS (NOTE THE RC* MARKING ON COLLECTIONS)

AGATE, OPAL, EXTREME RC 2, QUARTZ, EXTREME RC 3, EXTREME RC 4, GRANITE cl. C



(RC 2) class - resistance class to provide basic protection against break-in attempts with use of simple tools e.g. a screwdriver, a wedge, pincers, a hammer.

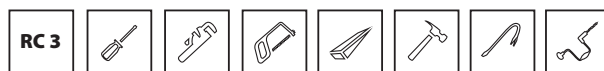

(RC 3) class - resistance class to provide protection against break-in attempts with use of tools e.g. a crowbar, a cotter pin driver, a mechanical drill.

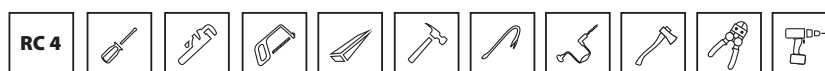

(RC 4) class - resistance class to provide protection against break-in attempts with use of tools e.g. an axe, wire cutter a mechanical drill.

RC-resistance class it's the ability of certain product to withstand violent intrusion in protected rooms or areas.

NOTE! Models with decorative inlays:

- synthetic veneers - vertical graining,
- Gladstone/Halifax finish models 3, 6, 9 - graining direction - according to decorative inlays orientation
- natural veneers - grain in line with the direction of the inlay.

*model only available in veneers: Natural Select, Natural Oak, Ash, Walnut



TIP! Shop CONVENIENTLY
as a set door + handle





Acoustic 32 dB, White



cylinder lock



3-part hinge

All available models - see p. 142

ACOUSTIC RATING OF THE DOORS:

- $R_w=27$ dB (27-31 dB)*
- $R_w=32$ dB (32-36 dB)*

* Detailed tests results are available at the manufacturer.

Acoustic 27 dB, 32 dB

AVAILABLE FINISHES

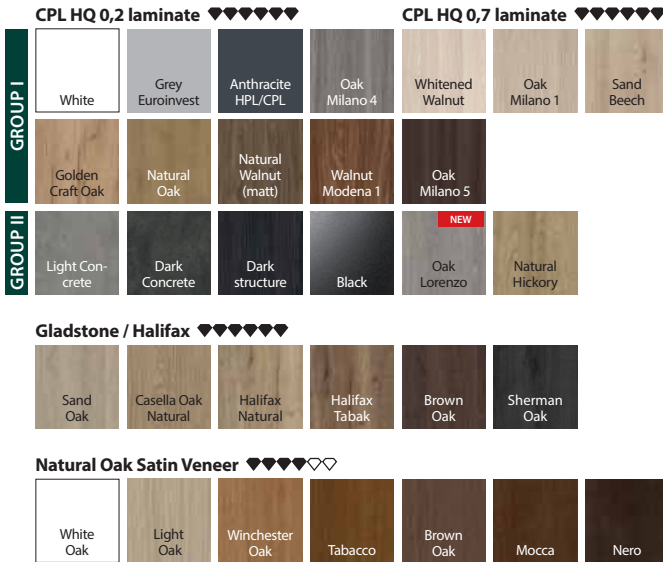

Natural Veneer - Select



Natural Veneer

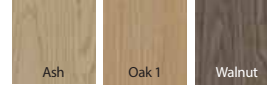

NOTE! Natural Veneer (excluding natural veneers: Ash and Walnut) are available with vertical and horizontal graining (applies to a door leaf).

TECHNICAL INFORMATION

ACCESSORIES

- three barrel hinges (adjustable door frame PORTA SYSTEM 27 dB) or three-part hinges (adjustable door frame PORTA SYSTEM 32 dB and steel door frame 27 dB, 32 dB).
- cylinder lock
- an automatic threshold seal
- a door frame seal
- door frame
- a door leaf finished with CPL HQ or Gladstone/Halifax has lipping ABS on the side edges

DOOR FRAMES

- PORTA SYSTEM adjustable door frame (27dB door)
- Reinforced PORTA SYSTEM adjustable door frame (32dB door)
- Corner steel door frame of 100mm wide profile
- PROJECT BIS, PROJECT PREMIUM door frame (204)

NOTES

- Technical Assessment ITB-KOT-2017/0096 issue 2 (Rw=27dB)
- Technical Assessment ITB-KOT-2017/0007 issue 2 (Rw=32dB)
- Acoustic insulation class Rw=27 dB (range 27÷31 dB) D₁=25 dB.
- Technical Assessment ITB-KOT-2017/0007 issue 1 (Rw=32dB)
- 32 dB door leaf is reinforced for a door closer.
- Size '60' available for flush doors only
- **Thanks so TechnoPORTA technology door leaves finished with synthetic veneers have lower edges protected against humidity.**

EXTRA CHARGES

- size '100'
- dowels or mounting anchors (steel door frame)
- adjustable lock strike in a steel door frame
- three-part hinges with Porta SYSTEM 27 dB door frame
- decorative inlays, for natural veneers (on one side, both sides price x2)
- decorative inlays, for synthetic Veneer (for one side, for both sides, price 2x)
- door frame: Polyester Paint - GROUP II
- door frame: CPL 0,2 mm - GROUP II
- door frame: Natural Veneer Black
- door frame: Natural Veneer Oak, Satin (other colours)
- door frame: Natural Veneer White Oak, Satin
- door frame: Natural Veneer Walnut
- door leaf: Gladstone/Halifax finishes, vertical graining
- door leaf: CPL 0,2 mm and 0,7 mm - GROUP II
- door leaf: model with crossed graining natural Veneer Oak, Ash, Walnut
- door leaf: model with crossed graining natural Veneer Select
- door leaf: Natural Veneer Oak, Satin (other colours)
- door leaf: Natural Veneer White Oak, Satin
- door leaf: Natural Veneer Walnut
- door leaf: Natural Veneer Select Black
- steel door frame profile for PROJECT BIS cover
- steel door frame profile for PROJECT Premium cover
- steel door frame profile from 101 to 150 mm
- steel door frame profile from 151 to 270 mm
- steel door frame profile from 271 to 390 mm
- steel door frame from 80 to 100 mm
- reinforcement for a door closer PORTA SYSTEM
- reinforcement for the door closer - door leaf 27 dB
- reinforcement for a door closer in a steel door frame handle with an escutcheon

without extra charge

(p. 217)

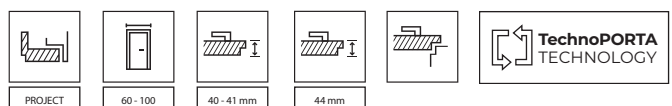



INNOVO 37 dB, Black

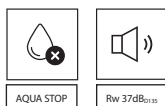

All available models - see p. 142

ACOUSTIC RATING OF INNOVO 37 dB DOOR:

- $R_w=37$ dB (37-41 dB)



cylinder lock



automatic treshold seal



three part hinges



three part hinges

AVAILABLE FINISHES

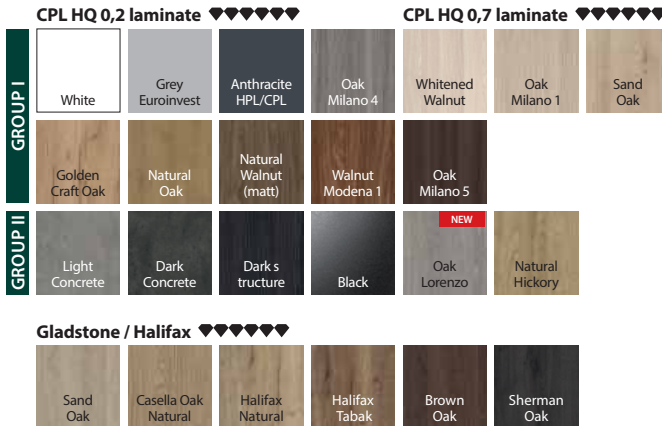

TECHNICAL INFORMATION

DOOR LEAF CONSTRUCTION

INNOVO core is special 3-layered sound proofing construction with rails and stiles made of glued laminated softwood. The construction is skinned with HDF. Available in rebated option. Side edges finished with liping ABS.

ACCESSORIES

- two or three 3-part hinges
- lock of the highest category of use - class 3 according to PN-EN 12209
- automatic threshold seal

DOOR FRAMES

- PORTA SYSTEM adjustable door frame for a wall thickness range from 120 to 300 mm.
- Corner profile steel door frame of 100mm wide profile. Made of steel sheet, galvanized on both sides, 1,5 mm thick.

NOTES

- Norm PN EN 14351-2:2018-12.
- In case of using different hardware to offered by PORTA, guarantee cards guidelines must be followed.
- Available options: solid or with decorative inlays.
- The door leaf is reinforced for installing a door closer.
- Doors are equipped with a lock with a 9x9 mm spindle. Any of dedicated PORTA handle require metal spindle adapter 9/8.
- **Thanks to TechnoPORTA AQUA STOP technology door leaves have lower edges protected against humidity.**

EXTRA CHARGES

- size '100'
- decorative inlays, for synthetic Veneer (for one side, for both sides, price 2x)
- door frame: Polyester Paint - GROUP II
- door frame: CPL 0,2 mm - GROUP II
- door leaf: Gladstone/Halifax finishes, vertical graining
- door leaf: CPL 0,2 mm and 0,7 mm - GROUP II
- steel door frame profile from 101 to 150 mm
- steel door frame profile from 151 to 270 mm
- steel door frame profile from 271 to 390 mm
- reinforcement for a door closer PORTA SYSTEM
- reinforcement for a door closer in a steel door frame handle with an escutcheon

(p. 217)



60 - 100

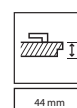

44 mm





SILENCE, Oak Milano 5 (bespoke solution, PORTA CONTRACT)

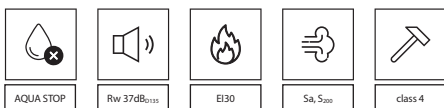

cylinder lock



heavy duty technical hinges



automatic threshold seal

All available models - see p. 142

ACOUSTIC RATING OF PORTA SILENCE DOOR:

- Rw=37 dB (37-41 dB)*

* Detailed tests results are available at the manufacturer.

SILENCE 37 dB, EI 30

AVAILABLE FINISHES

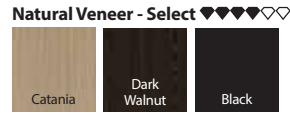

NOTE! Natural Veneer (excluding natural veneers: Ash and Walnut) are available with vertical and horizontal graining (applies to a door leaf).

Gladstone / Halifax ◆◆◆◆◆◆◆◆

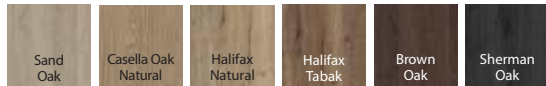

Natural Oak Satin Veneer ◆◆◆◆◆◆◆◆

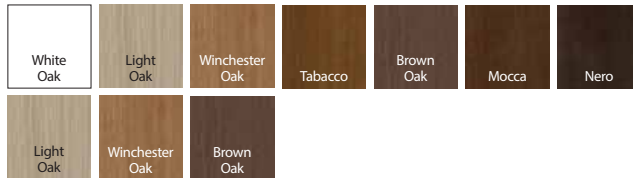

TECHNICAL INFORMATION

DOOR LEAF CONSTRUCTION

PORTA Silence® core is a special 5-layered sound proofing construction with rails and stiles made of glued laminated softwood. The construction is skinned with HDF. Available in rebated and non-rebated options. A door leaf finished with CPL HQ or Gladstone/Halifax has lipping ABS on the side edges.

ACCESSORIES

- two or three heavy duty technical hinges (PORTA SYSTEM door frame and non-rebated versions) or three 3 part hinges (rebated steel door frame)
- rebated version of MDF door frame – 4 barrel hinges
- lock of the highest category of use - class 3 according to PN-EN 12209
- automatic threshold seal

DOOR FRAMES

- A possibility of ordering a door frame in 2 options: rebated and non-rebated:
- PORTA SYSTEM adjustable door frame for a wall thickness range from 120 to 300 mm. Made of plywood.
- Corner profile steel door frame of 100mm wide profile. Made of steel sheet, galvanized on both sides, 1,5 mm thick.
- Fixed MDF door frame 100 mm.
- PROJECT BIS door frame, PROJECT Premium (p. 204).

NOTES

- Technical Assessment ITB-KOT-2017/0007 issue 2.
- National certification of constancy of performance No 020-UWB-0567/W.
- In order to meet the requirements of building law, regarding fire-rating and sound-proofness, it is necessary to use door closer.
- Door leaf and MDF door frame are reinforced for installing a door closer.
- Steel PORTA system and steel door frames can be reinforced for a door closer.
- Fire rated doors should be equipped with escutcheon with a steel core handle.
- In case of using different hardware to offered by PORTA, guarantee cards guidelines must be followed.
- Available options: flat, or with decorative inlays.
- Fire rated doors – inlays available only in both sides option.
- Doors are equipped with a lock with a 9x9 mm spindle. Any of dedicated PORTA handle require metal spindle adapter 9/8.
- **Thanks to TechnoPORTA AQUA STOP technology door leaves finished with synthetic veneers have lower edges protected against humidity.**

EXTRA CHARGES

- size '100'
- panoramic door viewer (synthetic veneers)
- decorative inlays, for natural veneers (on one side, both sides price x2)
- decorative inlays, for synthetic Veneer (for one side, for both sides, price 2x)
- door frame: Polyester Paint - GROUP II
- door frame: CPL 0,2 mm - GROUP II
- door frame: Natural Veneer Black
- door frame: Natural Veneer Oak, Satin (other colours)
- door frame: Natural Veneer White Oak, Satin
- door frame: Natural Veneer Walnut
- door leaf: Gladstone/Halifax finishes, vertical graining
- door leaf: CPL 0,2 mm and 0,7 mm - GROUP II
- door leaf: model with crossed graining Natural Veneer: Natural Veneer Oak, Ash, Walnut
- door leaf: model with crossed graining natural Veneer Select
- door leaf: Natural Veneer Oak, Satin (other colours)
- door leaf: Natural Veneer White Oak, Satin
- door leaf: Natural Veneer Walnut
- door leaf: Natural Veneer Select Black
- steel door frame profile for PROJECT BIS cover
- steel door frame profile for PROJECT Premium cover
- steel door frame profile from 101 to 150 mm
- steel door frame profile from 151 to 270 mm
- steel door frame profile from 271 to 390 mm
- handle with an escutcheon

(p. 217)

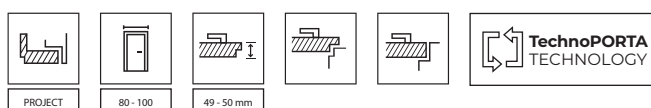



INNOVO 42 dB, Halifax Natural (bespoke solution PORTA CONTRACT)



AQUA STOP



Rw 42dB_{C135}



EI30*



S&K200**

* does not apply to the set with the PORTA SYSTEM door frame
 ** does not apply to set with PORTA SYSTEM and steel door frame



cylinder lock



automatic treshold seal



heavy duty technical hinges



heavy duty technical hinges

All available models - see p. 142

ACOUSTIC RATING:

- Rw=42 dB (42-46 dB)

AVAILABLE FINISHES

	CPL HQ 0,2 laminate ◆◆◆◆◆◆◆◆				CPL HQ 0,7 laminate ◆◆◆◆◆◆◆◆		
GROUP I	White	Grey Euroinvest	Anthracite HPL/CPL	Oak Milano 4	Whitened Walnut	Oak Milano 1	Sand Beech
	Golden Craft Oak	Natural Oak	Natural Walnut (matt)	Walnut Modena 1	Oak Milano 5		
GROUP II	Light Concrete	Dark Concrete	Dark structure	Black	NEW Oak Lorenzo	Natural Hickory	
	Gladstone / Halifax ◆◆◆◆◆◆◆◆						
	Sand Oak	Casella Oak Natural	Halifax Natural	Halifax Tabak	Brown Oak	Sherman Oak	

TECHNICAL INFORMATION

ACCESSORIES

- two heavy duty technical hinges - PORTA SYSTEM door frame; three 3-part hinges - steel door frame, 4 hinges - MDF door frame
- lock of the highest category of use - class 3 according to PN-EN 12209
- automatic threshold seal
- intumescent strip (under high temperature) - door leaf in the EI 30 option

DOOR FRAMES

- Reinforced adjustable PORTA SYSTEM door frame for a wall thickness range from 120 to 300 mm. Door frame beams made from plywood.
- Corner profile steel door frame of 100 mm wide profile. Made of 1.5 mm thick steel sheet. Standard option includes reinforcement for a door closer.
- MDF 100 mm fixed door frame equipped with hinge receivers with continuous 3D adjustment. It is possible to produce adjustable option of MDF frame for wall thickness from 160 mm - CONTRACT (bespoke) order.

NOTES

- Product is available with Individual Approval Documentation.
- Acoustic rating $R_w=42$ dB (range 42-46 dB).
- In order to meet the requirements of building law, regarding fire-rating and soundproofness, it is necessary to use a door closer.
- Door leaf and MDF door frame are reinforced for installing a door closer.
- Door leaf edges: door rails and stiles made of exotic or oak wood, colourless varnished or stained.

- Fire rated doors should be equipped with escutcheon with a steel core handle.
- In case of using different hardware to offered by PORTA, guarantee cards guidelines must be followed.
- Available options: solid or with decorative inlays.
- Doors are equipped with a lock with a 9x9 mm spindle. Any of dedicated PORTA handle require metal spindle adapter 9/8.
- **Thanks to TechnoPORTA AQUA STOP technology door leaves have lower edges protected against humidity.**

EXTRA CHARGES

size '100'
 decorative inlays, for synthetic Veneer (for one side, for both sides, price 2x)
 door frame: Polyester Paint - GROUP II
 door frame: CPL 0,2 mm - GROUP II
 door leaf: CPL 0,2 mm and 0,7 mm - GROUP II
 steel door frame profile from 101 to 150 mm
 steel door frame profile from 151 to 270 mm
 steel door frame profile from 271 to 390 mm
 reinforcement for a door closer PORTA SYSTEM
 reinforcement for a door closer in a steel door frame handle with an escutcheon

(p. 217)

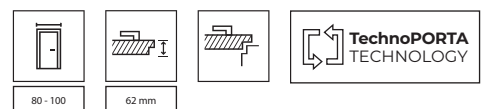



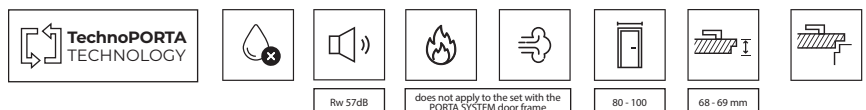

PURE 57 dB



It is possible to order doors with acoustic insulation PORTA PURE $R_w=57$ dB. The product is available in both standard and non-standard options.



Acoustic 42 dB, Natural Walnut (matt) (bespoke solution, PORTA CONTRACT)

			
AQUA STOP	Rw 42dB _{C,w}	EI30	Sa, S200
does not apply to the set with the PORTA SYSTEM door frame			



All available models - see p. 142

ACOUSTIC RATING:

- Rw=42 dB (42-46 dB)*

* Detailed tests results are available at the manufacturer.



cylinder lock



automatic treshold seals
(option with PORTA System door frame)



heavy duty technical hinges



automatic treshold seals
(option with steel door frame
and MDF door frame)

AVAILABLE FINISHES

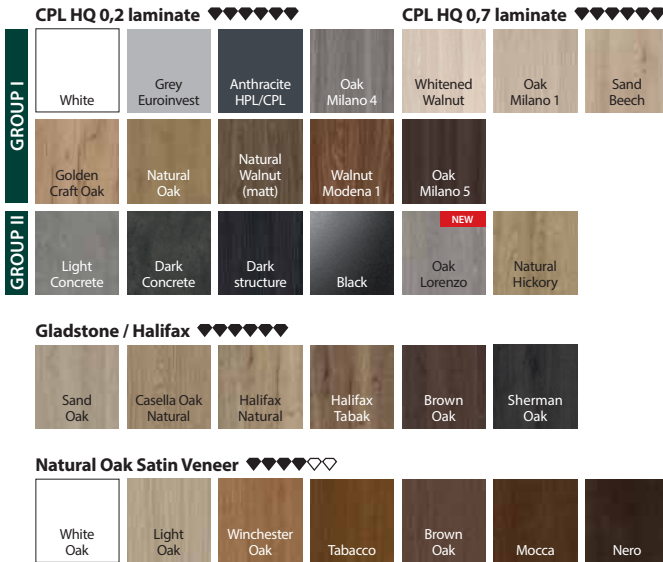

Natural Veneer - Select

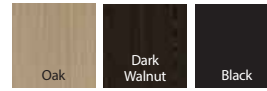

Natural Veneer

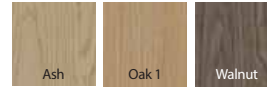

NOTE! Natural Veneer (excluding natural veneers: Ash and Walnut) are available with vertical and horizontal graining (applies to a door leaf).

TECHNICAL INFORMATION

ACCESSORIES

- two heavy duty technical hinges, three hinges for MDF (EI 30) door frame
- lock of the highest category of use - class 3 according to PN-EN 12209
- two automatic threshold seals
- rubber seal set circumferentially in door leaf and door frame rebates
- intumescent strip (under high temperature) - door leaf in the EI 30 option

DOOR FRAMES

- Reinforced adjustable PORTA SYSTEM door frame for a wall thickness range from 120 to 300 mm. Door frame beams made from plywood.
- Corner profile steel door frame of 120 mm wide profile. Made of steel sheet 1,5 mm thick. Standard option includes reinforcement for a door closer.
- MDF fixed door frame is equipped with hinge receivers with continuous 3D adjustment. It is possible to produce adjustable option of MDF frame for wall thickness from 160 mm - CONTRACT (bespoke) order.
- PROJECT BIS door frame, PROJECT Premium (p. 204).

NOTES

- Technical Assessment ITB-KOT-2017/0096 issue 2.
- National certification of constancy of performance No 020-UWB-2985/W (does not apply to 42 dB set with PORTA System door frame).
- Acoustic rating $R_w=42$ dB (range 42-46 dB).
- In order to meet the requirements of building law, regarding fire-rating and sound-proofness, it is necessary to use door closer.
- The door leaf is reinforced for installing a door closer.
- Door leaf edges: door rails and stiles made of exotic or oak wood, colourless varnished or stained.
- Fire rated doors should be equipped with escutcheon with a steel core handle.
- In case of using different hardware to offered by PORTA, guarantee cards guidelines must be followed.
- Doors are equipped with a lock with a 9x9 mm spindle. Any of dedicated PORTA handle require metal spindle adapter 9/8.
- **Thanks to TechnoPORTA AQUA STOP technology door leaves finished with synthetic veneers have lower edges protected against humidity.**

EXTRA CHARGES

- size '100'
- panoramic door viewer (synthetic veneers)
- decorative inlays, for natural veneers (on one side, both sides price x2)
- decorative inlays, for synthetic Veneer (for one side, for both sides, price 2x)
- door frame: Polyester Paint - GROUP II
- door frame: CPL 0,2 mm - GROUP II
- door frame: Natural Veneer Black
- door frame: Natural Veneer Oak, Satin (other colours)
- door frame: Natural Veneer White Oak, Satin
- door frame: Natural Veneer Walnut
- door leaf: CPL 0,2 mm and 0,7 mm - GROUP II
- door leaf: model with crossed graining natural Veneer Oak, Ash, Walnut
- door leaf: model with crossed graining natural Veneer Select
- door leaf: Natural Veneer Oak, Satin (other colours)
- door leaf: Natural Veneer White Oak, Satin
- door leaf: Natural Veneer Walnut
- door leaf: Natural Veneer Select Black
- steel door frame profile for PROJECT BIS cover
- steel door frame profile for PROJECT Premium cover
- steel door frame profile from 101 to 150 mm
- steel door frame profile from 151 to 270 mm
- steel door frame profile from 271 to 390 mm
- reinforcement for a door closer PORTA SYSTEM
- handle with an escutcheon

(p. 217)

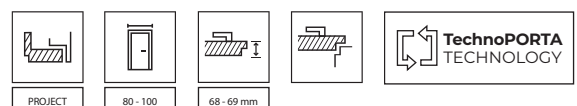



Fire-rated EI 30, Brown Oak



flush (EI 30)



model 2 (EI 60)



model 3 (EI 30,
EI 30 soft)



examples of glazings bespoke orders (EI30)

All available models - see p. 142

ACOUSTIC RATING OF EI 30 AND EI 60 DOORS:

- $R_w=32$ dB (32-36 dB)*

* Detailed tests results are available at the manufacturer.

Fire-rated EI 30, EI 60

AVAILABLE FINISHES



Natural Veneer - Select



Natural Veneer

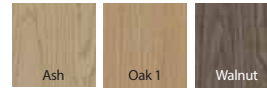

NOTE! Natural Veneer (excluding natural veneers: Ash and Walnut) are available with vertical and horizontal graining (applies to a door leaf).

TECHNICAL INFORMATION

ACCESSORIES

- hinges: two or three (EI 30); four (EI 30 soft, EI 60)
- cylinder lock
- transparent, fire-resistant glass panel, (fixed width, not dependent on door leaf size)
- intumescent strip (under high temperatures) - EI 30, R_w=42 dB option
- automatic threshold seal

A door leaf finished with CPL HQ or Gladstone/Halifax has lipping ABS on the side edges.

DOOR FRAMES

- MDF EI30 100 mm fixed door frame and adjustable one (min. 160 mm) (EI 30, EI 30 SOFT), equipped with adjustable hinges – heavy duty for EI 30 and adjustable barrelhinges for EI 30 SOFT.
- Wooden door frame 120 mm (EI 60), made of three-ply glued softwood, equipped with adjustable barrel hinges.
- Corner profile steel door frame of 100 mm wide profile. Made from hot dip galvanized steel sheet 1,5 mm thick. Equipped with three-part hinges, dowels pins and reinforced for door closer.
- PROJECT BIS door frame (p. 204).
- EI 30: PROJECT Premium door frame (p. 204) EI 60: PROJECT Premium door frame. Available with Individual Approval Documentation. Ordering through Contract department, Details available in Investment Catalogue and at Sales Departments.

NOTES

- EI 30 - Technical Assessment ITB-KOT-2017/0007 issue 2 and National certification of constancy of performance No 020-UWB-2978/W.
- EI 60 - Technical Assessment ITB-KOT-2018/0407 issue 2.
- National certification of constancy of performance No 020-UWB-2707/W.
- In order to meet the requirements of building law, regarding fire-rating and sound-proofness, it is necessary to use a door closer.
- The door leaf and door frames are reinforced for installing a door closer.
- Fire rated doors should be equipped with escutcheon with a steel core handle.
- In case of using different hardware to offered by PORTA, guarantee cards guidelines must be followed.
- Acoustic insulation class R_w=32 dB (range 32÷36 dB).
- EI 60 in size '100' is not available in standard offer (PORTA CONTRACT). Double EI 30 SOFT is not available.
- **Thanks to TechnoPORTA AQUA STOP technology door leaves finished with synthetic veneers have lower edges protected against humidity.**

EXTRA CHARGES

- double leaf door
- size '100' for EI 30
- panoramic door viewer (EI 60, synthetic veneers)
- third hinge in MDF door frame
- decorative inlays, for natural veneers (on one side, both sides price x2)
- decorative inlays, for synthetic Veneer (for one side, for both sides, price 2x)
- adjustable door frame: Natural Veneer White Oak, Satin
- door frame: Polyester Paint - GROUP II
- door frame: CPL 0,2 mm - GROUP II
- door frame: Natural Veneer, Black
- door frame: Natural Veneer Oak, Satin (other colours)
- door frame: Natural Veneer White Oak, Satin
- door frame: Natural Veneer Walnut
- door leaf: Gladstone/Halifax finishes, vertical graining
- door leaf: CPL 0,2 mm and 0,7 mm - GROUP II
- door leaf: model with crossed graining natural Veneer Oak, Ash, Walnut
- door leaf: model with crossed graining natural Veneer Select
- door leaf: Natural Veneer Oak, Satin (other colours)
- door leaf: Natural Veneer White Oak, Satin
- door leaf: Natural Veneer Walnut
- door leaf: Natural Veneer Select Black
- steel door frame profile for PROJECT BIS cover
- EI 30 steel door frame profile for PROJECT Premium cover
- steel door frame profile from 101 to 150 mm
- steel door frame profile from 151 to 270 mm
- steel door frame profile from 271 to 390 mm
- steel door frame from 80 to 100 mm
- quarter rounds, architraves
- handle with an escutcheon

without extra charge
(p. 207)
(p. 217)

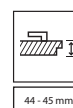
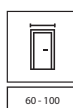



ENDURO, Anthracite

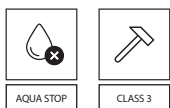

solid model 1 model 2 model 3 model 4

ENDURO - INDICATIONS FOR USE:
 • Laboratories
 • Dental clinics
 • Hospitals



push panel



kick panel



ventilation kick panel



ventilation grille

AVAILABLE FINISHES

HPL and CPL HQ laminate 0.7 ◆◆◆◆◆◆◆◆

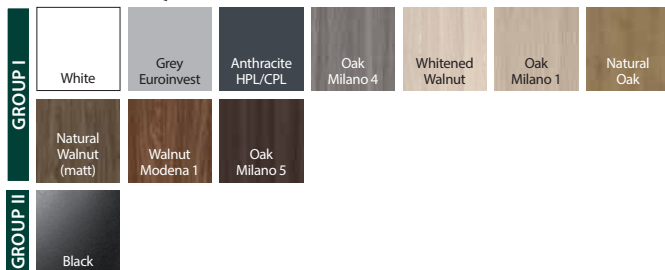

TECHNICAL INFORMATION

ACCESSORIES

- rebated option: reinforced three-part hinges (3 PCs)
- swinging option: two (size '60'), three ('70','80'), or four ('90') hinges
- transparent or frosted, tempered glass panel, (model 4 - laminated glass panel)
- lock: key lock, WC lock, cylinder lock
- reinforcement for a door closer included

DOOR FRAMES

- Corner profile steel door frame, profile: 105 mm wide. Made from galvanized steel sheet 1,2 mm thick. Equipped with 3 PCs of reinforced three-part hinges (which come with door leaf), rubber seal set circumferentially, six dowel pins. Powder coated (finishes charts see p. 235).
- Option of ordering two types of a door frame:
 - to install on finished floor level -'0'
 - to install below a floor level -'-'30'.

NOTES

- Norm PN EN 14351-2:2018-12, for swinging doors ITB-KOT-2017/0184 issue 2.
- Installation method of edge guards - without interference with Veneer structure.
- Maximum size of a swinging door leaf - '90'.
- **Thanks to TechnoPORTA AQUA STOP technology door leaves have lower edges protected against humidity.**

EXTRA CHARGES

- swinging version size '100'
- adjustable lock strike in a steel door frame
- door frame: Polyester Paint - GROUP II
- door leaf: HPL, CPL 0,7 mm - GROUP II
- steel door frame profile from 106 to 150 mm
- steel door frame profile from 155 to 270 mm
- steel door frame profile from 275 to 390 mm
- steel door frame from 80 to 100 mm
- reinforcement for a door closer in a steel door frame
- 'Kick-panel' (set for two sides)
- Ventilation 'kick panel' (set for two sides)
- push panel (set for two sides)
- stainless steel ventilation grille
- handle with an escutcheon

without extra charge

(p. 217)

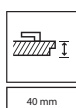
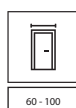



4th strength performance class, Anthracite, Edel handle



AQUA STOP



CLASS 4



reinforced 3-part hinge



lock with the top 3rd class of use category acc. to PN-EN 12209

4th strength performance class

AVAILABLE FINISHES

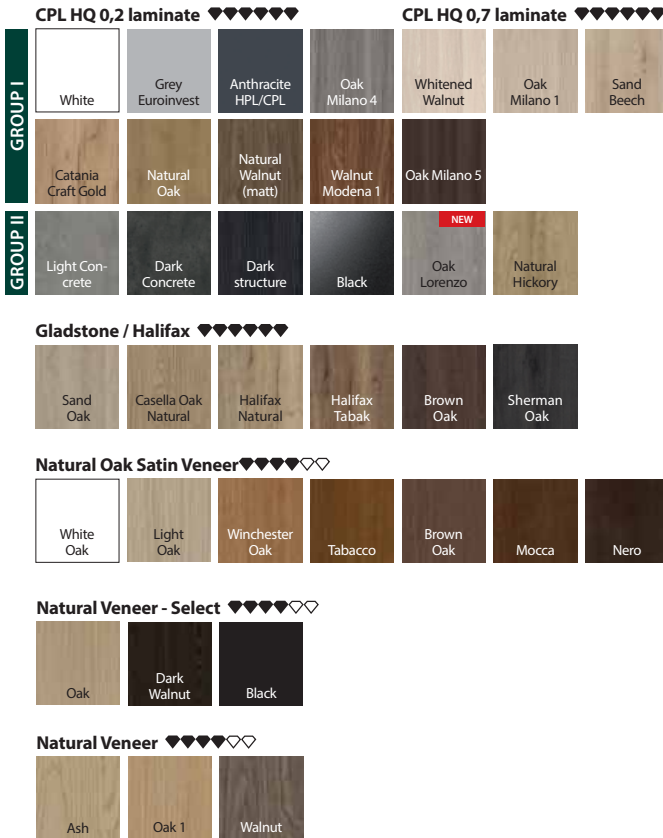

NOTE! Natural Veneer (excluding natural veneers: Ash and Walnut) are available with vertical and horizontal graining (applies to a door leaf).

TECHNICAL INFORMATION

DOOR LEAF CONSTRUCTION

The filling of the leaf is a hollow chipboard core or solid chipboard core (option at extra charge) reinforced with an internal stile. The whole is covered with HDF board (synthetic Veneer) or chipboard (Natural Veneer). Available in a rebated version.

ACCESSORIES

- two or three three-part hinges in technical placement
- lock of the highest category of use - class 3 according to PN-EN 12209

DOOR FRAMES

- Made of steel sheet galvanized on both sides, of thickness 1.5 mm:
- Corner profile steel door frame - LARGE
- Adjustable steel door frame
- PORTA SYSTEM steel door frame

NOTES

- Norm PN-EN 14351-2:2018-12.
- Steel panels available in '80', '90' and '100' sizes for CPL finish.
- Available only in the flush option.
- The door leaf is reinforced for installing a door closer.
- Product available only in investment norm.
- **Thanks to TechnoPORTA AQUA STOP technology door leaves finished with synthetic veneers have lower edges protected against humidity.**

EXTRA CHARGES

- size '100'
- ventilation undercut, sleeves
- replacing the hollow chipboard core with a solid chipboard (synthetic Veneer)
- door frame: Polyester Paint - GROUP II
- door leaf: Gladstone/Halifax finishes, vertical graining
- door leaf: CPL 0,2 mm and 0,7 mm - GROUP II
- door leaf: model with crossed graining natural Veneer Oak, Ash, Walnut
- door leaf: model with crossed graining natural Veneer Select
- door leaf: Natural Veneer White Oak, Satin
- door leaf: Natural Veneer Select Black
- kick panel - set for two sides (CPL)
- ventilation kick panel - set for two sides (CPL)
- kick panel with ventilation undercut - set for two sides (CPL)
- push panel - set for two sides (CPL)
- handle with an escutcheon

(p. 217)

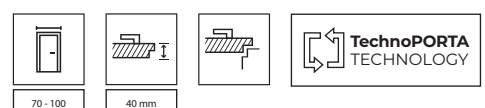



AGATE Solid, Sand Beech with a steel door frame

CERTIFIED
CPL

All available models - see p. 142



a lock with security pins - AGATE



dog bolts - AGATE, OPAL

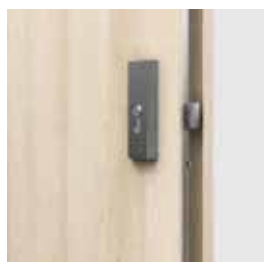

4 point lock - OPAL

adjustable strike - steel door frame
(optionally)

AGATE DOOR

Reinforced Agate door is equipped with locks with security pins. It is acoustic rated $R_w=32$ dB (32-36 dB).

OPAL DOOR

Doors with burglar resistance class RC2 according to PN EN 1627:2012 OPAL are also acoustic rated $R_w=32$ dB (32-36 dB).
Opal remain burglar-resistant only as a part of a complete set: steel door frame (suggested by PORTA), stainless steel threshold, a handle with an escutcheon (at least 2 class) and a cylinder (at least 4th class of burglary resistance).

WE RECOMMEND!

THANKS TO THE ALUMINIUM LAYER, DOORS ARE EXCEPTIONALLY RESISTANT TO ADVERSE CONDITIONS OF USE, TEMPERATURE AND HUMIDITY DIFFERENCES, WHICH ARE COMMON IN COMMUNAL AREAS.



AGATE

apartment entrance
doors 32 dB

OPAL

anti-burglary doors RC 2, 32 dB

AVAILABLE FINISHES

Portasynchro 3D Veneer ◆◆◆◆◆



Portaperfect 3D Veneer ◆◆◆◆◆

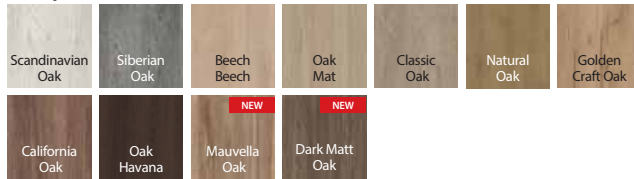

Gladstone / Halifax ◆◆◆◆◆



Natural Oak Satin Veneer ◆◆◆◆◆

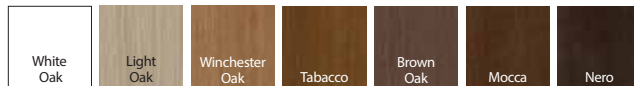

Portalamino ◆◆◆◆◆



Matt Lacquered Veneer ◆◆◆◆◆



CPL HQ 0,2 laminate ◆◆◆◆◆

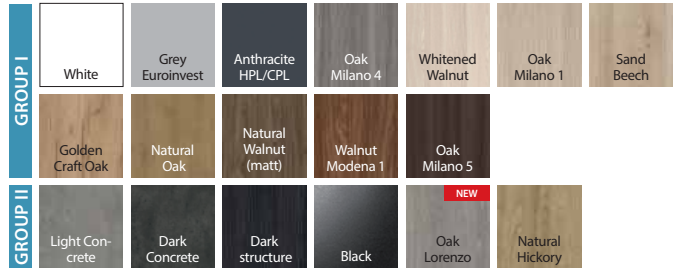

Natural Veneer - Select ◆◆◆◆◆

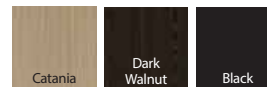

Natural Veneer ◆◆◆◆◆

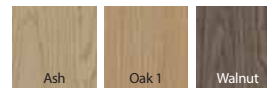

NOTE! Natural Veneer (excluding natural veneers: Ash and Walnut) are available with vertical and horizontal graining (applies to a door leaf).

TECHNICAL INFORMATION

DOOR LEAF CONSTRUCTION

Door leaf frame is made of glued laminated softwood. It is reinforced with stiles. Doorleaf is skinned with a layer of aluminium sheet and wood-based board. Door leaves with silver decorative inlays are available. Natural veneers are finished with semi-matt varnish. A door leaf finished with CPL HQ or Gladstone/Halifax has lipping ABS on the side edges.

ACCESSORIES INCLUDED IN THE AGATE DOOR PRICE

- one or two locks with security pins
- three barrel hinges
- three dog bolts
- door frame equipped with a standard stainless steel threshold (90 mm)

ACCESSORIES INCLUDED IN OPAL DOOR PRICE

- 4 point lock - for two cylinders
- three barrel hinges
- three dog bolts
- steel door frame equipped with stainless steel threshold (90 mm)

DOOR FRAMES

- Corner profile steel door frame, profile: 105 mm wide. Made from both sides galvanized steel sheet 1,2 mm thick (AGATE) or 1,5 mm thick (OPAL).
- Equipped with three barrel hinges, rubber seal set circumferentially. OPAL is additionally equipped with six dowel pins.
- PROJECT BIS, PROJECT PREMIUM door frames (see p. 204)

NOTES

- Technical Assessment ITB-KOT-2017/0096 issue 2.
- Preparation for shortening (maximum 60 mm).
- Acoustic rating $R_w=32$ dB (32÷36 dB).
- Threshold is a part of steel AGATE/OPAL door frame.
- **Thanks to TechnoPORTA AQUA STOP technology door leaves finished with synthetic veneers have lower edges protected against humidity.**

EXTRA CHARGES

- size '100' cylinders
- door viewer
- equipping AGATE door frame with 6 mounting dowels, adjustable lock strike in a steel door frame
- decorative inlays in Natural veneers for natural veneers (on one side, both sides price x2)
- decorative inlays in synthetic veneers (for 1 side, for both sides – price x 2)
- door frame: Polyester Paint - GROUP II
- door leaf: Gladstone/Halifax finishes, with vertical graining
- door leaf: CPL 0,2 mm and 0,7 mm - GROUP II
- door leaf: model with crossed graining, Natural Veneer: Oak, Oak, Ash, Walnut
- door leaf: model with crossed graining, natural Veneer Select
- door leaf: Natural Veneer White Oak, Satin
- door leaf: Natural Veneer Oak, Satin (other colours)
- door leaf: Natural Veneer Walnut
- door leaf: Natural Veneer, Select Black
- steel door frame profile for PROJECT BIS cover
- steel door frame for PROJECT Premium cover
- steel door frame profile from 106 to 150 mm
- steel door frame profile from 151 to 270 mm
- steel door frame profile from 271 to 390 mm
- reinforcement for a door closer (steel door frame)
- reinforcement for a door closer in the leaf handle

contract option
(p. 218)

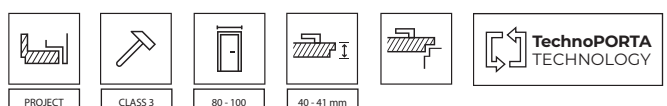



EXTREME RC2, Solid, Oak Milano 1 with a steel door frame

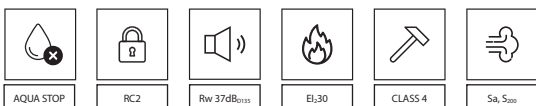

All available models - see p. 142



lower lock - 3 security pins



upper lock - 3 security pins



dog bolts

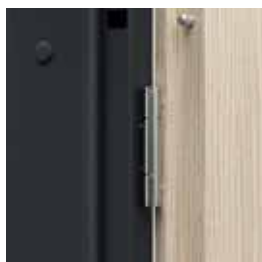

3 PCs of three-part hinges



stainless steel threshold (120 mm)

EXTREME RC 2 doors

Extreme RC2 doors are equipped with 2 locks with 3 security pins and dog bolts.

There are two types:

- Type I
 - class RC 2 as per DIN EN 1627:2012
 - sound insulation class $R_w=37$ dB (37-41 dB)*.
- Type II
 - characteristics of type I doors
 - fire resistance EI 30
 - smoke control

* Detailed tests results are available at the manufacturer.

WE RECOMMEND!

THANKS TO THE ALUMINIUM LAYER, RC 2 DOORS ARE EXCEPTIONALLY RESISTANT TO ADVERSE CONDITIONS OF USE, TEMPERATURE AND HUMIDITY DIFFERENCES, WHICH ARE COMMON IN COMMUNAL AREAS.



EXTREME RC 2

anti-burglary doors, class RC 2, 37 dB, EI 30

AVAILABLE FINISHES



Natural Veneer - Select

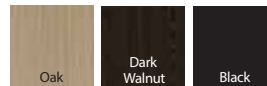

Natural Veneer

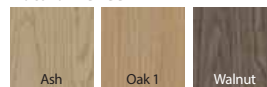

NOTE! Natural Veneer (excluding natural veneers: Ash and Walnut) are available with vertical and horizontal graining (applies to a door leaf).

TECHNICAL INFORMATION

DOOR LEAF CONSTRUCTION

Core: special, 5-layer construction with rails and stiles made of glued laminated softwood, The construction is skinned with HDF. Available in rebated option. A door leaf finished with CPL HQ or Gladstone/Halifax has lipping ABS on the side edges.

ACCESSORIES INCLUDED IN THE DOOR PRICE

- two locks with security pins (handle spacing 72 mm)
- silver three-part hinges (3 PCs)
- four dog bolts
- a door frame
- standard stainless steel threshold (120 mm)
- additionally, Type II - an intumescent strip under the influence of high temperature on the edges of the leaf (except the lower edge)

DOOR FRAMES

- Corner profile, steel door frame with a profile width 100 mm. Made from both sides galvanized steel sheet 1,5 mm thick.
- Equipped with three three-part hinges, self- Adhesive gasket and eight dowel pins.
- PROJECT BIS door frame, PROJECT Premium see p. 204

NOTES

- Technical Assessment ITB-KOT-2017/0007 issue 2 and National certification of constancy of performance No 020-UWB-2978/W.
- Acoustic insulation class $R_w=37$ dB (range 37÷41dB).
- In order to meet the requirements of building law, regarding fire-rating and sound-proofness, it is necessary to use a door closer.
- Door leaf and door frame is reinforced for a door closer.
- In case of using different hardware to offered by PORTA, guarantee cards guidelines must be followed.
- Fire rated doors – inlays available only in both sides option.
- **Thanks to TechnoPORTA AQUA STOP technology door leaves finished with synthetic veneers have lower edges protected against humidity.**

EXTRA CHARGES

- size '100'
- door viewer
- panoramic door viewer (synthetic veneers)
- panoramic door viewer - black (synthetic veneers)
- decorative inlays, Natural Veneer (both sides)
- decorative inlays, synthetic Veneer (for 1 side, for both sides – price x 2)
- door frame: Polyester Paint - GROUP II
- door leaf: Gladstone/Halifax finishes, vertical graining
- door leaf: CPL 0,2 mm and 0,7 mm - GROUP II
- door leaf: model with crossed graining, natural Veneer Oak, Ash, Walnut
- door leaf: model with crossed graining, natural Veneer Select
- door leaf: Natural Veneer White Oak, Satin
- door leaf: Natural Veneer Oak, Satin (other colours)
- door leaf: Natural Veneer Walnut
- door leaf: Natural Veneer Select Black
- steel door frame profile for PROJECT BIS cover
- steel door frame for PROJECT Premium cover
- steel door frame profile from 106 to 150 mm
- steel door frame profile from 151 to 270 mm
- steel door frame profile from 271 to 390 mm
- spring-loaded door closer
- spring-loaded door closer, black
- black cylinders
- changing the colour of the hinges to black
- door handle with escutcheon (72 mm spacing)

(p. 218)

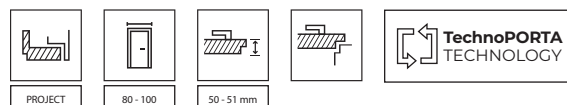



Steel SECURE A.0 with a door viewer, Structured Black

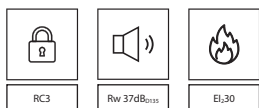

multipoint lock with two cylinders



reinforced 3-part hinge

dog bolt

NOTE: thanks to dedicated mounting dowels, the door frame does not have additional holes and plugs.



spring-loaded door closer



spring-loaded door closer



hook

Steel SECURE DOORS

Doors are equipped with multipoint lock and two cylinders class C.

- They have: RC3 class according to PN EN 1627:2012
- acoustic rating $R_w=37\text{dB}$ (37-41 dB)
- fire resistance EI 30

AVAILABLE FINISHES

Premium Polyester Paint ♥♥♥♥♥



Laminated steel sheet (PVC) ♥♥♥♥♥

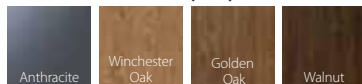

PROTECTION SYSTEM OF STEEL SURFACES

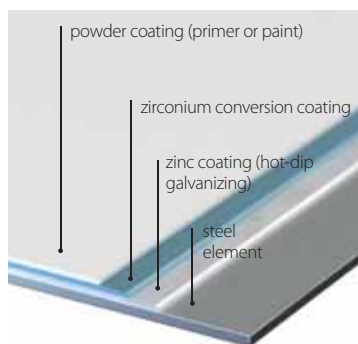

TECHNICAL INFORMATION

DOOR LEAF CONSTRUCTION

The construction is based on double layer wooden rails and stiles. The core is multilayer, based on mineral wool. The construction is skinned with galvanized steel sheet 0,6 mm - film laminated (PVC) or coated with a polyester Paint.

ACCESSORIES INCLUDED IN THE DOOR PRICE

- three-part hinges (3 PCs)
- multipoint lock
- four dog bolts
- 'SECURE' handle
- cylinders class C
- stainless steel threshold
- reinforcement for a door closer (door leaf and door frame)

DOOR FRAMES

Corner profile steel door frame, profile 100mm wide. Made from, both sides galvanized steel sheet 1,5 mm thick.
Door frames powder painted with Premium Polyester Paint.

NOTES

- Norm PN-EN 14351-2:2018-12; Norm PN-EN 16034:2014-11.
- National Certificate of Constancy of Performance No. 020-UWB-2919/W.

EXTRA CHARGES

- size '100'
- upper cylinder
- upper additional lock
- upper escutcheon
- door viewer
- Polyester Paint - GROUP II
- spring-loaded door closer

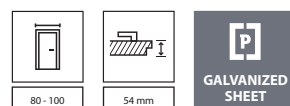



QUARTZ, decorative inlays 6, with a steel door frame



CERTIFIED
CPL

All available models - see p. 142



Four point lock with two cylinders - QUARTZ III



dog bolts - QUARTZ III



reinforced three-part hinge

QUARTZ doors

DT-PP-DY/M (QUARTZ type I and type II) doors are equipped with one or two cylinder locks.

- They have following qualities:
- acoustic rating $R_w=32$ dB (32-36 dB)
- fire resistance EI 30
- smoke control

DT-K32 (QUARTZ type III) doors are equipped with a multipoint lock and dog bolts.

- They have following qualities:
- burglary resistance - class RC 2 according to PN EN 1627:2012
- acoustic rating $R_w=32$ dB (32-36 dB)
- fire resistance EI 30
- smoke control

Burglary resistance class RC 2 (type III)
Acoustic rating $R_w=34$ dB*
Fire-resistance EI 30
Smoke control

WE RECOMMEND!

THANKS TO THE ALUMINIUM LAYER, QUARTZ DOORS ARE EXCEPTIONALLY RESISTANT TO ADVERSE CONDITIONS OF USE, TEMPERATURE AND HUMIDITY DIFFERENCES, WHICH ARE COMMON IN COMMUNAL AREAS.



AVAILABLE FINISHES

Okleina Portasyntro 3D



Okleina Portaperfect 3D

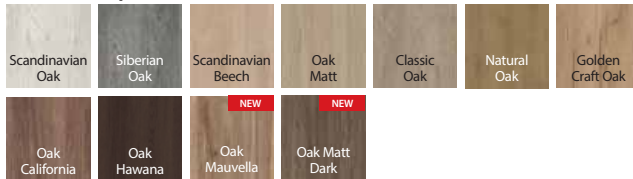

Gladstone / Halifax

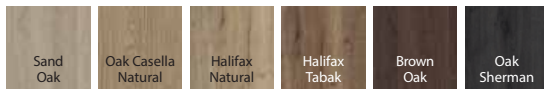

Natural Satin Oak Veneer

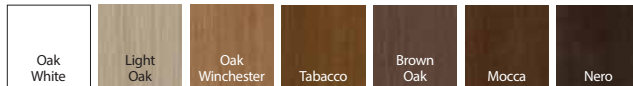

Portalamino

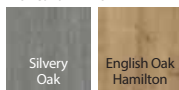

Okleina Lakierowana Matt

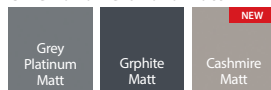

NOTE! Natural veneers (except Ash and Walnut) are available in vertical or horizontal grain direction (applies only to door leaf)

CPL HQ 0,2 laminate

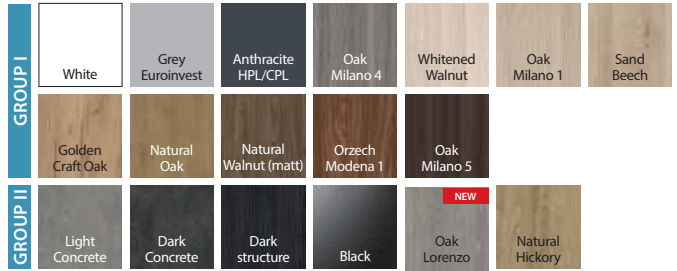

CPL 0,7 laminate

NOTE! It is recommended to choose CPL or Gladstone/Halifax laminate for entrance door, especially if they are used in public buildings.

TECHNICAL INFORMATION

DOOR LEAF CONSTRUCTION

Core: Multilayer construction which provides fire-resistance of 30 min and acoustic insulation of $R_w=34$ dB*. Thanks to a layer of aluminium sheet door leaves are extremely resistant to adverse conditions of use that are characteristic for communal areas. A door leaf finished with CPL HQ or Gladstone/Halifax has lipping ABS on the side edges.

ACCESSORIES INCLUDED IN DOOR PRICE

- a mortise cylinder lock with a rectangular deadbolt and (QUARTZ Type I)
- two cylinder mortise locks with rectangular deadbolts (QUARTZ Type II)
- a 4-point lock with two cylinders and three dog bolts (QUARTZ Type III)
- reinforced, silver three-part hinges (3 PCs)
- an intumescent seal in a door leaf rebate
- a door frame with a standard stainless steel threshold (90 mm)

DOOR FRAMES

- Corner profile steel door frame, profile 105mm wide. Made from both sides galvanized steel sheet 1,5 mm thick. Equipped with self-extinguishing gasket, three 3-part hinges, stainless steel threshold - standard 90 mm, reinforcement for a door closer. QUARTZ I has one lock strike, QUARTZ II - two lock strikes, QUARTZ III multipoint lock strike, six dowel pins and receivers for dog bolts.
- PROJECT BIS, PROJECT Premium door frames (p. 204)

NOTES

- Technical Assessment ITB-KOT-2017/0007 issue 1.
- National certification of constancy of performance No 020-UWB-0567/W
- In order to meet the requirements of building law, regarding fire-rating and/or smoke control, it is necessary to use a door closer.
- In case of using different hardware to offered by PORTA, guarantee cards guidelines must be followed.

- Fire rated doors should be equipped with an escutcheon and a handle with a steel spindle.
- Acoustic rating $R_w=32$ dB (32-36 dB).

EXTRA CHARGES

- door viewer size '100'
- door leaf: CPL 0,2 mm and 0,7 mm veneers – GROUP II
- door leaf: Gladstone/Halifax finish, vertical graining
- decorative inlays for synthetic veneers (for 1 side, for both sides – the price x 2)
- decorative inlays for Natural veneers (for 1 side, for both sides – the price x 2)
- door leaf: Natural Veneer, White Oak, Satin
- door leaf: Natural Veneer, Oak, Satin (other colours)
- door leaf: Natural Veneer, Walnut
- door leaf: Natural Veneer, Select Black
- steel door frame: polyester Paint- GROUP II
- steel door frame: polyester Paint- GROUP III
- steel door frame profile for PROJECT BIS cover
- steel door frame profile for PROJECT PREMIUM cover
- steel door frame profile from 101 to 150 mm
- steel door frame profile from 151 to 270 mm
- steel door frame profile from 271 to 390 mm
- door leaf: model with crossed graining, Natural Select Veneer
- door leaf: model with crossed graining, Natural Veneer Oak, Ash, Walnut a handle with an escutcheon (see p. 218)

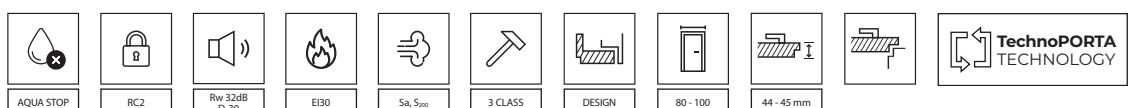



EXTREME RC 3, Natural Hickory, with PS reinforced door frame (bespoke solution PORTA CONTRACT)

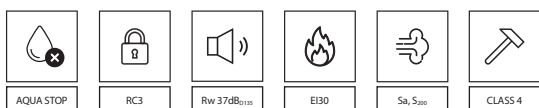

All available models - see p. 142



2 anti-burglary hooks



Winkhaus multipoint lock with hooks



Spring loaded door closer with a steel door frame (available silver and black)



4 dog bolts

EXTREME DOORS

come in two types:

Type I

- RC3 class in accordance with PN EN 1627-2012
- acoustic insulation class $R_w=37$ dB (37-41 dB)*
- smoke control

Type II

- features of type I
- fire resistance EI 30

*Detailed tests results are available at the manufacturer.

EXTREME RC 3

anti-bulglary doors class RC 3, EI 30, 37 dB

AVAILABLE FINISHES



Natural Veneer - Select



Natural Veneer

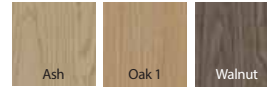

NOTE! Natural Veneer (excluding natural veneers: Ash and Walnut) are available with vertical and horizontal graining (applies to a door leaf).

TECHNICAL INFORMATION

DOOR LEAF CONSTRUCTION

Core: special 5-layer construction with rails and stiles made of glued laminated softwood. The construction is skinned with HDF. Available in rebated option. A door leaf finished with CPL HQ or Gladstone/Halifax has lipping ABS on the side edges.

ACCESSORIES INCLUDED IN THE PRICE OF THE LEAF

- hook lock with a pressure adjustment, and an additional upper lock
- two anti-burglary cylinders
- a handle with an anti-burglary escutcheon 'SAFE' (spacing 92 mm)
- 3 PCs of three-part hinges (steel door frame) or 2 PCs of heavy duty hinges (reinforced PS frame). Both options - silver.
- four dog bolts
- additionally: type II - high temperature intumescent seal on door leaf edges (apart from bottom edge)
- door frame is equipped with a standard stainless steel threshold (90 mm) and reinforcement for a door closer

DOOR FRAMES

- Corner profile steel door frame of 100mm wide profile. Made from both sides galvanized steel sheet 1,5 mm thick. Equipped with self-Adhesive gasket, eight dowel pins and a stainless steel threshold (120 mm).
- Reinforced PORTA system door frame with an adjustment range 120-300 mm, equipped with stainless steel threshold (100 mm). Architraves 80 mm wide.
- PROJECT BIS door frame, PROJECT Premium (see p. 204).

NOTES

- Technical Assessment ITB-KOT-2017/0007 issue 2.
- National certification of constancy of performance No 020-UWB-2978/W
- In order to meet the requirements of building law, regarding fire-rating and soundproofness, it is necessary to use a door closer.
- Door leaf and a door frame is reinforced for a door closer.
- Fire-rated door - decorative inlays are available only as an option for both sides.
- **Thanks to TechnoPORTA AQUA STOP technology door leaves finished with synthetic veneers have lower edges protected against humidity.**

EXTRA CHARGES

- size '100'
- upper cylinder
- upper additional lock
- upper escutcheon
- door viewer
- panoramic door viewer (synthetic veneers)
- panoramic door viewer - black (synthetic veneers)
- decorative inlays, Natural Veneer (both sides)
- decorative inlays, for synthetic Veneer (for one side, for both sides, price 2x)
- door frame: Polyester Paint - GROUP II
- door frame: CPL 0,2 mm - GROUP II
- door frame: Natural Veneer, black
- door frame: Natural Veneer Oak, Satin (other colours)
- door frame: Natural Veneer White Oak, Satin
- door frame, finish: Natural Veneer Walnut
- door leaf: Gladstone/Halifax finishes, vertical graining
- door leaf: CPL 0,2 mm and 0,7 mm - GROUP II
- door leaf: model with crossed graining, natural Veneer Oak, Ash, Walnut
- door leaf: model with crossed graining, natural Veneer Select
- door leaf: Natural Veneer White Oak, Satin
- door leaf: Natural Veneer Oak, Satin (other colours)
- door leaf: Natural Veneer Walnut
- door leaf: Natural Veneer Select Black
- steel door frame profile for PROJECT BIS cover
- steel door frame for PROJECT Premium cover
- steel door frame profile from 101 to 150 mm
- steel door frame profile from 151 to 270 mm
- steel door frame profile from 271 to 390 mm
- spring-loaded door closer
- spring-loaded door closer, black
- black cylinders
- black cylinder (single insert)
- changing the colour of the hinges to black
- door handle with SAFE escutcheon (spacing 92 mm)

(p. 218)

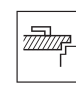
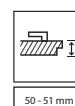
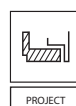



EXTREME RC 4, Anthracite (bespoke solution, PORTA CONTRACT)

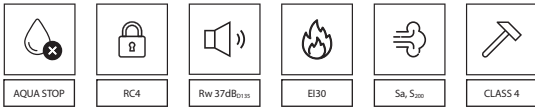

dedicated handle and multipoint lock



interlocking hooks



reinforced, heavy-duty hinges



lock hook adjustable strikes



stainless steel threshold (120 mm)

EXTREME RC4 doors

we offer two types:

Type I

- RC4 burglary resistance class according to PN EN 1627-2012
- Acoustic rating $R_w=37$ dB (37–41 dB)*
- smoke control

Type II

- Type I qualities
- fire-resistance EI 30

* Detailed test results available from the manufacturer

EXTREME RC 4

anti-burglary doors, class RC 4, EI 30, 37 dB

AVAILABLE FINISHES

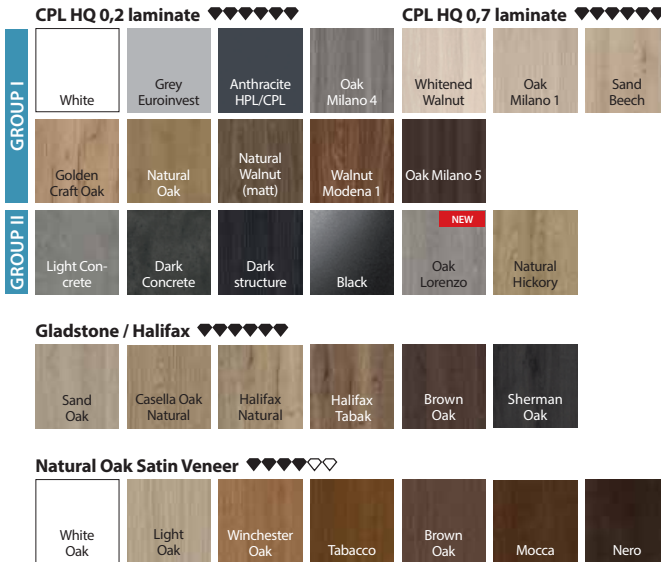

Natural Veneer - Select

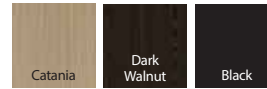

Natural Veneer

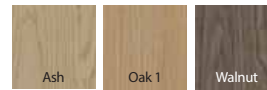

NOTE! Natural Veneer (excluding natural veneers: Ash and Walnut) are available with vertical and horizontal graining (applies to a door leaf).

TECHNICAL INFORMATION

DOOR LEAF CONSTRUCTION

Core: special 5-layer construction with rails and stiles made of glued laminated softwood, skinned with HDF and aluminium sheet. Core is also reinforced with steel rods. The construction is skinned with HDF with aluminium sheet.

ACCESSORIES INCLUDED IN THE DOOR PRICE

- multipoint hook lock
- heavy duty technical hinges
- 5 PCs of dog bolts
- cylinder insert
- dedicated handle
- additionally: type II - high temperature intumescent seal on door leaf edges

DOOR FRAMES

Corner profile steel door frame. Made from both sides galvanized steel sheet 1,5 mm thick. Equipped with self-Adhesive gasket, eight dowel pins and, adjustable catch of lock hooks and stainless steel threshold.

NOTES

- Norm PN EN 14351-2:2018-12 and PN EN 16034:2014-11.
- National Certificate of Constancy of Performance No. 020-UWB-2950/W.
- In order to meet the requirements of building law, regarding fire-rating and/or smoke control, it is necessary to use a door closer or a closing device.
- RC4 burglary resistance is provided for inward opening doors.
- Door leaf and door frame are prepared for a door closer
- In case of using different hardware to offered by PORTA, guarantee cards guideline-must be followed.
- **Thanks to TechnoPORTA AQUA STOP technology door leaves finished with synthetic veneers have lower edges protected against humidity.**

EXTRA CHARGES

- size '100'
- upper cylinder
- upper additional lock
- upper escutcheon
- door viewer
- panoramic door viewer (synthetic veneers)
- decorative inlays, for natural veneers (on one side, both sides price x2)
- decorative inlays, for synthetic Veneer (for one side, for both sides, price 2x)
- door frame: Polyester Paint - GROUP II
- door leaf: Gladstone/Halifax finishes, vertical graining
- door leaf: CPL 0,2 mm and 0,7 mm - GROUP II
- door leaf: model with crossed graining, natural Veneer Oak, Ash, Walnut
- door leaf: model with crossed graining, natural Veneer Select
- door leaf: Natural Veneer White Oak, Satin
- door leaf: Natural Veneer Oak, Satin (other colours)
- door leaf: Natural Veneer Walnut
- door leaf: Natural Veneer Select Black
- steel door frame profile for PROJECT BIS cover
- steel door frame for PROJECT Premium cover
- steel door frame profile from 101 to 150 mm
- steel door frame profile from 151 to 270 mm
- steel door frame profile from 271 to 390 mm
- spring-loaded door closer

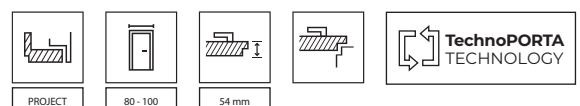



GRANITE class C, Natural Walnut with a door frame and a PROJECT BIS door frame cover



CERTIFIED
CPL

All available models - see p. 142

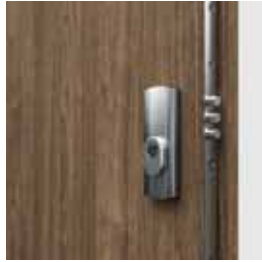
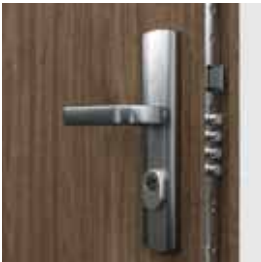

two cylinder multipoint lock with security pins

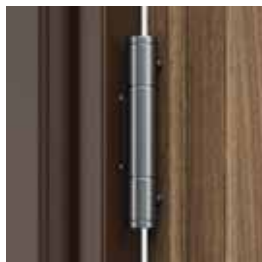

dog bolts

reinforced 3-part hinge

GRANITE DOORS, class C

we offer two types:

Type I

- GRANITE DOORS cl. C
- RC3 burglary resistance class according to PN EN 1627-2012
- Acoustic rating $R_w=32$ dB (32-36 dB)*
- smoke control

Type II

- Type I qualities
- Fire-resistance EI 30

* Detailed tests results are available at the manufacturer.

WE RECOMMEND!

THANKS TO THE ALUMINIUM LAYER, GRANITE DOORS ARE EXCEPTIONALLY RESISTANT TO ADVERSE CONDITIONS OF USE, TEMPERATURE AND HUMIDITY DIFFERENCES, WHICH ARE COMMON IN COMMUNAL AREAS.



GRANIT Class C

anti-burglary doors, class C, EI 30, 32 dB

AVAILABLE FINISHES



Natural Veneer - Select ◆◆◆◆◆◇◇

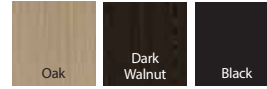

Natural Veneer ◆◆◆◆◆◇◇

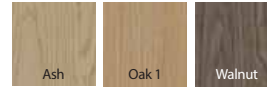

NOTE! Natural Veneer (excluding natural veneers: Ash and Walnut) are available with vertical and horizontal graining (applies to a door leaf).

Natural Oak Satin Veneer ◆◆◆◆◆◇◇

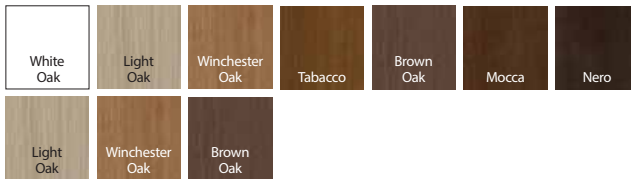

TECHNICAL INFORMATION

DOOR LEAF CONSTRUCTION

Rails and stiles made of glued softwood. The construction is skinned with special double layer aluminium sheet and HDF. Silver decorative inlays available. Natural veneers are finished with semi-matt varnish.

ACCESSORIES INCLUDED IN DOOR PRICE

- multipoint lock with security pins, class 4
- two anti-burglary cylinders, class 'C'
- a handle with an anti-burglary escutcheon 'GRANITE'
- upper escutcheon
- silver three-part hinges (3 PCs)
- four dog bolts
- preparation for shortening, maximum 60 mm (regards Granite type I)
- additionally: type II - high temperature intumescent seal on door leaf edges
- door frame equipped with a stainless steel threshold, (wider option- 120 mm) and reinforcement for a door close

DOOR FRAMES

- Corner profile, steel door frame with a profile width 100 mm. Made from galvanized steel sheet 1,5 mm thick. Equipped with self-Adhesive gasket, eight dowel pins and a stainless steel threshold (120 mm).
- PROJECT BIS door frame (see p. 204).
- PROJECT Premium (see p. 204).

NOTES

- Technical Assessment ITB-KOT-2017/0242 issue 2.
- National certification of constancy of performance No 020-UWB-2618/W.
- In order to meet the requirements of building law, regarding fire-rating and sound-proofness, it is necessary to use door closer.
- Door leaf and door frame is reinforced for a door closer.
- Fire rated doors should be equipped with escutcheon with a steel core handle.
- In case of using different hardware to offered by PORTA, guarantee cards guidelines must be followed.
- Acoustic rating $R_w=32$ dB (32÷36 dB).
- **Thanks to TechnoPORTA AQUA STOP technology door leaves finished with synthetic veneers have lower edges protected against humidity.**

EXTRA CHARGES

- size '100'
- door viewer
- panoramic door viewer
- adjustable lock strike (Type I)
- decorative inlays, for natural veneers (on one side, both sides price x2)
- decorative inlays, for synthetic Veneer (for one side, for both sides, price 2x)
- door frame: Polyester Paint - GROUP II
- door leaf: CPL 0,2 mm and 0,7 mm - GROUP II
- door leaf: model with crossed graining, natural Veneer Oak, Ash, Walnut
- door leaf: model with crossed graining, natural Veneer Select
- door leaf: Natural Veneer White Oak, Satin
- door leaf: Natural Veneer Oak, Satin (other colours)
- door leaf: Natural Veneer Walnut
- door leaf: Natural Veneer Select Black
- steel door frame profile for PROJECT BIS cover
- steel door frame for PROJECT Premium cover
- steel door frame profile from 101 to 150 mm
- steel door frame profile from 151 to 270 mm
- steel door frame profile from 271 to 390 mm

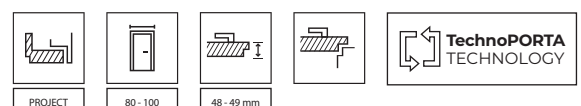

TECHNICAL STEEL DOORS

11

→ Discover **the advantages of** PORTA steel products



DURABLE FINISH TECHNOLOGY

- ✓ High quality and **durability confirmed by tests**. **Galvanized steel sheet** is used in all our steel products.
- ✓ **Various finishes:** polyester Paint, stainless steel, PVC laminated steel sheet, coated steel sheet.



GUARANTEE OF QUALITY

- ✓ Precision of the production of a chosen solution and durability of anti-corrosion protection.
- ✓ **High performance parameters** and technical characteristics.

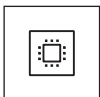

UP-TO-DATE DESIGN

- ✓ **A wide range of colours of the highest quality Polyester Premium paints: matt, gloss, texture.**
- ✓ Possibility of manufacturing in accordance with the architectural design. Indications for use: public buildings, residential buildings, shopping centres, garages.



EASY INSTALLATION

- ✓ **Efficient and quick installation** – product manufactured in accordance with applicable standards.
- ✓ Possibility of installation on brick, concrete and plasterboard walls. **Dedicated accessories** increasing the functionality of the door.



03 / LABORATORIUM



TIP! Shop CONVENIENTLY
as a set door + handle



Doors for utility model 2, Grey

Included in the door set price

- door leaf
- door frame
- handle
- lock



Industrial pattern
W.121254



handle



ventillation grille

right or left?
reversible!

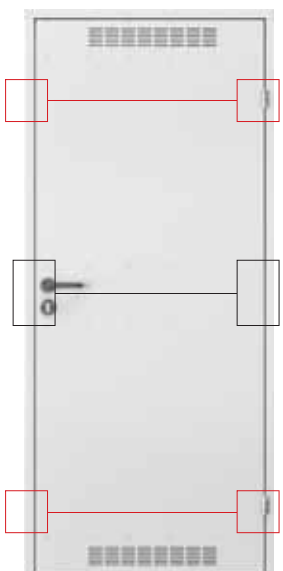

hinge socket

lock strike

hinge socket

front of a door leaf



back of a door leaf

PROTECTION SYSTEM OF STEEL SURFACES

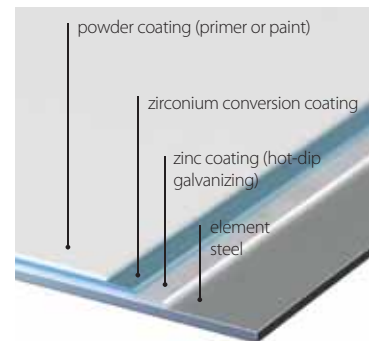

Doors for utility rooms and storage rooms

AVAILABLE FINISHES

Galvanized steel sheet ♥♥♥♥♥



Premium Polyester Paint ♥♥♥♥♥

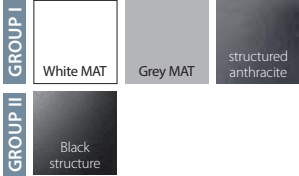

TECHNICAL INFORMATION

A DOOR SET INCLUDES

- Door leaf (paint coated galvanized steel sheet)
- Ventilation grille (optional)
- Two standard barrel hinges
- cylinder lock
- Economical, plastic handle with a round escutcheon
- Corner profile frame

DOOR FRAME

- Corner profile frame, profile 48 mm wide. Made of 0,8 mm thick steel sheet, bothsides galvanized.

NOTES

- Norm PN EN 14351-2:2018-12.
- Thanks to symmetrical construction and reversible hardware (handle, hinges) doors can be installed as right or left-handed.
- **Galvanized steel sheet, reinforced in three levels.**

EXTRA CHARGES

Polyester Paint - GROUP II

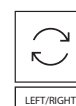

LEFT/RIGHT



70 - 90



GALVANIZED SHEET



Steel BASIC, Grey

Steel BASIC: The price of the internal door set includes:

- door leaf
- door frame
- door handle
- galvanized steel sheet construction

'Steel BASIC PLUS': The price of the external door set includes:

- door leaf
- door frame
- threshold
- door handle
- galvanized steel sheet construction



lock and handle



ventillation grille



powder paint coated threshold (SteelBASIC PLUS)



drip cap (Steel Basic PLUS)



honeycomb core



expanded polystyrene infill

Steel BASIC, Steel BASIC PLUS

AVAILABLE FINISHES

Galvanized steel sheet ♥♥♥♥◇◇



Coated steel sheet ♥♥♥♥◇◇



White

Grey

Anthracite

TECHNICAL INFORMATION

A DOOR SET INCLUDES

- a door leaf (steel sheet 0,5 mm, galvanized or galvanized and coated with a polyester paint)
- two standard barrel hinges
- cylinder lock
- a set of handles with escutcheons
- corner profile door frame (galvanized steel)
- a threshold (steel BASIC PLUS)
- a drip cap (steel BASIC PLUS) (see extra charges)

DOOR LEAF INCLUDES

- a door leaf (steel sheet 0,5 mm, galvanized or galvanized and coated with a polyester paint)
- two standard barrel hinges
- cylinder lock

DOOR FRAME

- A corner profile frame, profile 64 mm wide (like Corner profile - SMALL PLUS).
Made of 1,2 mm thick steel sheet, galvanized or powder paint coated.
- Steel BASIC door frame has a seal. Steel BASIC PLUS has a seal set circumferentially.
- Door frame- right or left, ready to be mounted on a finished floor level

NOTES

- **STEEL BASIC Norm PN EN 14351-2:2018-12, internal doors.**
- **Steel BASIC PLUS: PN-EN 14351-1+A1:2016 external doors.**
- Steel BASIC doors available only in 'investment norm' (see dimensions see p. 226, tab 4).
- Steel BASIC door leaf is produced in Polish norm and investment norm.
- Steel BASIC PLUS doors, inward opening, are equipped with a drip cap (see extra charges).
- **Due to the specifics of used material (coated steel), colours of the products are similar to colours of RAL pallette.**

EXTRA CHARGES

- ventilation grille (Steel BASIC)
- drip cap (Steel Basic PLUS)

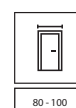

80 - 100



40 mm



GALVANIZED SHEET



Steel SOLID, solid, Grey



solid



model 1



model 2



model 3



model 4



model 5

INDICATIONS FOR USE:
 - designed for use in heavy-duty conditions
 - utility rooms
 - industrial premises
 - back offices
 - basements
 - garages
 - workshops
 - a barrier utility rooms
 - modern residential and office interiors (loft design)

PROTECTION SYSTEM OF STEEL SURFACES

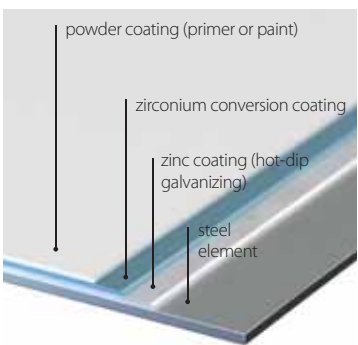

honeycomb core



expanded polystyrene infill

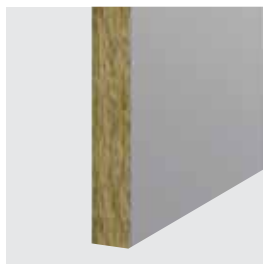

mineral wool infill

AVAILABLE FINISHES

Galvanized steel sheet ♥♥♥♥♥



Stainless steel ♥♥♥♥♥



Premium Polyester Paint ♥♥♥♥♥

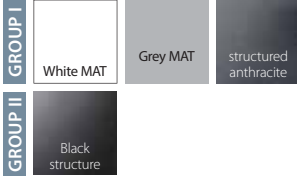

Laminated steel sheet (PVC) ♥♥♥♥♥

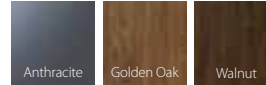

K Custom colours available through PORTA CONTRACT.

TECHNICAL INFORMATION

DOOR LEAF INCLUDES

- a door leaf (galvanized steel sheet 0,6 mm, powder paint coated)
- two standard barrel hinges (three hinges for size '100')
- cylinder lock
- frosted or transparent glass panel

SUGGESTED DOOR FRAMES

- Corner profile frame - SMALL PLUS, LARGE
- Steel ADJUSTABLE (standard), ADJUSTABLE 'PS' with 'sharp edges'
- PORTA SYSTEM steel door frame

NOTES

- Norm PN EN 14351-2:2018-12.
- **Door leaves with expanded polystyrene infill not available in polyester premium paint finish.**
- Door leaves skinned with laminated steel sheet - glazing available only with flat stainless steel glazing bead.
- Double doors are available in any door leaf size combinations.
- Double stainless steel door leaves are available only in PORTA CONTRACT offer.

EXTRA CHARGES

- size '100' (galvanized steel sheet door leaves)
 - size '100' (stainless steel door leaves)
 - Polyester Paint - GROUP II
 - Paint Anthracite structure, PVC sheet Anthracite
 - ventilation sleeves or grille (door leaves made of galvanized steel sheet)
 - stainless steel ventilation grille
 - reinforcement for a door closer
 - handle with an escutcheon
- contract option
(p. 217)

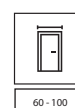



Steel EI 60 PLUS, double leaf, solid, model 3, Grey Matt



solid



model 2



model 3

■ EI 30 PLUS DOORS

are available in two types:

standard

- fire resistance 30 min

Type 1

- features of the Standard door type
- acoustic insulation class $R_w=32$ dB (32-36 dB)

■ EI 60 PLUS DOORS

are available in two types:

standard

- fire resistance 60 min.

Type 1 - single leaf door

- features of the Standard door type
- acoustic insulation class depending on the model $R_w=32$ dB (32-36 dB) or 37 dB (37-41 dB)*

Type 1 - double leaf doors

- features of the Standard door type
- sound insulation class $R_w=32$ dB (32-36 dB)*

* Detailed tests results are available at the manufacturer.

■ PROTECTION SYSTEM OF STEEL SURFACES

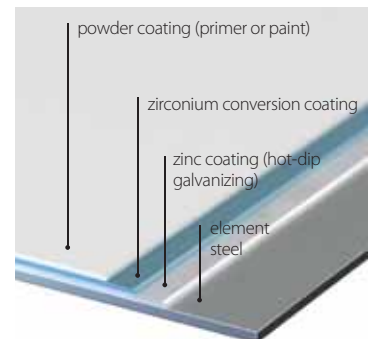

automatic shoot bolt



mortise cylinder lock, handle in the set



top/bottom lock bolt



intumescent seal

Steel EI 30 PLUS, EI 60 PLUS

AVAILABLE FINISHES

Premium Polyester Paint ♥♥♥♥♥

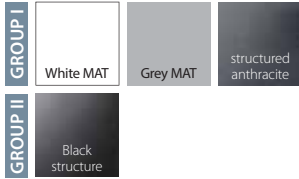

INDICATIONS FOR USE OF STEEL EI 30 AND EI 60 DOORS:

- public buildings
- hotels, guesthouses
- door to the boiler room
- garage door

K Custom colours available through PORTA CONTRACT.

TECHNICAL INFORMATION

ACCESSORIES INCLUDED IN THE DOOR LEAF PRICE

- 2 pieces of technical hinges. One is load-bearing, another, thanks to a spring in it, enables door to self-closing.
- a mortise cylinder lock
- two dog bolts
- a set of handles with escutcheons (order separately)
- transparent, fire proof glass panel

DOOR FRAMES

- Corner profile steel frame. Made out of both sides hot-dip galvanized steel, 1,5 mm thick. Welded joint of frame corners (single leaf doors) and folded door frame (double leaf doors). Equipped with astragal.
- A door frame can be ordered in two options:
- right or left door frame to install on a finished floor level - '0', threshold at an additional charge (EI 30 and EI 60).
- right or left door frame to install below a floor level - '-30', threshold at an additional charge (EI 30 and EI 60) Type 1 - frame equipped with threshold (105 mm) Type 1 - door frame equipped with a threshold (105 mm).

NOTES

- PN-EN 14351-2:2018-12 norm; PN-EN 16034:2014-11 norm.
- National Certificate of Constancy of Performance 020-UWB-2958/W.
- Unavailable sizes for single leaf doors: '90' - EI 60 model 3, '100' - EI 30, EI 60 model 2 and 3
- Unavailable sizes for double-leaf doors: -',80" - passive door leaf EI 60 model 3, '90" - passive door leaf EI 60 model 2, door leaf - Active and passive EI 60 model 3 and passive EI 30 model 3, '100" door leaf - Active and passive EI 30 and EI 60 model 2 and 3, passive door leaf EI 60 model solid
- In case of using different hardware to offered by PORTA, guarantee cards guidelines must be followed.

EXTRA CHARGES

- size '100' - EI 30, EI 60
- size '100' - EI 30, EI 60 - double leaf
- Polyester Paint - GROUP II
- reinforcement for a door closer

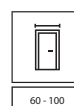

60 - 100



120 - 180

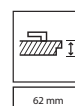

62 mm



GALVANIZED SHEET

DOOR FRAMES

12

→ One door leaf, a **lot of possibilities.**



PORTA VECTOR
model V
+ PORTA SYSTEM



PORTA VECTOR
model V
+ PORTA SYSTEM
ELEGANCE



PORTA VECTOR
model V
+ STEEL PORTA
SYSTEM ELEGANCE



PORTA VECTOR
model V
+ LEVEL

→ **Types of Porta** door frames



REBATED
WITH VISIBLE HINGES
MINIMAX, RENOVA, PORTA SYSTEM



NON-REBATED /
WITH REVERSED REBATED
WITH CONCEALED HINGES
see p. 190-193



NON-REBATED
**WITH RAISED
TOP PANEL**
LEVEL



STEEL HIGH DURABILITY
RESISTANT TO HUMIDITY
see p. 196-203

 **TIP!** Buy Conveniently as a set of door leaf + door frame + handle



MINIMAX

DOOR FRAME CROSS-SECTION



60 mm,
basic option
(without architraves)



100 mm,
synthetic Veneer
(architraves joined at 90° angle)
or Natural veneers (architrave-
joined at 45° angle)



100 mm,
synthetic Veneer
or Natural Veneer
(with rounded architraves)

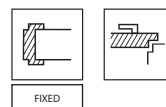

AVAILABLE FINISHES, colours samples see p. 234 – 241.



Portadecor
Portasynchro 3D



Portaperfect 3D
Natural Select
Natural Oak, Ash, Walnut
Oak Satin Veneer
Premium Lacquered Veneer



Portalamino
Matt Lacquered Veneer
Premium Plus UV Paint



CPL HQ 0.2 mm
Gladstone/Halifax

TECHNICAL INFORMATION

DOOR FRAME CONSTRUCTION

The door frame consists of:

- Door frame head and two jambs, made of MDF, with hardware and accessories,
- architraves (at additional charge)
- quarter round (at additional charge)

Door frame is produced and delivered as a set of elements to assemble on site. MINIMAX door frame for door leaves in Premium Plus UV Paint is finished with a priming film and painted with Premium Plus UV Paint.

ACCESSORIES- IN THE PRICE OF MINIMAX 60 MM

(available only in Portadecor and Portasynchro 3D finishes)

- two or three standard barrel hinges or PRIME hinges (optionally at extra charge)
- door stops
- dowel pins, hole plugs

ACCESSORIES- IN THE PRICE OF MINIMAX 100 MM

Synthetic veneers:

- two or three standard barrel hinges or PRIME hinges (optionally at extra charge)
- a rubber seal set circumferentially
- humidity protecting plugs for bottom part of a door frame

Natural veneers:

- three standard barrel hinges or PRIME hinges
- a rubber seal set circumferentially
- humidity protecting plugs for bottom part of a door frame

DOOR FRAME SIZE, SEE P. 224, TABLE 1

Profile width 60 mm and 100 mm.

„Available sizes '60', '70', '80', '90' and '100', and any combination of these sizes for double leaf doors

NOTES

- Technical Assessment ITB-KOT-2018/0358, issue 2.
- Door frame should be installed on finished walls (e.g. wall papers) and on a finished floor (e.g. floor panels).
- A door frame with a width of 100 mm can also be ordered as a 'tunnel' option (i.e. made without a rebate and without a seal, hinges and strike plate).
- Door frames and architraves are available in unpainted option (for self-finishing).
- Size '100' requires third hinge.
- Door frames, architraves and quarter rounds are also available in synthetic Veneer for self-painting. The price is the same as for door frames and architraves finished with Portadecor Veneer.

EXTRA CHARGES

door frame: CPL 0,2 mm finish - GROUP II
door frame: Natural Veneer: Natural Veneer, White Oak, Satin
door frame: Natural Veneer: Walnut
quarterround: Natural Veneer, White Oak, Satin
architraves: Natural Veneer, White Oak, Satin
PRIME hinges

DOOR FRAME CROSS-SECTION



ADJUSTMENT RANGE

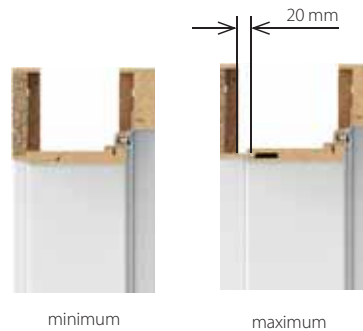
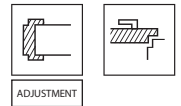

AVAILABLE FINISHES, colours samples see p. 234 – 241.



Portadecor
Portasynchro 3D



Portaperfect 3D
Premium Lacquered Veneer



Portalamino
Matt Lacquered Veneer



CPL HQ 0.2 mm

TECHNICAL INFORMATION

DOOR FRAME CONSTRUCTION

The door frame consists of:

- A door frame head and two jambs, made of wood-based materials
- Architraves

PORTA RENOVA is produced and delivered as a set of elements to assemble on site.

ACCESSORIES INCLUDED IN DOOR FRAME PRICE

- two or three standard barrel hinges

DOOR FRAME SIZE, SEE PAGE, 224, TABLE 1

For adjustment ranges ('S' + A-J) '60', '70', '80', '90', '100', '110'.

THE PORTA RENOVA OFFER INCLUDES:

- PORTA RENOVA door frame, adjustment range from 'A' to 'J' + size 'S' 55-75 mm 'tunnel' option, adjustment range from 'A' to 'J'.
- head and jambs with a tongue (broadening PORTA RENOVA adjustment) from 'A' to 'J'.

NOTES

- PN-EN 14351-2:2018-2 (only for the door set: Renova door frame and PORTA interior door leaf).
- Door frame should be installed on finished walls (e.g. wall papers) and on a finished floor (e.g. floor panels).
- The frame can also be ordered as the 'tunnel' option (i.e. made without the rebate, seal, hinges and lock catch).
- For widths '100' and '110', a third hinge is required.
- You can order additional broadening (head and jambs)
- The door frame is compatible with standard door leaves. If client chooses a handle wider than escutcheon wider than 44 mm, they have to order a door leaf with a 60 mm lock.
- **All crooks and unevenness of a wall and old door frame have to be taken into consideration during wall opening measurement.**
- **Due to the complicated installation, it is recommended to use the services of an Authorized Installation Group.**

PORTA SYSTEM, PORTA SYSTEM GK / GLASS

DOOR FRAME CROSS-SECTION



ADJUSTMENT RANGE

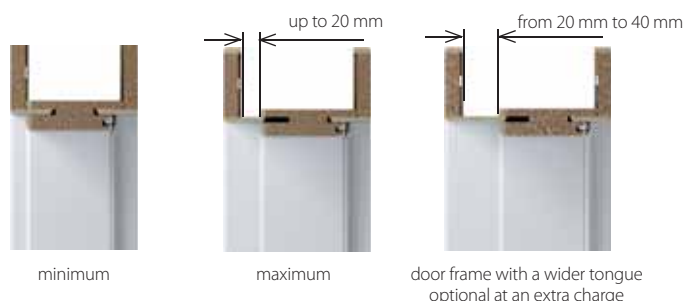

CROSS-SECTION / TOP VIEW

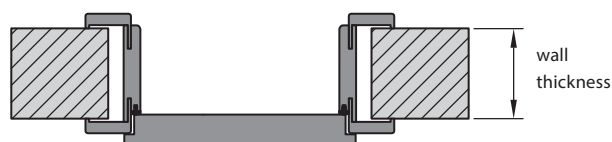

AVAILABLE FINISHES, colours samples see p. 234 – 241.

◆◆◆◆◆◆
Portadecor
Portasynchro 3D

◆◆◆◆◆◆
Portaperfect 3D
Premium Lacquered Veneer
Natural Select
Natural Oak, Walnut, Ash
Oak Satin Veneer

◆◆◆◆◆◆
Portalamino
Matt Lacquered Veneer
Premium Plus UV Paint

◆◆◆◆◆◆
CPL HQ 0.2 mm
Gladstone/Halifax

PAY ATTENTION TO DETAIL



PORTA SYSTEM, PORTA SYSTEM GK / GLASS

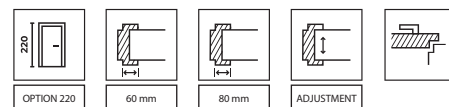

ADJUSTMENT RANGE

A	75 ÷ 95
BC	95 ÷ 115 120 ÷ 140
DE	140 ÷ 160 160 ÷ 180
FGH	180 ÷ 200 200 ÷ 220 220 ÷ 240
IJK	240 ÷ 260 260 ÷ 280 280 ÷ 300
LMN**	300 ÷ 320 320 ÷ 340 340 ÷ 360

** Range N is not available in UV Premium Plus Paint and Natural Veneers finishes

TECHNICAL INFORMATION

DOOR FRAME CONSTRUCTION

The door frame consists of:

- A door frame head and two jambs, made of wood-based material. It comes with hardware and accessories
- Architraves (60, 80 mm)

The door frame is produced and delivered as a set of elements to be assembled on site. PORTA SYSTEM door frame for door leaves in Premium Plus UV is covered with prime foli and finished with Premium Plus UV Paint.

ACCESSORIES INCLUDED IN DOOR FRAME PRICE

PORTA SYSTEM

Synthetic veneers:

- two or three standard barrel hinges or PRIME hinges (optionally at extra charge)
- a rubber seal set circumferentially

Natural Veneers:

- three standard barrel hinges or PRIME hinges
- a rubber seal set circumferentially

PORTA SYSTEM GK/GLASS

A strike plate (small)

- a rubber seal set circumferentially
- hinge receivers, 2 PCs for size '60'-'90'; 3 PCs for size '100'

NOTE! Hinges are not included in a door frame set.

DOOR FRAME SIZE, SEE P. 224, TABLE 1

PORTA SYSTEM

- Wall thicknesses (A-K) '60'; '70'; '80'; '90'; '100'; '110'; and '120'-'200' and single leaf '60'-'90' with a side panel '40'*.¹

PORTA SYSTEM GK/GLASS

- Wall thicknesses (A-K) '60'; '70'; '80'; '90'

NOTES

- Technical Assessment ITB-KOT-2018/0358, issue 2.
- Door frame should be installed on finished walls (e.g. wall papers) and on a finished floor (e.g. floor panels).
- The door frame is also available in a 'tunnel' option (without a rebate, a seal, hinges or a strike plate). Available up to the K range. Larger dimension can be achieved by using the Adjustment Panel.
- Size '100' requires third hinge
- Height '220' finishes - Premium lacquered Veneer, Premium Plus UV Paint, Natural Veneer, three hinges as a standard
- Investment set is available for finishes: CPL, Portalamino and Natural Veneer.
- Range M finished with Premium Plus UV Paint and with Natural veneers consists of beam for L range and architrave with long tongue.
- The door frames are also available in synthetic Veneer for self-painting - the price is the same as the price of door frames in Portadecor.

EXTRA CHARGES

door frame 220 Premium UV Paint

door frame 220 Premium Plus UV Paint, Natural Veneer

door frame: CPL 0,2 mm finish - GROUP II

door frame: Natural Veneer: Walnut

door frame: Natural Veneer: Black, White Oak, Satin

architrave with wide tongue: synthetic veneers

architrave with wide tongue: Premium Plus UV Paint

architrave with wide tongue: natural veneers

PRIME hinges

electric strike: fail-secure or fail safe

investment set

reinforcement for a door closer

(p.220)

¹Applies only to door frame in Natural Veneer

PORTA SYSTEM ELEGANCE, PORTA SYSTEM ELEGANCE 90 deg.

DOOR FRAME CROSS-SECTION PORTA SYSTEM ELEGANCE



ADJUSTMENT RANGE

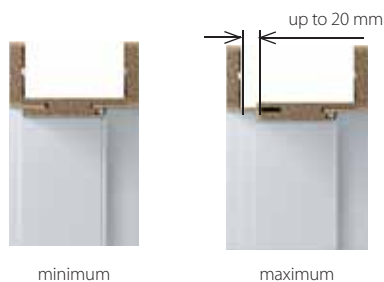

ARCHITRAVES JOINING PORTA SYSTEM ELEGANCE 90 degrees



Illustrative drawings



Flush surface.
Door frame finished with synthetic Veneer.



Main beam recessed.
Door frame finished with Premium Plus UV Paint



Flush surface.
Door frame finished with Natural Veneer.

PAY ATTENTION TO DETAIL



rebate at an even level with
a door frame



concealed 3D hinge

KEY FEATURES OF THE 3D HINGE:

- Possibility of adjustment in three planes 3D
- Perfect performance
- The visible part of the hinge finished with a durable polyester coating in the colour of your choice.

PORTA SYSTEM ELEGANCE, PORTA SYSTEM ELEGANCE 90 deg.

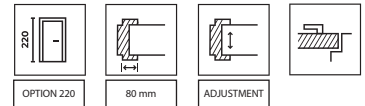

PORTA SYSTEM ELEGANCE ADJUSTMENT RANGES

	95 ÷ 115 120 ÷ 140
DE	140 ÷ 160 160 ÷ 180
FGH	180 ÷ 200 200 ÷ 220 220 ÷ 240
IJK	240 ÷ 260 260 ÷ 280 280 ÷ 300
LMN*	300 ÷ 320 320 ÷ 340 340 ÷ 360

* Range N not available in UV Paint Premium Plus and Natural Veneers finishes

PORTA SYSTEM ELEGANCE 90 degrees ADJUSTMENT RANGES

BC	95 ÷ 115 120 ÷ 140
DE	140 ÷ 160 160 ÷ 180
FGH	180 ÷ 200 200 ÷ 220 220 ÷ 240
IJK	240 ÷ 260 260 ÷ 280 280 ÷ 300

AVAILABLE FINISHES, colours samples see p. 234 – 241.



Portadecor
Portasynchro 3D



Portaperfect 3D
Premium Lacquered Veneer
Natural Select
Natural Oak, Walnut, Ash
Oak Satin Veneer



Portalamino
Matt Lacquered Veneer
Premium Plus UV Paint



CPL HQ 0.2 mm
Gladstone/Halifax

TECHNICAL INFORMATION

DOOR FRAME CONSTRUCTION

The door frame consists of:

- A door frame head and two jambs, made of wood-based material. It comes with hardware and accessories.

Architraves 80 mm.

Architrave edge radius, aris, for Natural veneers

Architrave edge radius 1,5 mm for synthetic finishes: Portadecor, Portasynchro 3D,

Portaperfect 3D and Premium lacquered Veneer 3mm radius for CPL HQ 0,2 mm.

PS ELEGANCE is produced and delivered as a set of elements to assemble on site.

PS ELEGANCE door frame for door leaves in Premium Plus UV is covered with prime foil and finished with Premium plus UV Paint.

ACCESSORIES INCLUDED IN DOOR FRAME PRICE

- two sets of 3D adjustable hinges
- a rubber seal set circumferentially

DOOR FRAME SIZE

- Ten adjustment ranges from 95 mm to 300 mm; '60'; '70'; '80'; '90'; '100'; and '120'-'200'.

NOTES

- Technical Assessment ITB-KOT-2018/0358, issue 2.
- Door frame should be installed on finished walls (e.g. wall papers) and on a finished floor (e.g. floor panels).
- The door frame is also available in a 'tunnel' option (without a rebate, a seal, hinges or a strike plate) (it regards PS ELEGANCE).

- Height 220 cm is available in following finishes: Premium lacquered Veneer, Premium Plus UV Paint, Natural Veneer. Three hinges as a standard.

- Range M finished with Premium Plus UV Paint and with Natural veneers consists of beam for L range and architrave with long tongue.

- The door frames are also available in synthetic Veneer for self-painting - the price is the same as the price of door frames in Portadecor.

EXTRA CHARGES

door frame 220 Premium UV Paint and Portadecor Fiord Veneer

door frame 220 Premium Plus UV Paint, Natural Veneer

architraves 100 mm (apply to height 220 cm, PS ELEGANCE finished with Natural Veneer)

door frame: CPL 0,2 mm finish - GROUP II (applies to PS ELEGANCE)

door frame: Natural Veneer: Walnut

door frame: Natural Veneer: Black, White Oak, Satin

architrave with wide tongue: synthetic veneers

architrave with wide tongue: Premium Plus UV Paint

architrave with wide tongue: natural veneers

gold 3D hinges (extra charge added to a door frame price)

third 3D hinge - gold (extra charge added to door frame price)

third 3D hinge - silver, white, black (extra charge added to a door frame price)

magnetic strike plate (for LUMIA)

reinforcement for a door closer (applies to PS ELEGANCE)

PORTA SYSTEM with reversed rebate

DOOR FRAME CROSS-SECTION



ADJUSTMENT RANGE

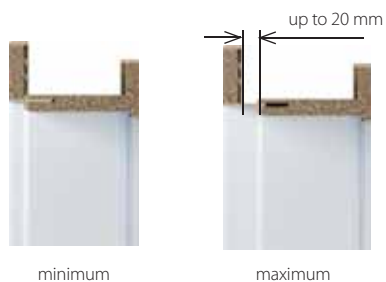

DOOR OPENING DIRECTION

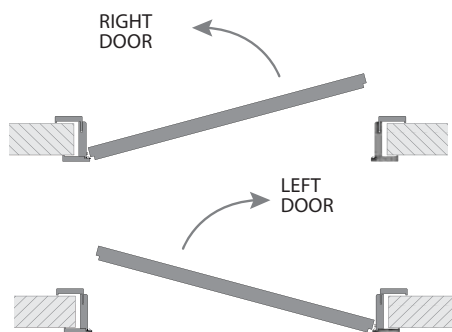

PAY ATTENTION TO DETAIL



rebate at an even level with a door frame



concealed, dedicated 3D hinge

KEY FEATURES OF THE 3D HINGE:

- Possibility of adjustment in three planes 3D
- Perfect performance
- The visible part of the hinge finished with a durable polyester coating in the colour of your choice.

PORTA SYSTEM with reversed rebate

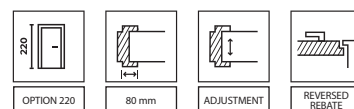

ADJUSTMENT RANGE

BC	95 ÷ 115 120 ÷ 140
DE	140 ÷ 160 160 ÷ 180
FGH	180 ÷ 200 200 ÷ 220 220 ÷ 240
IJK	240 ÷ 260 260 ÷ 280 280 ÷ 300

AVAILABLE FINISHES, colours samples see p. 234 – 241.



Premium Lacquered Veneer
Natural Select
Natural Oak, Ash, Walnut
Oak Satin Veneer



Premium Plus UV Paint

TECHNICAL INFORMATION

DOOR FRAME CONSTRUCTION

The door frame consists of:

- A door frame head and two jambs, made of wood-based material. It comes with hardware and accessories.
 - Architraves 80 mm on both sides.
- Architrave edge radius, aris', for Natural veneers Standard, Select, Satin.
Architrave edge radius 1,5 mm for Lacquered premium Veneer and Premium Plus UV Paint. The door frame is manufactured and delivered to the customer as a set of components to be installed on site.

APPLICATION

- PORTA SYSTEM door frame with reversed rebate is available in collections:
- painted collections: PORTA VECTOR Premium, PORTA DESIRE, PORTA FOCUS Premium, PORTA GRANDE, PORTA ART DECO, PORTA OSLO
 - collections in Natural Veneer: Nature CLASSIC, Nature GRANDE, Nature LINE, Nature OSLO

ACCESSORIES INCLUDED IN DOOR FRAME PRICE

- two sets of 3D adjustable hinges
- a rubber seal set circumferentially

DOOR FRAME SIZE

- Ten adjustment ranges from 95 mm to 300 mm; '60', '70', '80', '90', '100'.

NOTES

- Technical Assessment ITB-KOT-2018/0358, issue 2.
- Door frame should be installed on finished walls (e.g. wall papers) and on a finished floor (e.g. floor panels).
- **Height '220' - three hinges as standard.**

EXTRA CHARGES

- door frame 220 Premium UV Paint
- door frame 220 Premium Plus UV Paint, Natural Veneer
- door frame: Natural Veneer: Walnut
- door frame: Natural Veneer: Black, White Oak, Satin
- third 3D hinge - silver
- third 3D hinge, white and black
- gold 3D hinges
- third 3D hinge - gold

LEVEL

DOOR FRAME CROSS-SECTION

Cut to size yourself to fit the needed height.

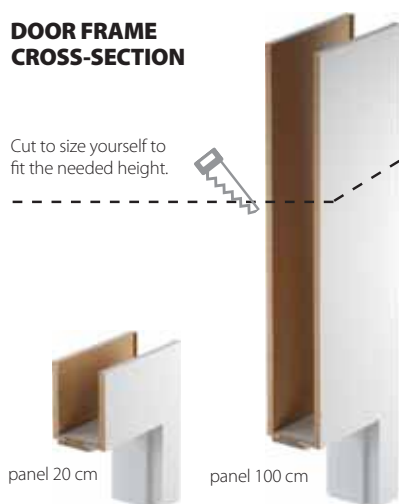

ADJUSTMENT RANGE

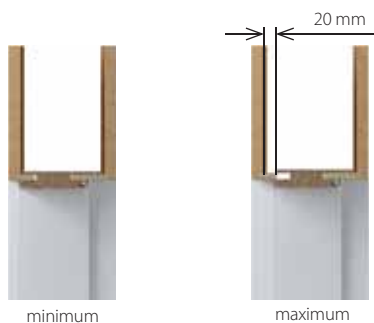

NOTE: if the hinge socket does not fit into the wall opening, please make forging as in the picture p. 233

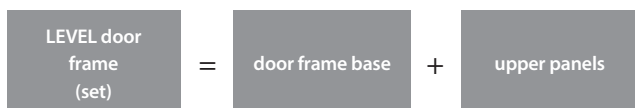

PAY ATTENTION TO DETAIL

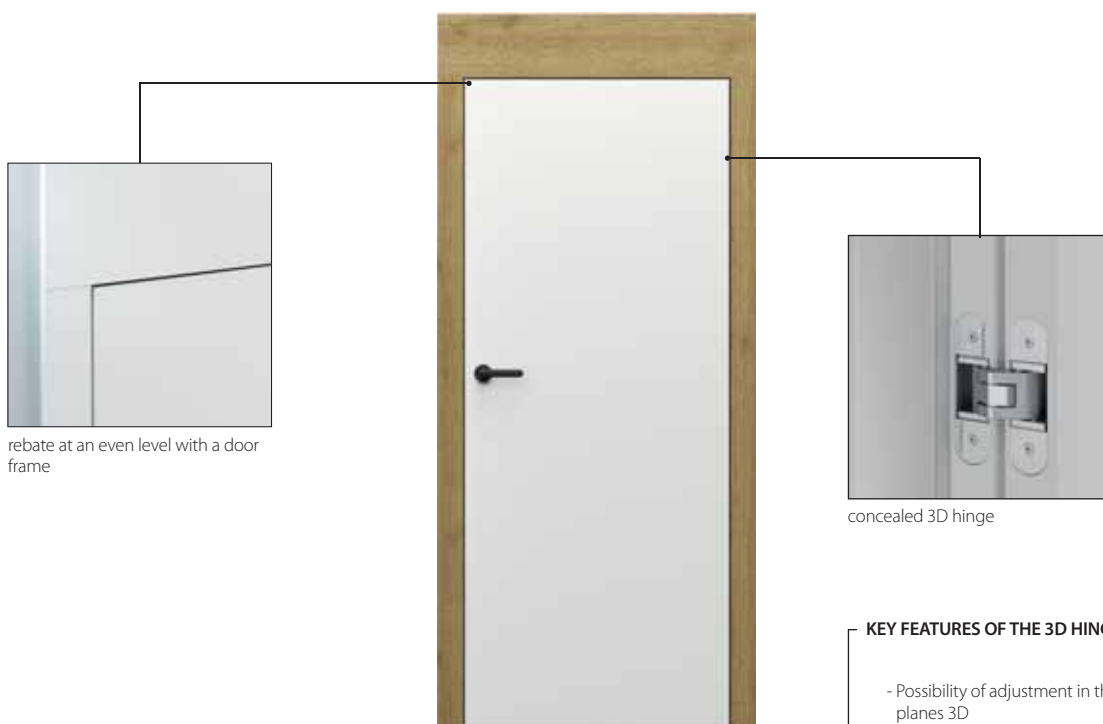

KEY FEATURES OF THE 3D HINGE:

- Possibility of adjustment in three planes 3D
- Perfect performance
- The visible part of the hinge finished with a durable polyester coating in the colour of your choice.

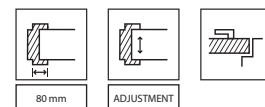

ADJUSTMENT RANGE

BC	95 ÷ 115 120 ÷ 140
DE	140 ÷ 160 160 ÷ 180
FGH	180 ÷ 200 200 ÷ 220 220 ÷ 240
IJK	240 ÷ 260 260 ÷ 280 280 ÷ 300

UPPER PANELS

200 mm (2x)

1000 mm (2x)

200 and 1000 mm (1/1)

AVAILABLE FINISHES, colours samples see p. 234 – 241.



Portadecor
Portasynchro 3D



Portaperfect 3D
Premium Lacquered Veneer



Portalamino
Premium Plus UV Paint

TECHNICAL INFORMATION

DOOR FRAME CONSTRUCTION

The door frame consists of:

- A door frame head and two jambs, made of wood-based material. It comes with hardware and accessories, architraves 80 mm two vertical panels (order separately).

Vertical grain direction for a LEVEL panel. For chosen finishes horizontal grain direction available (see p. 95).

Architrave edge radius - 1,5 mm. LEVEL door frame is produced and delivered as a set of elements to be assembled on site.

LEVEL door frame for door leaves in Premium Plus UV Paint is covered with prime Paint and finished with Premium plus UV Paint.

ACCESSORIES INCLUDED IN THE DOOR FRAME PRICE

- two sets of 3D adjustable hinges
- a rubber seal set circumferentially

DOOR FRAME SIZE, SEE PAGE, 224, TABLE 1

Ten adjustment ranges from 95 mm to 300 mm;
'60'; '70'; '80'; '90'; '100'

NOTES

- Technical Assessment ITB-KOT-2018/0358, issue 2.
- Door frame should be installed on finished walls (e.g. wall papers) and on a finished floor (e.g. floor panels).
- Door frame is also available in a 'tunnel' option (without a rebate, a seal, hinges or a strike plate).

EXTRA CHARGES

- gold 3D hinges (extra charge added to a door frame price)
- third 3D hinge - gold (extra charge added to door frame price)
- third 3D hinge - silver, white, black (extra charge added to a door frame price)

Corner profile - LARGE BASIC

Adjustable BASIC

Corner profile - LARGE BASIC

DOOR FRAME CROSS-SECTION



CROSS-SECTION OF CORNER PROFILE STEEL DOOR FRAME - LARGE BASIC

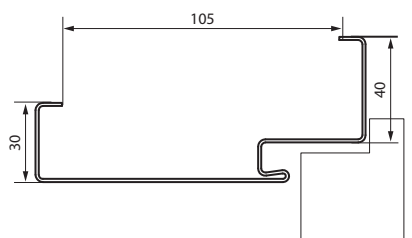

Adjustable steel BASIC

DOOR FRAME CROSS-SECTION



ADJUSTMENT OF ADJUSTABLE BASIC door frame

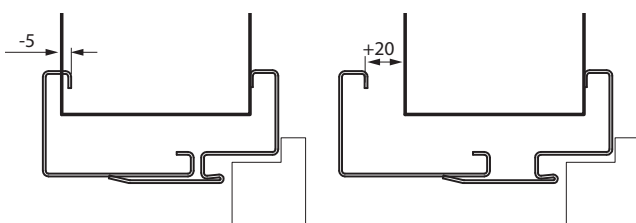

ADJUSTMENT RANGES OF ADJUSTABLE BASIC door frame

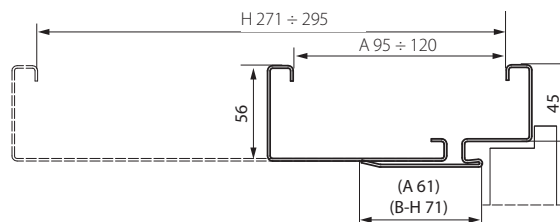

AVAILABLE FINISHES, colours samples see p. 234 – 241.

Premium Polyester Paint ♥♥♥♥◇◇

GROUP I	White MATT	Grey MATT	structured anthracite	GROUP II	Black black
	Anthracite HPL/CPL	Beige MAT	Brown MAT		GROUP III

Primer Paint ♥♥♥♥◇◇



Corner profile - LARGE BASIC

Adjustable BASIC

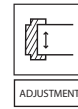

ADJUSTMENT



FOR CONSTRUCTION AND DOOR FRAME COATING

ADJUSTABLE BASIC

ADJUSTMENT RANGE

A	95 ÷ 120 mm
B	121 ÷ 145 mm
C	146 ÷ 170 mm
D	171 ÷ 195 mm
E	196 ÷ 220 mm
F	221 ÷ 245 mm
G	246 ÷ 270 mm
H	271 ÷ 295 mm

TECHNICAL INFORMATION

DOOR FRAME CONSTRUCTION

Products made of 1.2 mm thick DC01 carbon steel, powder paint coated.
Corner profile steel door frame - LARGE BASIC - profile width 105 mm.

In two options:

To be installed on a finished floor level - '0'

To be installed under floor level - '-30'

Adjustable steel door frame BASIC consists of:

fixed part mounted on a wall (with hinges and lock strike), permanently attached to the wall
adjustable part, wrapping the wall
- A rubber seal set circumferentially
barrel hinges

ACCESSORIES INCLUDED IN THE DOOR FRAME PRICE

Corner profile steel door frame - LARGE BASIC for masonry walls

- two or three standard barrel hinges

- three hinges (size '100' and '110')

- a rubber seal set circumferentially

Corner profile - LARGE BASIC for plasterboard walls

- two or three standard barrel hinges

- three hinges (size '100' and '110')

- a rubber seal set circumferentially

- special anchors for plasterboard walls for easy installation (up to a maximum wall width of 150 mm)

Adjustable steel BASIC

- two or three standard barrel hinges

- three hinges (size '100' and '110')

- rubber seal set circumferentially, white, grey, brown, cream, anthracite, black

- raw/plugs - for a door frame anchored to a concrete wall

- self-tapping screws - for a door frame anchored to a plasterboard wall

NOTES

- Technical Assessment ITB-KOT-2017/0245 issue 2.

- Certificate of conformity no. 0004/W, ITB Warsaw.

- Polyester Premium Paint Anthracite HPL/CPL is dedicated for door leaves finished with HPL/CPL Anthracite.

- Size '80' and '90' in the 'Investment Norm' (clear opening width 800, 900 mm) available as a standard - without an extra charge.

EXTRA CHARGES

Polyester Paint - GROUP II

third 3D hinge - gold (extra charge added to door frame price)

third 3D hinge - silver, white, black (extra charge added to a door frame price)

dowel pins (LARGE)

adjustable lock strike (LARGE)

electric strike: fail-secure or fail safe

(p.220)

extension of the door frame profile from 110 to 150 mm

extension of the door frame profile from 155 to 270 mm

extension of the door frame profile from 275 to 390 mm

investment set

production with use of 1,5 mm galvanized steel (4th strength performance class)

reinforcement for a door closer

stainless steel threshold

(p.220)

* accessories and extra charge applies to Corner profile door frames - SMALL PLUS AND LARGE.

Steel PORTA SYSTEM ELEGANCE

Steel W SYSTEM

Steel Porta SYSTEM

DOOR FRAME CROSS-SECTION



ADJUSTMENT RANGES OF A DOOR FRAME

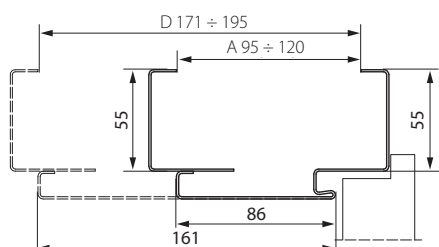

DOOR FRAME ADJUSTMENT

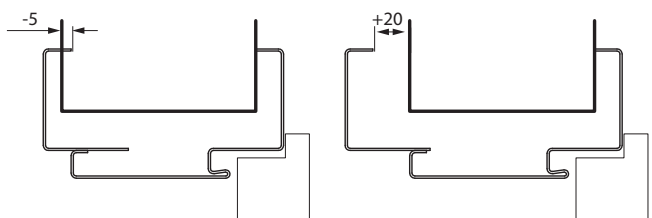

Steel Porta SYSTEM ELEGANCE

DOOR FRAME CROSS-SECTION



ADJUSTMENT RANGES OF A DOOR FRAME

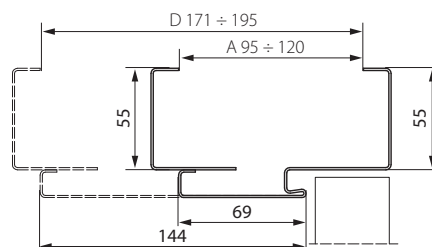

DOOR FRAME ADJUSTMENT

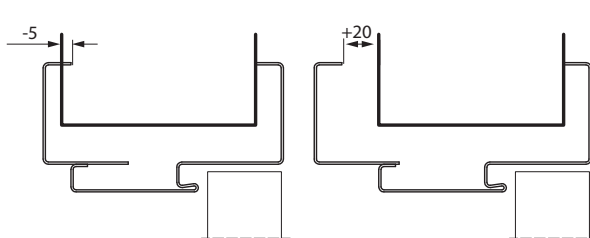

AVAILABLE FINISHES, colours samples see p. 234 – 241.

Premium Polyester Paint ♥♥♥♥♥

GROUP I	White MATT	Grey MATT	structured anthracite	GROUP II	Black black
	Anthracite HPL/CPL	Beige MAT	Brown MAT		GROUP III

Steel PORTA SYSTEM ELEGANCE

Steel PORTA SYSTEM



OPTION 220



ADJUSTMENT



FOR CONSTRUCTION AND DOOR FRAME COATING

Steel Porta SYSTEM

ADJUSTMENT RANGE

A	95 ÷ 120 mm
B	121 ÷ 145 mm
C	146 ÷ 170 mm
D	171 ÷ 195 mm

Steel Porta SYSTEM ELEGANCE

ADJUSTMENT RANGE

A	95 ÷ 120 mm
B	121 ÷ 145 mm
C	146 ÷ 170 mm
D	171 ÷ 195 mm

TECHNICAL INFORMATION

DOOR FRAME CONSTRUCTION

This adjustable door frame is made out of the best quality galvanized steel, 1,2 mm thick.

The door frame consists of:

- fixed part mounted on a wall (with necessary accessories)
- adjustable part, wrapping the wall -5, +20 mm
- rubber seal
- standard barrel hinges (steel PORTA SYSTEM)
- adjustable 3D hinges (steel PORTA SYSTEM ELEGANCE)

ACCESSORIES INCLUDED IN THE DOOR FRAME PRICE

- two or three standard barrel hinges (steel PORTA SYSTEM)
- two adjustable 3D hinges (steel PORTA SYSTEM ELEGANCE)
- three hinges (for door frame '100') (PORTA SYSTEM steel door frame)
- rubber seal set circumferentially, white, grey, brown, cream, anthracite, black
- fixed part mounted on a wall
- reinforcement for the lock strike*

DOOR FRAME SIZE SEE P. 225, TABLE 3

- "60", "70", "80", "90", "100" i "120" ÷ "200"
To be installed on a finished floor level '0'.

NOTES

- Technical Assessment ITB-KOT-2017/0245 issue 2.
- Certificate of conformity no. 0004/W, ITB Warsaw.
- Door frame should be installed on finished walls (e.g. wall papers) and on a finished floor (e.g. floor panels).
- Premium Anthracite HPL/CPL Polyester Paint is dedicated to be in set with for door leaves finished with in HPL/CPL Anthracite.
- Size '80' and '90' in the 'Investment Norm' (clear opening width 804, 904 mm) available as a standard - without extra charge.

EXTRA CHARGES

door frame 220
Polyester Paint - GROUP II
third 3D hinge - gold (extra charge added to door frame price)
third 3D hinge - silver, white, black (extra charge added to a door frame price)
adjustable lock strike*
investment set
production with use of 1,5 mm galvanized steel (4th strength performance class)
reinforcement for a door closer

*accessories and extra charge applies to steel PORTA SYSTEM

Adjustable, non-rebated, Adjustable, Adjustable PS 'with sharp edges'

Steel Adjustable

DOOR FRAME CROSS-SECTION



ADJUSTMENT RANGES OF A DOOR FRAME

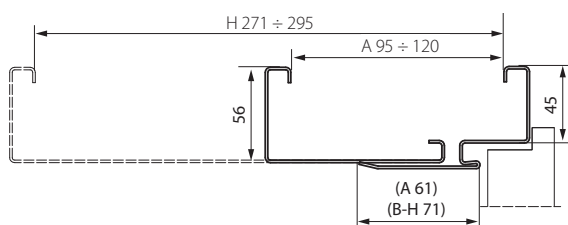

HOW TO ADJUST THE DOOR FRAME

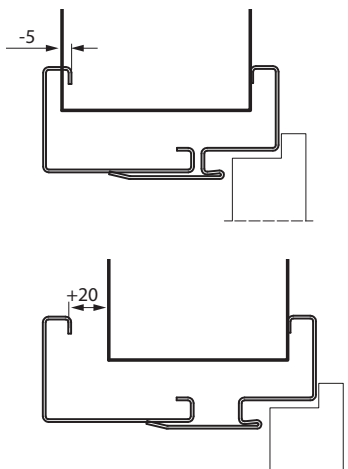

Steel, adjustable, non-rebated

DOOR FRAME CROSS-SECTION



ADJUSTABLE STEEL DOOR FRAME, NON-REBATED - ADJUSTMENT RANGES

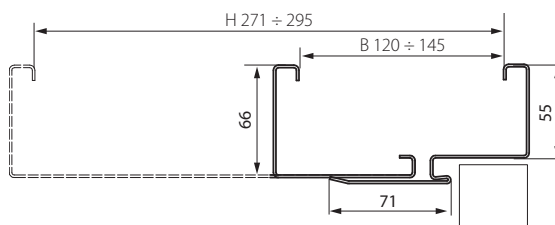

HOW TO ADJUST ADJUSTABLE NON-REBATED DOOR FRAME

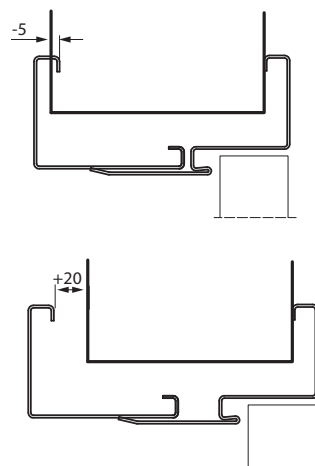

Steel PS 'with sharp edges'

DOOR FRAME WCROSS-SECTION



AVAILABLE FINISHES, colours samples see p. 234 - 241.

Premium Polyester Paint ♥♥♥♥♥

GROUP I	White MAT	Gray MAT	structured anthracite	GROUP II	Black structure
	Anthracite HPL/CPL	Beige MAT	Brown MAT		GROUP III

Adjustable, steel, non-rebated, Adjustable, Adjustable PS 'with sharp edges'

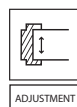

ADJUSTMENT



GALVANIZED SHEET



ADJUSTMENT RANGE

A	95 ÷ 120 mm
B	121 ÷ 145 mm
C	146 ÷ 170 mm
D	171 ÷ 195 mm
E	196 ÷ 220 mm
F	221 ÷ 245 mm
G	246 ÷ 270 mm
H	271 ÷ 295 mm

ADJUSTMENT RANGE

B	120 ÷ 145 mm
C	146 ÷ 170 mm
D	171 ÷ 195 mm
E	196 ÷ 220 mm
F	221 ÷ 245 mm
G	246 ÷ 270 mm
H	271 ÷ 295 mm

TECHNICAL INFORMATION

DOOR FRAME CONSTRUCTION

The adjustable door frame is made out of the best quality galvanized steel, 1,5 mm thick (the Adjustable, Adjustable non-rebated) or 1,2 mm thick (the Adjustable with 'sharp edges').

The door frame consists of:

- fixed part mounted on a wall (with hinges and lock strike)
- adjustable part, wrapping the wall
- A rubber seal set circumferentially
- barrel hinges (rebated door frames)
- adjustable 3D hinges (adjustable non-rebated door frame)

ACCESSORIES INCLUDED IN THE DOOR FRAME PRICE

- two or three standard barrel hinges (ADJUSTABLE frame)
- three hinges (size '100' and '110') (ADJUSTABLE frame)
- two adjustable 3D hinges (ADJUSTABLE NON-REBATED frame)
- rubber seal set circumferentially, white, grey, brown, cream, anthracite, black
- rawlplugs - for a door frame anchored to a concrete wall
- self-tapping screws - for a door frame anchored to a plasterboard wall

DOOR FRAME SIZE, SEE PAGE, 225, TABLE 3

- '60', '70', '80', '90', '100', '110' and '120' ÷ '200'
- To be installed on a finished floor level '0'.

NOTES

- Technical Assessment ITB-KOT-2017/0245 issue 2.
- Certificate of conformity no. 0004/W, ITB Warsaw.
- Door frame should be installed on finished walls (e.g. wall papers) and on a finished floor (e.g. floor panels).
- Premium Anthracite HPL/CPL Polyester Paint is dedicated to be in set with for door leaves finished with in HPL/CPL Anthracite.
- Size '80' and '90' in the 'Investment Norm' (clear opening width 804, 904 mm) available as a standard - without extra charge.

EXTRA CHARGES

- Polyester Paint - GROUP II
- third 3D hinge - gold (extra charge added to door frame price)
- third 3D hinge - silver, white, black (extra charge added to a door frame price)
- adjustable lock strike*
- electric strike: fail-secure or fail safe (p.220)
- investment set
- reinforcement for a door closer
- production with use of 1,5 mm galvanized steel (4th strength performance class)
- stainless steel threshold (p.220)

* accessories and extra charge applies to adjustable Steel door frame and adjustable PS with 'sharp edges'

Corner profile Non-rebated, Steel - LARGE

Corner profile - SMALL PLUS, LARGE

Corner profile - SMALL PLUS

DOOR FRAME CROSS-SECTION



DOOR FRAME CROSS-SECTION

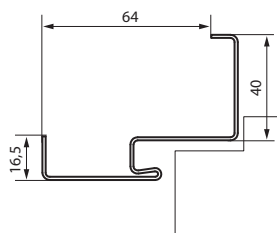

Corner profile - LARGE

DOOR FRAME CROSS-SECTION



DOOR FRAME CROSS-SECTION

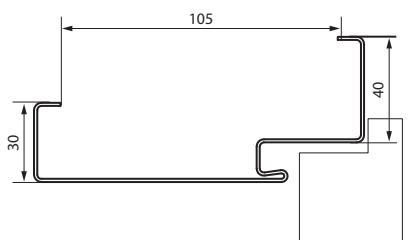

Corner profile - LARGE, non-rebated

DOOR FRAME CROSS-SECTION



DOOR FRAME CROSS-SECTION

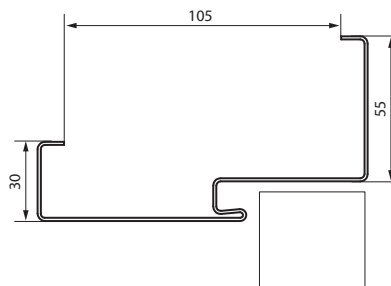

AVAILABLE FINISHES, colours samples see p. 234 – 241.

Premium Polyester Paint ♥♥♥♥♥

GROUP I	White MAT	Grey MAT	structured anthracite	GROUP II	Black black
	Anthracite HPL/CPL	Beige MAT	Brown MAT		GROUP III

Corner profile Non-rebated, Steel - LARGE

Corner profile - SMALL PLUS, LARGE



FOR CONSTRUCTION AND DOOR FRAME COATING

TECHNICAL INFORMATION

DOOR FRAME CONSTRUCTION

Corner profile door frames (LARGE, SMALL PLUS and Non-rebated - LARGE) are made out of galvanized steel, 1,2 mm thick. They are available as reversible* door frames or as right/left door frames. Profile width: 64 mm (SMALL PLUS) and 105 mm (LARGE, Non-rebated LARGE).

ACCESSORIES INCLUDED IN THE DOOR FRAME PRICE

'LARGE', 'SMALL PLUS'

- two or three standard barrel hinges
- three hinges (size '100' and '110')
- a rubber seal set circumferentially. Colours: white, grey, brown, beige, anthracite and black
- special anchors to ease an installation (SMALL PLUS)

'LARGE' for plasterboard walls:

- two or three standard barrel hinges
- three hinges (size '100' and '110')
- a rubber seal available in following colours: white, grey, brown, beige, anthracite and black
- special anchors for plasterboard walls for easy installation (up to a maximum wall width of 150 mm)

Non-rebated, LARGE'

- two 3D adjustable hinges
- a rubber seal set circumferentially. Colours: white, grey, brown, beige, anthracite and black

DOOR FRAME SIZE, SEE PAGE, 225, TABLE 3

- '60', '70', '80', '90', '100', '110' and '120' ÷ '200'

In two options:

- To be installed on a finished floor level - '0'
- To be installed under floor level - '-30'

NOTES

- National - Technical Assessment ITB-KOT-2017/0245 2nd edition.
- Certificate of conformity no. 0004/W, ITB Warsaw.
- Premium Anthracite HPL/CPL Polyester Paint is dedicated to be in set with for door leaves finished with in HPL/CPL Anthracite.

EXTRA CHARGES

- Polyester Paint - GROUP II
- third 3D hinge - gold (extra charge added to door frame price)
- third 3D hinge - silver, white, black (extra charge added to a door frame price)
- dowel pins (LARGE)
- adjustable lock strike (LARGE)
- electric strike: fail-secure or fail safe (p.220)
- extension of the door frame profile from 110 to 150 mm
- extension of the door frame profile from 155 to 270 mm
- extension of the door frame profile from 275 to 390 mm
- investment set
- production with use of 1,5 mm galvanized steel (4th strength performance class)
- reinforcement for a door closer
- stainless steel threshold (p.220)

* accessories and extra charge applies to Corner profile door frames - wSMALL PLUS AND LARGE

PROJECT BIS, PROJECT Premium®

® PORTA proprietary solution, all rights reserved

DOOR FRAME CROSS-SECTION



PROJECT BIS DOOR FRAME



PROJECT PREMIUM door frame

AVAILABLE FINISHES, colours samples see p. 234 – 241.

▼▼▼▼▼▼
Portasynchro 3D

▼▼▼▼▼▼
Portaperfect 3D

▼▼▼▼▼▼
Portalamino

▼▼▼▼▼▼
CPL HQ 0.2 mm
Gladstone/Halifax

DRAWINGS (ILLUSTRATIVE)

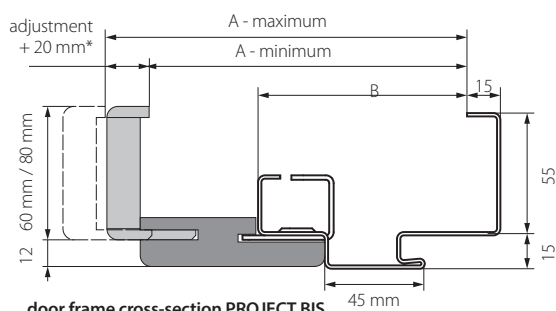

door frame cross-section PROJECT BIS

* for range A adjustment of +15 mm

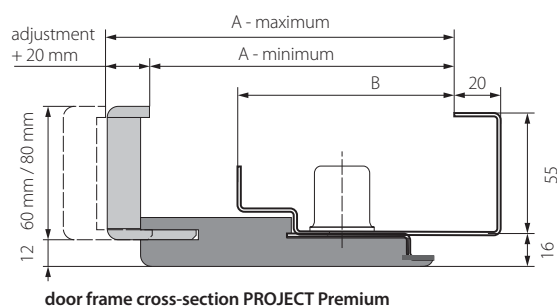

door frame cross-section PROJECT Premium

ADJUSTMENT RANGES

MODELS	PROJECT BIS		PROJECT PREMIUM	
	A	B	A	B
Rw=27 dB	138 ÷ 363 mm	89 mm	133 ÷ 333 mm	95 mm
Rw=32 dB	138 ÷ 363 mm	89 mm	133 ÷ 333 mm	95 mm
AGATE, OPAL	138 ÷ 363 mm	89 mm	133 ÷ 333 mm	95 mm
QUARTZ	138 ÷ 363 mm	89 mm	133 ÷ 333 mm	95 mm
Granite cl. C	143 ÷ 368 mm	94 mm	138 ÷ 338 mm	100 mm
El 30	143 ÷ 368 mm	94 mm	138 ÷ 338 mm	100 mm
Extreme RC 2, RC 3	147 ÷ 372 mm	98 mm	142 ÷ 342 mm	104 mm
Extreme RC 4	152 ÷ 372 mm	103 mm	147 ÷ 347 mm	109 mm
Silence 37 dB, rebated	147 ÷ 372 mm	98 mm	142 ÷ 342 mm	104 mm
Silence 37 dB, non-rebated	164 ÷ 389 mm	115 mm	159 ÷ 359 mm	121 mm
Rw=42 dB	162 ÷ 387 mm	113 mm	157 ÷ 357 mm	119 mm
El 60	155 ÷ 380 mm	106 mm	-	-

PROJECT BIS, PROJECT Premium®

® PORTA proprietary solution, all rights reserved

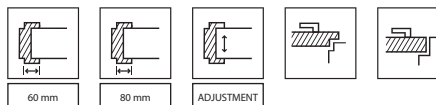

FOR CONSTRUCTION AND DOOR FRAME COATING

PROJECT BIS COVER *

	AGAT, OPAL, QUARTZ 27 dB, 32 dB	GRANIT, EI 30	Silence 37 dB rebated, EXTREME RC2 and RC3	EXTREME RC4	SILENCE 37 dB non-rebated	Rw = 42 dB	EI 60
A	138 ÷ 153 mm	143 ÷ 158 mm	147 ÷ 162 mm	152 ÷ 167 mm	164 ÷ 179 mm	162 ÷ 177 mm	155 ÷ 170 mm
B	158 ÷ 178 mm	163 ÷ 183 mm	167 ÷ 187 mm	172 ÷ 192 mm	184 ÷ 204 mm	182 ÷ 202 mm	175 ÷ 195 mm
C	183 ÷ 203 mm	188 ÷ 208 mm	192 ÷ 212 mm	197 ÷ 217 mm	209 ÷ 229 mm	207 ÷ 227 mm	200 ÷ 220 mm
D	203 ÷ 223 mm	208 ÷ 228 mm	212 ÷ 232 mm	217 ÷ 237 mm	229 ÷ 249 mm	227 ÷ 247 mm	220 ÷ 240 mm
e	223 ÷ 243 mm	228 ÷ 248 mm	232 ÷ 252 mm	237 ÷ 257 mm	249 ÷ 269 mm	247 ÷ 267 mm	240 ÷ 260 mm
F	243 ÷ 263 mm	248 ÷ 268 mm	252 ÷ 272 mm	257 ÷ 277 mm	269 ÷ 289 mm	267 ÷ 287 mm	260 ÷ 280 mm
G	263 ÷ 283 mm	268 ÷ 288 mm	272 ÷ 292 mm	277 ÷ 297 mm	289 ÷ 309 mm	287 ÷ 307 mm	280 ÷ 300 mm
H	283 ÷ 303 mm	288 ÷ 308 mm	292 ÷ 312 mm	297 ÷ 317 mm	309 ÷ 329 mm	307 ÷ 327 mm	300 ÷ 320 mm
I	303 ÷ 323 mm	308 ÷ 328 mm	312 ÷ 332 mm	317 ÷ 337 mm	329 ÷ 349 mm	327 ÷ 347 mm	320 ÷ 340 mm
J	323 ÷ 343 mm	328 ÷ 348 mm	332 ÷ 352 mm	337 ÷ 357 mm	349 ÷ 369 mm	347 ÷ 367 mm	340 ÷ 360 mm
K	343 ÷ 363 mm	348 ÷ 368 mm	352 ÷ 372 mm	357 ÷ 377 mm	369 ÷ 386 mm	367 ÷ 387 mm	360 ÷ 380 mm

PROJECT PREMIUM COVER*

Adjustment range	AGAT, OPAL, QUARTZ 27 dB, 32 dB	GRANIT, EI 30	Silence 37 dB rebated, EXTREME RC2 and RC3	EXTREME RC4	SILENCE 37 dB, non-rebated	Rw=42 dB
B	133 ÷ 153 mm	138 ÷ 158 mm	142 ÷ 162 mm	147 ÷ 167 mm	159 ÷ 179 mm	157 ÷ 177 mm
C	153 ÷ 173 mm	158 ÷ 178 mm	162 ÷ 182 mm	167 ÷ 187 mm	179 ÷ 199 mm	177 ÷ 197 mm
D	173 ÷ 193 mm	178 ÷ 198 mm	182 ÷ 202 mm	187 ÷ 207 mm	199 ÷ 219 mm	197 ÷ 217 mm
E	193 ÷ 213 mm	198 ÷ 218 mm	202 ÷ 222 mm	207 ÷ 227 mm	219 ÷ 239 mm	217 ÷ 237 mm
F	213 ÷ 233 mm	218 ÷ 238 mm	222 ÷ 242 mm	227 ÷ 247 mm	239 ÷ 259 mm	237 ÷ 257 mm
G	233 ÷ 253 mm	238 ÷ 258 mm	242 ÷ 262 mm	247 ÷ 267 mm	259 ÷ 279 mm	257 ÷ 277 mm
H	253 ÷ 273 mm	258 ÷ 278 mm	262 ÷ 282 mm	267 ÷ 287 mm	279 ÷ 299 mm	277 ÷ 297 mm
I	273 ÷ 293 mm	278 ÷ 298 mm	282 ÷ 302 mm	287 ÷ 307 mm	299 ÷ 319 mm	297 ÷ 317 mm
J	293 ÷ 313 mm	298 ÷ 318 mm	302 ÷ 322 mm	307 ÷ 327 mm	319 ÷ 339 mm	317 ÷ 337 mm
K	313 ÷ 333 mm	318 ÷ 338 mm	322 ÷ 342 mm	327 ÷ 347 mm	339 ÷ 359 mm	337 ÷ 357 mm

* Extra charges for a set of technical or entrance doors

TECHNICAL INFORMATION

DOOR FRAME CONSTRUCTION

Complete PROJECT BIS and PROJECT BIS PREMIUM door frames consist of:

- corner profile steel door frame, made out of galvanized steel 1,2 thick (AGATE) or 1,5 mm thick (OPAL, QUARTZ, EXTREME RC2, RC3, GRANITE class C, Rw=27 dB, Rw=32 dB, Silence Rw=37 dB, Rw=42 dB, EI 30, EI 60), with a special profile for PROJECT covers
- specially milled elements, consisting of a head beam and two jambs and architraves made of wood-based materials

PROJECT covers are produced and delivered as a set of elements to be assembled on site

ACCESSORIES INCLUDED IN THE DOOR FRAME PRICE

Standard accessories, depending on type of door frame and type of door leaf.

DOOR FRAME SIZE, SEE PAGE, 227, TABLE 5

- '80', '90', '100'

In two options:

- To be installed on a finished floor level -'0'
- To be installed under floor level -'-30'

NOTES

- Technical Assessment ITB-KOT-2017/0245 issue 2
- Certificate of conformity no. 0004/D/W, ITB Warsaw
- Minimum wall thickness - ,A' range
- A project door frame requires wall opening to be enlarged $S_0 +30$ mm (± 10) and $H_0 +15$ (± 5) in comparison to STD sizes of steel door frames.

EXTRA CHARGES

door frame cover: colours of CPL 0,2 mm -GROUP II laminate

One door, many possibilities

Check out how you can easily give your door a new character! Take care of the finishing details and fashionable accessories that you can buy without having to replace the entire leaf.

TIP! You can customize any door to yourself and your own style



RETRO MODULE

stylized crown and decorative pilasters for installation with the door frame

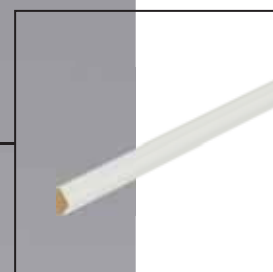

WALL SLAT

wall slat for painting / DoltYourself



SKIRTING BOARD

an elegant and practical way to finish the interior

ADDITIONAL ACCESSORIES

RETRO MODULE

PORTA SYSTEM
+ RETRO module (crown and decorative pilasters)



AVAILABLE FINISHES, colours samples see p. 234 – 241.



Portadecor
Portasynchro 3D



Portalamino
Portaperfect 3D
Natural Veneers



Premium Plus UV Paint

SKIRTING BOARDS

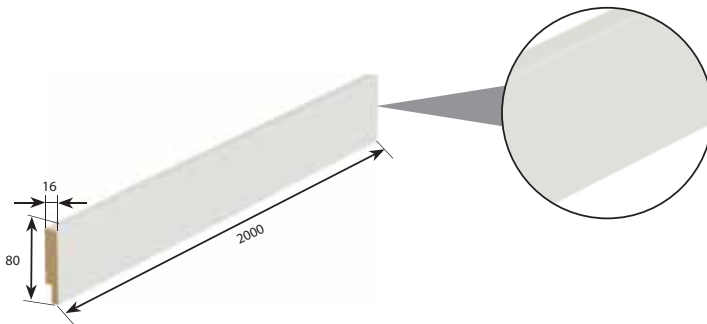

AVAILABLE FINISHES

Portadecor: White, Fiord, Unpainted (prime Paint for self painting)
Premium Plus UV Paint: White and Grey
Portaperfect: Natural Oak, Matt Oak
CPL HQ: Black, Gold Craft Oak.

WALL SLATS

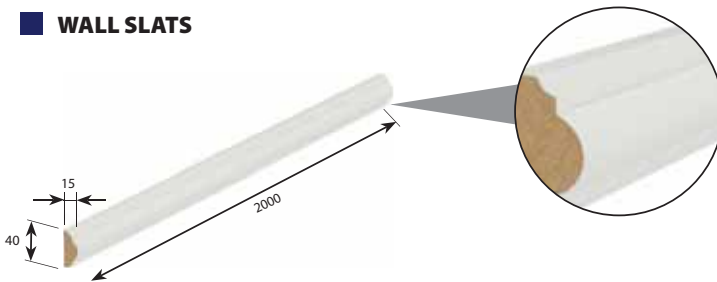

ARCHITRAVES



AVAILABLE FINISHES, colours samples see p. 234 – 241.



Portadecor
Portasynchro 3D



Portalamino
Portaperfect 3D
Premium lacquered Veneer
Natural veneers



Premium Plus UV Paint



Gladstone/Halifax
CPL HQ

Door frame extensions

DOOR FRAME ADJUSTMENT

The door frame can be widened to fit the range of the wall by:

- **Tunnel extension (combination door frame)** - Designed for large wall ranges (max. 588 mm). The solution consists of a standard door frame and an additional widening beam with a connector. Check the dimensions in TABLE 1, p. 224.



- **Adjustment Panel** - a solution enabling the expansion of the standard door frame (max. 460 mm) using an additional panel made of MDF; adjusting panels are available in widths of 80 and 160 mm.

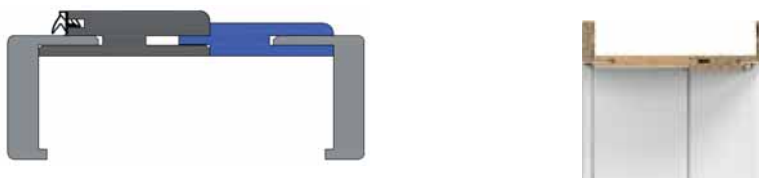

- **Wide tongue** - the architrave with a widened adjustment tongue gives the possibility to increase the range of the wall by an additional 20 mm (while maintaining the 20 mm adjustment). The option is available for PORTA SYSTEM, PORTA SYSTEM ELEGANCE door frames in all finishes.

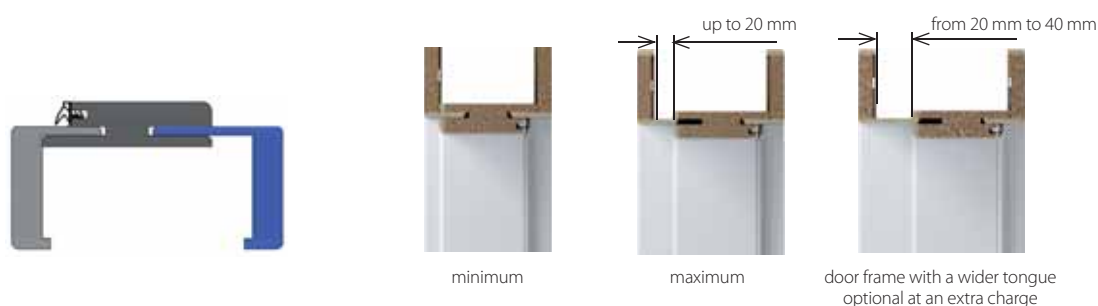

■ RECUPERATION UNDERCUT

In buildings where a heat recovery system is used, it is worth taking care of appropriate doors. PORTA has prepared a recuperative undercut in selected collections. The leaves in this option are 15 mm shorter than standard ones, while maintaining the standard frame height.

Option available in the collections: PORTA VECTOR Premium, PORTA ART DECO, PORTA HIDE.

Note: only available for the Polish norm.



PORTA VECTOR Premium



Porta VECTOR Premium with recuperative undercut



PORTA VECTOR Premium with ventilation undercut

■ VENTILATION



Ventilation sleeves
- 1 row (different colours)



Ventilation sleeves
- 2 rows (different colours)



Ventilation sleeves.
- Available colours:
- square sleeves: gold, matt gold, silver, matt silver
- round sleeves: silver, matt silver



Ventilation slit



Ventilation grille (different colours)
- This ventilation grille meets the building law regulations regarding bathroom ventilation.

SHOP CONVENIENTLY AS A SET ACCESSORIES

15

→ Choose accessories **according to your needs**



ELEGANT handle

✔ A LOT OF COLOURS

Our door handles are available in many colours, **you can easily match them with other elements in your interior.** Buying accessories as a set, you **can conveniently match them**, you are sure that the colour of all elements (door handle, lock, hinges) will match.



LUNGO handle

✔ DIFFERENT STYLES

In our offer you will find a door handle, **no matter what style your interior is.** Door handles with geometric shapes and minimalist design are perfect for a modern style. Door handles with a long sign and rounded shapes will look great in classic interiors.



AZURA: handle + floor stop + furniture handles

✔ FUNCTIONAL

In our offer you will find a collection, which combines: **handles, furniture handles, hangers and stoppers**, thanks to which you will create, stylistically consistent and functional interior. In addition, you will find door pulls and handles that will transform your interior in a non-obvious way.

AZURA Collection

Due to printing technology, the colour of presented products in the catalogue may slightly differ from the actual product.

AZURA BLACK (escutcheon thickness 9 mm)



AZURA GOLD (escutcheon thickness 9 mm)



AZURA SILVER (escutcheon thickness 9 mm)



*The values specified next to the longitudinal furniture handles (320 mm, 192 mm, 128 mm) indicate the gap between the screws used for mounting the handle.

Handles

Due to printing technology, the colour of presented products in the catalogue may slightly differ from the actual product.

EUPHORIA (escutcheon thickness 9 mm)



black



silver

Handle

Key lock escutcheon,
euro cylinder escutcheon
WC escutcheon



SEGURA (escutcheon thickness 9 mm) NEW



black



silver

Handle

Key lock escutcheon,
euro cylinder escutcheon
WC escutcheon



TOPAZ (escutcheon thickness 10 mm)



silver

Handle

Key lock escutcheon,
euro cylinder escutcheon
WC escutcheon



UNICO (escutcheon thickness 9 mm)



black structure



anthracite structure

Handle

Key lock escutcheon,
euro cylinder escutcheon
WC escutcheon



RUMBA (escutcheon thickness 9 mm)



glossy chrome



nickel



black

Handle

Key lock escutcheon,
euro cylinder escutcheon
WC escutcheon



Due to printing technology, the colour of presented products in the catalogue may slightly differ from the actual product.

■ NEXT (escutcheon thickness 9 mm)



silver



silver matt



gold matt



Handle
Key lock escutcheon,
euro cylinder escutcheon
WC escutcheon

■ OFFICE (escutcheon thickness 9.5 mm)



silver



silver matt



anthracite



gold



gold matt



Handle
Key lock escutcheon,
euro cylinder escutcheon
WC escutcheon

■ CUBE (escutcheon thickness 9 mm)



brushed chrome matt



brushed nickel matt



black



Handle
Key lock escutcheon,
euro cylinder escutcheon
WC escutcheon

■ ELEGANT (escutcheon thickness 6 mm)

WE RECOMMEND
A Modern thin escutcheon is a class of its own.



silver



white



black



Set: handle + key lock escutcheon
or euro cylinder escutcheon
Set: handle + WC escutcheon

■ DIVO FIT Q (escutcheon thickness 6 mm)

WE RECOMMEND
A Modern thin escutcheon is a class of its own.



chrome



satin chrome



black



Handle
Key lock escutcheon,
euro cylinder escutcheon
WC escutcheon

Handles

■ MAXIMA (escutcheon thickness 9 mm)



chrome



brushed chrome



black



Handle
Key lock escutcheon,
euro cylinder escutcheon
WC escutcheon

■ MAXIMA CONNECT (escutcheon thickness 9 mm)



black with white insert



Handle
Key lock escutcheon,
euro cylinder escutcheon
WC escutcheon

■ DORO (escutcheon thickness 9 mm) NEW



black



silver



Handle
Key lock escutcheon,
euro cylinder escutcheon
WC escutcheon

■ ORGANIC (escutcheon thickness 9 mm)



black structure



anthracite structure



Handle
Key lock escutcheon,
euro cylinder escutcheon
WC escutcheon

■ MODERN PLUS (escutcheon thickness 11 mm)



silver



silver matt



gold matt



Handle
Key lock escutcheon,
euro cylinder escutcheon
WC escutcheon

Due to printing technology, the colour of presented products in the catalogue may slightly differ from the actual product.

■ ACCENT PLUS (escutcheon thickness 9 mm)



silver



silver matt



gold matt



Handle
Key lock escutcheon,
euro cylinder escutcheon
WC escutcheon

■ LEA (escutcheon thickness 9 mm)



gold



black



Handle
Key lock escutcheon,
euro cylinder escutcheon
WC escutcheon

■ LUNA SLIM (escutcheon thickness 6 mm)

WE RECOMMEND
A Modern thin escutcheon is a class of its own.



gold



chrome



brushed chrome



black



Handle
Key lock escutcheon,
euro cylinder escutcheon
WC escutcheon

■ BELLA SLIM (escutcheon thickness 6 mm)

WE RECOMMEND
A Modern thin escutcheon is a class of its own.



chrome



gold



black



Handle
Key lock escutcheon,
euro cylinder escutcheon
WC escutcheon

■ RONDA (escutcheon thickness 6 mm)

WE RECOMMEND
A Modern thin escutcheon is a class of its own.



gold matt



black



Handle
Key lock escutcheon,
euro cylinder escutcheon
WC escutcheon

Handles

Due to printing technology, the colour of presented products in the catalogue may slightly differ from the actual product.

■ SIMPLE (escutcheon thickness 6 mm)

WE RECOMMEND

A Modern thin escutcheon is a class of its own.



silver



white



black



Set: handle + key lock
escutcheon or euro cylinder
escutcheon
Set: handle + WC escutcheon

■ DIVO FIT (escutcheon thickness 6 mm)

WE RECOMMEND

A Modern thin escutcheon is a class of its own.



chrome



satin chrome



black



Handle
Key lock escutcheon,
euro cylinder escutcheon
WC escutcheon

■ AZALIA (escutcheon thickness 7 mm)



gold



satine chrome, polished chrome, black



Handle
Key lock escutcheon,
euro cylinder escutcheon
WC escutcheon

■ ORTICA (escutcheon thickness 7 mm)



gold



polished chrome, black



knob
Key lock escutcheon,
euro cylinder escutcheon
WC escutcheon

■ MODERNO (escutcheon thickness 9 mm) NEW



white



black



Handle
Key lock escutcheon,
euro cylinder escutcheon
WC escutcheon

Due to printing technology, the colour of presented products in the catalogue may slightly differ from the actual product.

LUNGO (escutcheon thickness 9.5 mm) NEW



white

black

Key lock escutcheon,
euro cylinder escutcheon
WC escutcheon

ROYAL (escutcheon thickness 9.5 mm)



brushed silver

antique gold

Key lock handle, cylinder lock
Handle for WC lock

Object HANDLES

■ OVAL / class 4 (escutcheon thickness 8 mm)



Handle

Key lock escutcheon

euro cylinder escutcheon

WC escutcheon

stainless steel

■ KVADRAT / class 4 (escutcheon thickness 8 mm)



Handle

Key lock escutcheon

euro cylinder escutcheon

WC escutcheon

stainless steel

■ EDEL / class 3 (escutcheon thickness 10 mm)



Handle

stainless steel

Cylinder

WC lock

■ MINI PLUS (escutcheon thickness 10 mm)



Door handle (72) plastic

black (key lock, euro
cylinder)

MINI PLUS

Handles

Due to printing technology, the colour of presented products in the catalogue may slightly differ from the actual product.

■ PORTA AGAT (1ST EUROPEAN CLASS) escutcheon thickness from the side: outside 12 mm, inside 8 mm

Door handle (72)	with a standard hold	with a 'knob' hold	escutcheon for an upper lock
silver, black			



■ PORTA OPAL (2ND EUROPEAN CLASS) escutcheon thickness from the side: outside 12 mm, inside 8 mm

Door handle (72)	with a standard hold	with a 'knob' hold	escutcheon for an upper lock
inox, titanium			



■ PORTA GRANIT (3RD EUROPEAN CLASS, FORMERLY CLASS 'C') escutcheon thickness from the side: outside 12 mm, inside 8,5 mm

Door handle (72)	with a standard hold	with a 'knob' hold	escutcheon for an upper lock
inox, titanium			



■ ROYAL (3RDEUROPEAN CLASS, FORMERLY CLASS 'C') escutcheon thickness from the side: outside 12 mm, inside 8,5 mm

Door handle (72)	with a standard hold	with a 'knob' hold	escutcheon for an upper lock
Inox, black			



■ PORTA SAFE (3RD SAFETY CLASS) escutcheon thickness from the side: outside 12 mm, inside 8,5 mm

Door handle (92)	with a standard hold	with a 'knob' hold	escutcheon for an upper lock
inox, titanium, black			

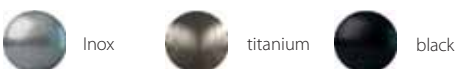

Additional accessories

■ SMART ELECTRONIC LOCK

A wireless cylinder drive, allowing you to remotely control access to, for example, your home or flat from anywhere in the world. As an administrator, you can create an unlimited number of remote keys for family members, guests or employees. Allows you to set permanent or temporary access.

SALTO DANALOCK v3



Silver

Use with EXTREME RC3 doors (for 30/40G or 30G/40 cylinders).
The use of electronic lock (escutcheon) does not affect the door classification.

SET

electronic lock (escutcheon)

adapter - necessary for the installation of the electronic lock on the cylinder

WiFi bridge

set of WILKA cylinders - 1 with knob, 1 with safety coupling

■ A SET FOR CLEANING, REFRESHING AND REGENERATING OF DOOR SURFACES



PORTA DOOR CARE

Regular use of the preparations ensures that the doors are kept clean and in perfect condition, guaranteeing the highest level of satisfaction.

It is recommended to use regularly every 2-3 weeks, in case of intensive dirt more often, and in the mean time wipe the door with a soft and dry cloth, without using additional cleaning agents.

THE SET INCLUDES:

PORTA Door Cleaner – a preparation for door surfaces cleaning

A preparation for thorough cleaning of all types of door surface. It does not change gloss. It removes traces after grease, stickers, waxes, pens, pencils, markers, shoe paste, nicotine, etc. It has antistatic properties.

PORTA Door Refresher – a preparation for refreshing and regenerating of door surface.

A preparation for refreshing and regenerating of all types of Natural wood, Veneer, board and varnished modern and stylized door surfaces. It removes grey stains after water and alcohol. It enlivens colour and restores original appearance of door surface. Do not use for high gloss, waxed or oiled door surfaces. It does not contain wax or silicone.

Additional accessories

DOOR HANDLE PLATES

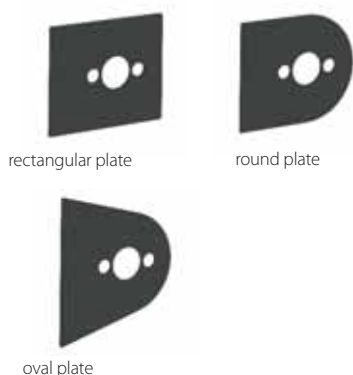

rectangular plate

round plate

oval plate

STAINLESS STEEL PORTHOLE



- Porthole is available only with door leaves with hollow chipboard core for following solid models: MINIMAX, PORTA DECOR, PORTA CPL, ENDURO, Nature CLASSIC, PORTA RESIST.
- Diameter: 350 mm.
- Available glass panels: transparent or laminated satin glass panel class 2,6 mm thick.

ENTRANCE DOOR HARDWARE



Wide angle viewer

Two euro cylinders, class, B'
- silver, golden, black

THRESHOLD



Stainless steel threshold, compatible with PORTA door frames:

- standard (90 mm)
- widened (120 mm)

- for double leaf doors:
- standard (90 mm)
- widened (120 mm)

DOOR CLOSER

Door closer
- silver and brown colour

PULLS



Hook lock, key or WC with side and front pulls. For sliding doors.

- Available in following colours: golden, matt gold, silver, matt silver

Round pull handle for sliding doors - in the price of a door leaf.
- colours: silver and gold and black.

ELECTRIC STRIKES



Electric strike for steel door frames:

- Corner profile - LARGE and Adjustable
- fail secure
- fail-safe



Electric strike for PORTA SYSTEM door frame

- fail secure
- fail-safe

PREPARATION FOR SHORTENING

Rectangular and longitudinal door pulls for sliding doors.
- colours: gold, matt gold, silver, matt silver, black

Preparation for shortening the door leaf maximum 60 mm

Additional accessories

LOCKS



Magnetic lock with stainless steel face plate, black, white and gold



PRIME lock with gold or silver face plate.



Lock with black face plate. (not available as cylinder option)

HINGES



3D hinges. Door part, frame part.

- golden

- silver, white, black



PRIME barrel hinges. Door part, frame part.

- golden, matt gold, silver, matt silver



Standard barrel hinges. Door part, frame part.

- silver



Standard barrel hinges. Door part, frame part.

- black



Adjustable barrel hinges 3D. Door part, door frame part.

- silver

GREAT PRICE

HINGES CAPS



Standard hinges caps for internal doors (a set for one hinge)

- gold, matt silver, gloss chrom
- white, black



Villadora hinges caps (a set for one hinge)

- golden gloss, old gold, silver gloss

EURO CYLINDER FOR INTERIOR DOORS



Euro cylinder for interior doors size:30/30, 26/35

- black
- silver

Door dimensions tables

MINIMAX DOOR FRAME

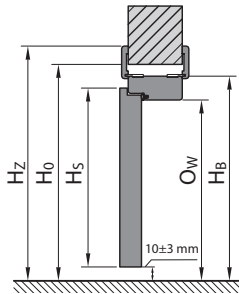
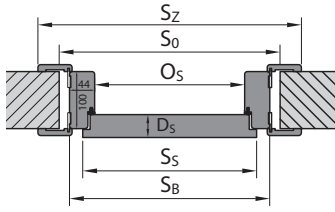

PORTA SYSTEM DOOR FRAME

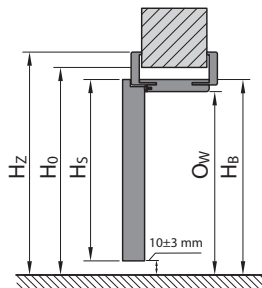
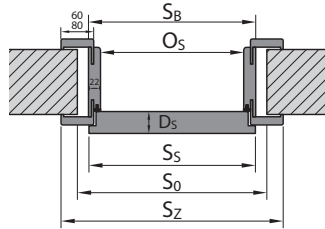

PORTA SYSTEM ELEGANCE DOOR FRAME

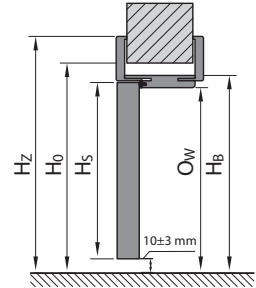
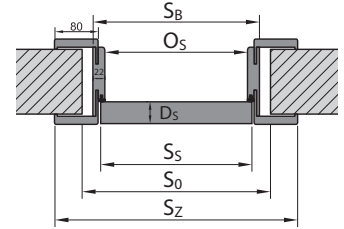

LEVEL DOOR FRAME

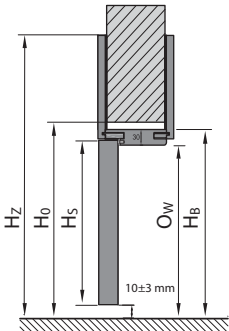
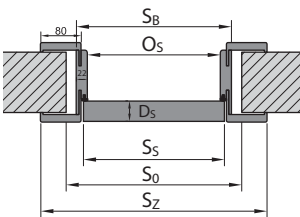

STEEL DOOR FRAME

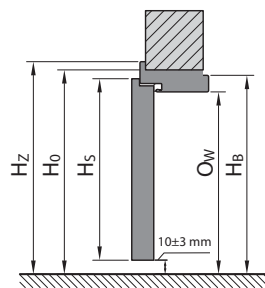
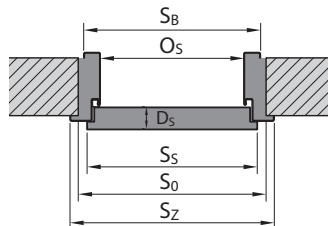

NON-REBATED STEEL DOOR FRAME

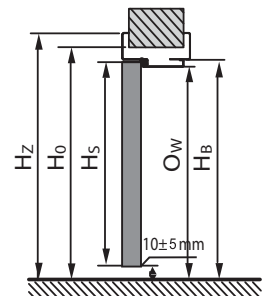
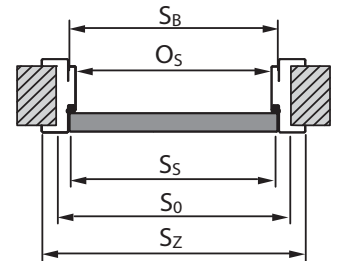

Door dimensions tables

PORTA HIDE

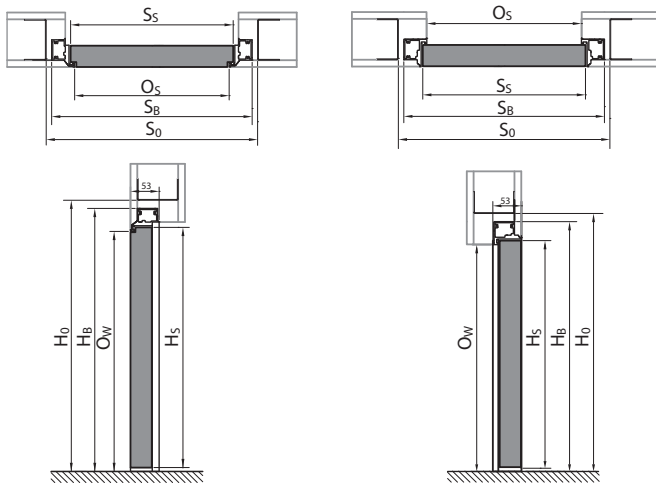

DOOR FRAME WITH REVERSED REBATE

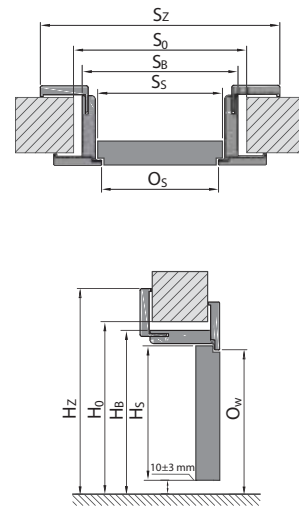

PORTA SLIDING SYSTEM

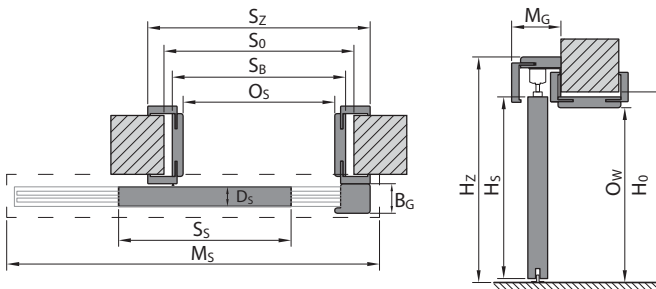

COMPACT SLIDING SYSTEM

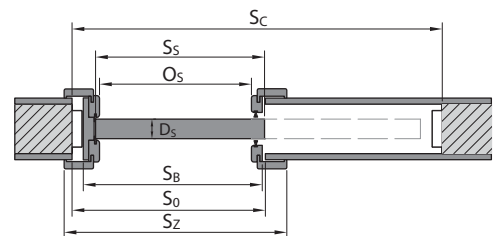

FRAMELESS SLIDING SYSTEM

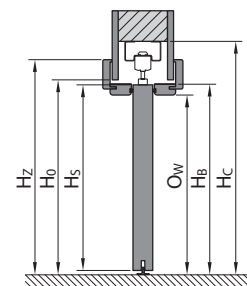
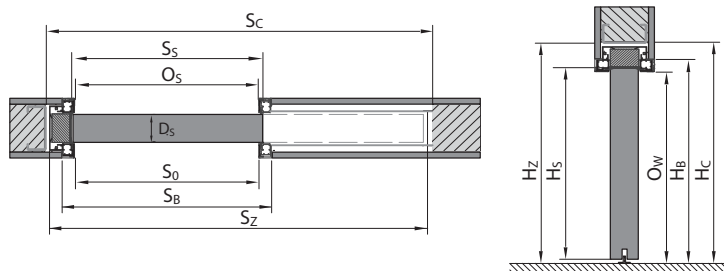

KEY TO DIMENSIONS

- S_s total width of the door leaf (including the rebates)
- H_s total height of the door leaf (including the rebate)
- D_s door leaf thickness
- S_0 width of the wall opening prepared for embedding the frame
- H_0 height of the wall opening prepared for embedding the frame, measured from the level of the finished floor
- O_s opening width (for Alfa and Beta this dimension is decreased by the door leaf thickness)
- O_w opening height (measured from finished floor level)
- S_b door frame width without architraves
- H_b door frame height, dimension without architraves
- S_z total door frame width with architraves
- H_z total height of door frame, including architraves
- M_s width of sliding door masking system
- M_g thickness of a rail cover (sliding systems)
- B_g thickness of a door stop (jamb) (sliding systems)
- T_{sw} permissible tolerance of deviation in width | height of wall opening
- S_c wall opening width for a metal cassette (pocket door system)
- H_c wall opening height for a metal cassette (pocket door system), (measured from finished floor level)

Refer to architrave 60/80 mm in dimension tables (S_z).

Door dimensions tables

POLISH NORM (PN)

INTERNAL DOORS WITH WOODEN DOOR FRAMES

TABLE 1

Table with dimension for internal double doors you can find on: www.porta.com.pl/do-pobrania

In order to obtain dimension S_2 for double leaf doors it is necessary:

- a) for rebated door leaves with PORTA SYSTEM frame: to the S_0 dimension given in Table 1 for single door leaf, add the S_2 dimension of the second (rebated) leaf or of the side panel (rebated)
- b) for rebated door leaves with other frames: to the door leaf dimension S_0 given in Table 1 for the single door leaf (rebated) door leaf, add the S_2 dimension of the second (rebated) door leaf or side panel, and reduce the resulting value additionally by 10 mm.
- c) for non-rebated leaves: to the S_0 dimension given in Table 1 for the single (non-rebated) door leaf, add the S_2 dimension of the second (non-rebated) door leaf or the side panel (non-rebated) door leaf, increased by 16 mm.

DOOR FRAME TYPE	SIZE	S_s	H_s	D_s	S_0	H_0	O_s	O_w	S_b	H_b	$S_2(6)$	$S_2(8)$	H_2	T_{sw}
Minimax 60 mm, Minimax 100 mm, MDF in Natural Veneer	60	644	2030	40	710	2075	602	2016	690	2060	800	–	2115	+20 / +10
	70	744			810		702		790		900	–		
	80	844			910		802		890		1000	–		
	90	944			1010		902		990		1100	–		
	100	1044			1110		1002		1090		1200	–		
PORTA SYSTEM	60	644	2030	40	680	2060	602	2016	646	2038	746	786	architrave (6) / (8) 2088 / 2108	+20 / +10
	70	744			780		702		746		846	886		
	80	844			880		802		846		946	986		
	90	944			980		902		946		1046	1086		
	100	1044			1080		1002		1046		1146	1186		
	110	1144			1180		1102		1146		1246	1286		
PORTA SYSTEM ELEGANCE LEVEL	60	618	2017	40	690	2060 / 2070	602	2016	646	2038 / 2046	–	786	2108 / top panel (20) / (100) 2228/3028	+10 / +10
	70	718			790		702		746		–	886		
	80	818			890		802		846		–	986		
	90	918			990		902		946		–	1086		
	100	1018			1090		1002		1046		–	1186		
PORTA SYSTEM ELEGANCE 90 degrees	60	618	2017	40	690	2060	602	2016	646	2038	–	786	2108	+10/+10
	70	718			790		702		746		–	886		
	80	818			890		802		846		–	986		
	90	918			990		902		946		–	1086		
	100	1018			1090		1002		1046		–	1186		
PORTA SYSTEM with reversed rebate*	60	639	2027	40	720	2080	626	2028	691	2061	–	831	2130	±10/±5
	70	739			820		726		791		–	931		
	80	839			920		826		891		–	1031		
	90	939			1020		926		991		–	1131		
	100	1039			1120		1026		1091		–	1231		
RENOVA**	60	644	2030	40	596	2016	558	1994	584	2007	746	–	2088	+15 / -6
	70	744			696		658		684		846	–		
	80	844			796		758		784		946	–		
	90	944			896		858		884		1046	–		
	100	1044			996		958		984		1146	–		
	110	1144			1096		1058		1084		1246	–		
Villadora RETRO	60	644	2030	40	680	2060	602	2016	646	2038	–	789	2110	+20 / +10
	70	744			780		702		746		–	889		
	80	844			880		802		846		–	989		
	90	944			980		902		946		–	1089		
	100	1044			1080		1002		1046		–	1189		

EXTENDING OF REGULATION RANGE OF THE ADJUSTABLE FRAME PORTA SYSTEM WITH A TUNNEL PORTA SYSTEM WITH COMBINING FEATHER

DOOR FRAME TYPE	Regulation range [mm]	DOOR FRAME TYPE	Regulation range [mm]	DOOR FRAME TYPE	Regulation range [mm]	DOOR FRAME TYPE	Regulation range [mm]	DOOR FRAME TYPE	Regulation range [mm]
D+D	288-308	G+F	388-408	I+I	488-508	K+L	588-608	N+N	688-688
E+D	308-328	G+G	408-428	J+J	508-528	L+L	608-628		
E+E	328-348	H+G	428-448	J+J	528-548	L+M	628-648		
F+E	348-368	H+H	448-468	K+J	548-568	M+M	648-668		
F+F	368-388	I+H	468-488	K+K	568-588	M+N	668-688		

NOTE: S_2 and H_2 dimensions of door frame in Natural veneers are given with tolerance -1 mm/ + 3 mm.

*Dimension S_2 and H_2 measured on the wider side of the door leaf. They are the same as dimensions of doors with PSE

** S_2 /H₂ width/height of clear opening of old steel frame. T_{sw} - tolerance +15 mm depends on a construction of the old door frame

*** Villadora RETRO - size „110“ not available, architraves width 6 cm

PORTA HIDE DOORS

TABLE 2

DOOR FRAME TYPE	SIZE	S_s	H_s	S_0	H_0	O_s	O_w	S_b	H_b
PORTA HIDE non-rebated (opening outward)	70	718	2017	800	2070	703	2017	787	2059
	80	818		900		803		887	
	90	918		1000		903		987	
PORTA HIDE with reversed rebate (inward opening)	70	718	2027	800	2080	703	2027	787	2069
	80	818		900		803		887	
	90	918		1000		903		987	

Door dimensions tables

POLISH NORM (PN)

INTERNAL DOORS WITH STEEL DOOR FRAMES

TABLE 3

DOOR FRAME TYPE	SIZE	S _s	H _s	D _s	S _o	H _o	O _s	O _w	S _b	H _b	S _z	H _z	T _{sw}
Corner profile door frame - SMALL PLUS	60	644	2030	40	649	2043	596	2016	629	2033	706	2071	±10/±5
	70	744			749		696		729		806		
	80*	844			849		796		829		906		
	90*	944			949		896		929		1006		
	100	1044			1049		996		1029		1106		
Corner profile door frame - LARGE, LARGE BASIC for concrete walls and stainless steel LARGE folding	60	644	2030	40	675	2055	596	2016	656	2046	706	2071	±10/±5
	70	744			775		696		756		806		
	80*	844			875		796		856		906		
	90*	944			975		896		956		1006		
	100	1044			1075		996		1056		1106		
	110	1144			1175		1096		1156		1206		
Corner profile door frame - LARGE, LARGE BASIC, plasterboard walls	60	644	2030	40	685	2055	596	2016	680	2046	706	2071	+10/+5
	70	744			785		696		780		806		
	80*	844			885		796		880		906		
	90*	944			985		896		980		1006		
	100	1044			1085		996		1080		1106		
Adjustable, Adjustable BASIC steel door frame	60	644	2030	40	690	2063	596	2016	670	2053	716	2076	-10/-5
	70	744			790		696		770		816		
	80*	844			890		796		870		916		
	90*	944			990		896		970		1016		
	100	1044			1090		996		1070		1116		
Adjustable PS with ,sharp edges'	60	644	2030	40	700	2070	596	2016	679	2058	736	2086	-10/-5
	70	744			800		696		779		836		
	80*	844			900		796		879		936		
	90*	944			1000		896		979		1036		
	100	1044			1100		996		1079		1136		
Steel PORTA SYSTEM	60	644	2030	40	675	2055	596	2016	646	2041	736	2086	±10/±5
	70	744			775		696		746		836		
	80*	844			875		796		846		936		
	90*	944			975		896		946		1036		
	100	1044			1075		996		1046		1136		
Steel PORTA SYSTEM ELEGANCE**	60	618	2017	40	676	2056	596	2016	646	2041	736	2086	±10/±5
	70	718			776		696		746		836		
	80	818			876		796		846		936		
	90	918			976		896		946		1036		
	100	1018			1076		996		1046		1136		
Corner profile non-rebated - LARGE for concrete walls**	60	618	2017	40	676	2056	596	2016	656	2046	736	2086	±10/±5
	70	718			776		696		756		836		
	80	818			876		796		856		936		
	90	918			976		896		956		1036		
	100	1018			1076		996		1056		1136		
Corner profile non-rebated - LARGE for plasterboard walls**	60	618	2017	40	681	2056	596	2016	656	2046	736	2086	+10/+5
	70	718			781		696		756		836		
	80	818			881		796		856		936		
	90	918			981		896		956		1036		
	100	1018			1081		996		1056		1136		
Adjustable, non-rebated steel door frame	60	618	2017	40	690	2063	596	2016	670	2053	736	2086	-10/-5
	70	718			790		696		770		836		
	80	818			890		796		870		936		
	90	918			990		896		970		1036		
	100	1018			1090		996		1070		1136		
Adjustable, non-rebated steel door frame	60	618	2017	40	690	2063	596	2016	670	2053	736	2086	-10/-5
	70	718			790		696		770		836		
	80	818			890		796		870		936		
	90	918			990		896		970		1036		
	100	1018			1090		996		1070		1136		
Adjustable, non-rebated steel door frame	60	618	2017	40	690	2063	596	2016	670	2053	736	2086	-10/-5
	70	718			790		696		770		836		
	80	818			890		796		870		936		
	90	918			990		896		970		1036		
	100	1018			1090		996		1070		1136		

PORTA LOFT STEEL

DOOR FRAME TYPE	SIZE	S _o	H _o	S _z /S _b	H _z /H _o
PORTA LOFT Steel	80	874	2053	864	2048
	90	974		964	

***NOTE!** Investment norm (clear opening width 800,900 mm) is available as a standard without an extra charge - add 8 mm to S_o dimension. Please, remember to order suitable size of door leaves which are dedicated for the set.

**If the back of the hinge does not fit in a wall opening, a little wall chasing has to be made.

Door dimensions tables

POLISH NORM (PN)

TECHNICAL DOORS

TABLE 4

DOOR FRAME TYPE	SIZE	S ₃	H ₃	D ₃	S ₀	H ₀	O ₃	O _w	S ₀	H ₀	S ₂ (6)	S ₂ (8)	H ₂	T _{s/w}
Rw=27 dB with PORTA SYSTEM door frame	60	644	2030	40	680	2060	602	2016	646	2038	746	786	architrave (6) / (8) 2088 / 2108	+20 / +10
	70	744			780		702		746		846	886		
	80	844			880		802		846		946	986		
	90	944			980		902		946		1046	1086		
	100	1044			1080		1002		1046		1146	1186		
Rw=32 dB with PORTA SYSTEM door frame	60	644	2030	44	680	2060	602	2016	650	2040	746	786	architrave (6) / (8) 2088 / 2108	+20 / +10
	70	744			780		702		750		846	886		
	80	844			880		802		850		946	986		
	90	952			988		910		958		1054	1094		
	100	1044			1080		1002		1050		1146	1186		
PORTA SILENCE Rw=37 dB adjustable rebated	80	844	2030	49 / 50	880	2060	802	2016	850	2040	946	986	2088/2108	+20 / +10
	90	968			1004		926		974		1070	1110		
	100	1044			1080		1002		1050		1146	1186		
PORTA SILENCE Rw=37 dB adjustable non-rebated	80	818	2017	49 / 50	880	2060	801	2016	849	2040	-	985	-/2108	+20 / +10
	90	968			1030		951		999		-	1135		
	100	1018			1080		1001		1049		-	1185		
PORTA SILENCE Rw=37 dB fixed rebated	80	844	2030	49 / 50	950	2090	802	2017	922	2077	1024	1064	2128/2148	±10 / ±5
	90	968			1074		926		1046		1148	1188		
	100	1044			1150		1002		1122		1224	1264		
PORTA SILENCE Rw=37 dB fixed non-rebated	80	818	2017	49 / 50	950	2090	801	2017	921	2077	-	1063	-/2148	±10 / ±5
	90	968			1100		951		1071		-	1213		
	100	1018			1150		1001		1121		-	1263		
PORTA SILENCE Rw=37 dB rebated with a steel door frame	80	844	2030	49 / 50	876	2055	796	2013	856	2043	906	-	2068	±10 / ±5
	90	968			1000		920		980		1030	-		
	100	1044			1076		996		1056		1106	-		
PORTA SILENCE Rw=37 dB non-rebated with a steel door frame	80	818	2017	49 / 50	875	2055	795	2013	855	2043	905	-	2068	+10 / +5
	90	968			1026		945		1005		1055	-		
	100	1018			1075		995		1055		1105	-		
Rw = 42 dB with reinforced PORTA SYSTEM door frame	80	868	2047	68 / 69	915	2080	802	2020	872	2056	968	1008	architrave (6) / (8) 2104 / 2124	+20 / +10
	90	968			1015		902		972		1068	1108		
	100	1068			1115		1002		1072		1168	1208		
Rw = 42 dB with MDF door frame	80	868	2047	68 / 69	975	2105	802	2021	946	2093	1048	1088	architrave (6) / (8) 2144 / 2164	±10 / ±5
	90	968			1075		902		1046		1148	1188		
	100	1068			1175		1002		1146		1248	1288		
Rw = 42 dB with steel door frame*	80	888	2047	68 / 69	890	2055	810	2015	870	2045	950	-	2085	±10 / ±5
	90	988			990		910		970		1050	-		
	100	1088			1090		1010		1070		1150	-		
EI 30 with MDF door frame	60	644	2030	44 / 45	750	2090	602	2014	722	2077	824	864	architrave (6) / (8) 2128 / 2148	±10 / ±5
	70	744			850		702		822		924	964		
	80	844			950		802		922		1024	1064		
	90	952			1060		910		1030		1132	1172		
	100	1044			1150		1002		1122		1224	1264		
EI 30, Rw = 27 dB, Rw = 32 dB with a steel door frame*	60	644	2030	44 / 45 40 / 41 44 / 45	675	2055	596	2013	656	2043	706	-	2068	±10 / ±5
	70	744			775		696		756		806	-		
	80	844			875		796		856		906	-		
	90	952			985		904		964		1014	-		
	100	1044			1075		996		1056		1106	-		
Rw = 27 dB, Rw = 32 dB with a steel door frame for plaster- board walls	60	644	2030	40 / 41 44 / 45	685	2058	596	2013	680	2058	706	-	2068	+10 / +5
	70	744			785		696		780		806	-		
	80	844			885		796		880		906	-		
	90	952			993		904		988		1014	-		
	100	1044			1085		996		1080		1106	-		
ENDURO	60	644	2030	40	675	2055	596	2016	656	2046	706	-	2071	±10 / ±5
	70	744			775		696		756		806	-		
	80	844			875		796		856		906	-		
	90	952			983		904		964		1014	-		
	100	1044			1075		996		1056		1106	-		
ENDURO with a swinging door frame	60	618	2017	40	750	2085	638	2030	728	2075	728	-	2075	±10 / ±5
	70	718			850		738		828		828	-		
	80	818			950		838		928		928	-		
	90	918			1050		938		1028		1028	-		
	100	1044			1093		1004		1088		1114	-		
Strength performance Class 4 with corner profiledoor frame LARGE for concrete walls	70	752	2030	40	793	2055	704	2016	788	2046	814	-	2071	±10 / ±5
	80	852			883		804		864		914	-		
	90	952			983		904		964		1014	-		
	100	1052			1083		1004		1064		1114	-		
	70	752			793		704		788		814	-		
Strength performance Class 4 with corner profiledoor frame LARGE for plasterboard walls	80	852	2030	40	893	2055	804	2016	888	2046	914	-	2071	±10 / ±5
	90	952			993		904		988		1014	-		
	100	1052			1093		1004		1088		1114	-		
	70	752			798		704		778		824	-		
	80	852			898		804		878		924	-		
Strength performance Class 4 with ADJUSTABLE steel door frame	90	952	2030	40	998	2063	904	2016	978	2053	1024	-	2076	±10 / ±5
	100	1052			1098		1004		1078		1124	-		
	70	752			784		704		754		844	-		
	80	852			884		804		854		944	-		
	90	952			984		904		954		1044	-		
Strength performance Class 4 with steel PORTA SYSTEM	100	1052	2030	40	1084	2056	1004	2016	1054	2041	1144	-	2086	±10 / ±5
	70	715			760		700		739		796	-		
	80	815			860		800		839		896	-		
	90	915			960		900		939		996	-		
	100	1052			1084		1004		1054		1144	-		
Multipurpose doors for utility rooms	70	715	2017	40***	760	2050	700	2018	739	2038	796	-	2066	±10 / ±5
	80	815			860		800		839		896	-		
	90	915			960		900		939		996	-		
Steel BASIC and Steel BASIC PLUS with a corner profile door frame - SMALL PLUS	80	852	2030	40	857	2043 - Basic 2047 - Basic PLUS	804	2016	837	2033	914	-	2071 - Basic 2075 - Basic PLUS	±10 / ±5
	90	952			957		904		937		1014	-		
	100	1052			1057		1004		1037		1114	-		

* Project (BIS and Premium) requires enlarging the wall opening S₀ by 30 mm and H₀ by 15 mm (dimension tolerance +10 mm / +5 mm)

Other Project door frame sizes, see drawing on page 205.

** Steel threshold decreases given dimension by 16 mm.

*** Door leaf thickness is measured on vertical edges (door leaf without infill, opened from closing side).

Door dimensions tables

POLISH NORM (PN)

TECHNICAL DOORS

TABLE 5

DOOR FRAME TYPE	SIZE	S ₃	H ₃	D ₃	S ₀	H ₀	O ₃	O _w	S _B	H _B	S ₂ (6)	S ₂ (8)	H ₂ (8)	T _{sw}
EI 60 with a wooden door frame	60	668	2030	60 / 61	775	2090	628	2017	747	2077	858	-	2133	±10 / ±5
	70	768			875		728		847		958	-		
	80	868			975		828		947		1058	-		
	90	968			1075		928		1047		1158	-		
EI 60 with a steel door frame*	60	668	2030	60 / 61	700	2055	618	2011	678	2041	732	-	2068	±10 / ±5
	70	768			800		718		778		832	-		
	80	868			900		818		878		932	-		
	90	968			1000		918		978		1032	-		
EI30 PLUS, EI60 PLUS	60	720	2040	62	745	2065	660	2023	730	2057	780	-	2083	±10 / ±5
	70	820			845		760		830		880	-		
	80	920			945		860		930		980	-		
	90	1020			1045		960		1030		1080	-		
EI30 PLUS, EI60 PLUS double	90+30**	1423	2040	62	1445	2065	1363	2023	1431	2057	1483	-	2083	±10 / ±5
	90+40**	1523			1545		1463		1531		1583	-		
	90+50**	1623			1645		1563		1631		1683	-		
	90+60	1723			1745		1663		1731		1783	-		
	90+70	1823			1845		1763		1831		1883	-		
	90+80	1923			1945		1863		1931		1983	-		
INNOVO 37 dB with PORTA SYSTEM door frame	60	644	2030	44	680	2060	602	2016	650	2040	746	786	architrave (6) / (8) 2088 / 2108	+20 / +10
	70	744			780		702		750		846	886		
	80	844			880		802		850		946	986		
	90	968			1005		926		974		1070	1110		
	100	1044			1080		1002		1050		1146	1186		
INNOVO 37 dB with steel door frame	60	644	2030	44	675	2055	596	2013	656	2043	706	-	2068	+10 / +5
	70	744			775		696		756		806	-		
	80	844			875		796		856		906	-		
	90	968			1000		920		980		1030	-		
	100	1044			1075		996		1056		1106	-		
INNOVO 42 dB with MDF door frame	80	888	2047	62	990	2105	822	2021	966	2093	1068	1008	architrave (6) / (8) 2144 / 2164	±10 / ±5
	90	988			1090		922		1066		1168	1108		
	100	1088			1190		1022		1166		1268	1208		
INNOVO 42 dB with PORTA SYSTEM door frame	80	888	2047	62	925	2075	822	2020	894	2056	990	1030	architrave (6) / (8) 2104 / 2124	+20 / +10
	90	988			1025		922		994		1090	1130		
	100	1088			1125		1022		1094		1190	1230		
INNOVO 42 dB with steel door frame	80	888	2047	62	890	2055	810	2015	870	2045	950	-	2085	±10 / ±5
	90	988			990		910		970		1050	-		
	100	1088			1090		1010		1070		1150	-		

** passive leaf - flush door (without glass)

APARTMENT ENTRANCE DOORS

TABLE 6

DOOR FRAME TYPE	SIZE	S ₃	H ₃	D ₃	S ₀	H ₀	O ₃	O _w	S _B	H _B	S ₂ (6)	S ₂ (8)	H ₂	T _{sw}
AGATE, OPAL, QUARTZ, GRANITE kl. C with a steel door frame**	80	844	2030*	40 / 41 44 / 45 48 / 49	876	2056	796	2016***	856	2046	906	-	2071	±10 / ±5
	90	952			966		904		964		1014	-		
	100	1044			1076		996		1056		1106	-		
EXTREME RC2, EXTREME RC 3 with a steel door frame**	80	844	2032	50	876	2056	796	2016	856	2046	906	-	2071	+10 / +5
	90	968			1000		920		980		1030	-		
	100	1044			1076		996		1056		1106	-		
EXTREME RC 3 with PS frame	80	844	2032	50	880	2060	802	2018	850	2042	-	986	2110	+20 / +10
	90	968			1005		926		974		-	1110		
	100	1044			1080		1002		1050		-	1186		
EXTREME RC 4 with a steel door frame**	80	844	2032	54	880	2060	798	2016***	858	2046	908	-	2071	±10 / ±5
	90	968			1005		922		982		1032	-		
	100	1044			1080		998		1058		1108	-		
Steel SECURE	80	868	2040	54	900	2065	820	2025	880	2055	930	-	2080	±10 / ±5
	90	968			1000		920		980		1030	-		
	100	1068			1100		1020		1080		1130	-		
Steel SAFE	80	868	2037	54	900	2065	820	2023***	880	2053	930	-	2078	±10 / ±5
	90	968			1000		920		980		1030	-		
	100	1068			1100		1020		1080		1130	-		

* for Granite class C H₃=2032

** Project (BIS and Premium) requires enlarging the wall opening S₀ by 30 mm and Ho by 15 mm (dimension tolerance +10 mm/ +5 mm)

Other Project door frame sizes, see drawing on page 188.

*** Steel threshold decreases given dimension by 16 mm.

EXTERNAL DOORS

TABLE 7

	SIZE	S ₃	H ₃	D ₃	S ₀	H ₀	O ₃	O _w	S _B	H _B	S ₂	H ₂	T _{sw}
Steel SAFE	80	868	2037	54	900	2065	820	2023*	880	2053	930	2078	±10 / ±5
	90	968			1000		920		980		1030		
	100	1068			1100		1020		1080		1130		
Steel SAFE with Thermo door frame	80	868	2037	54	900	2065	822	2023*	882	2053	932	2078	±10 / ±5
	90	968			1000		922		982		1032		
	100	1068			1100		1022		1082		1132		
Steel ENERGY PROTECT	80	868	2037	66	900	2065	822	2023*	882	2053	932	2078	±10 / ±5
	90	968			1000		922		982		1032		
	100	1068			1100		1022		1082		1132		

* Steel threshold decreases given dimension by 16 mm.

Door dimensions tables

POLISH NORM (PN)

SLIDING SYSTEMS, FOLDING DOORS

TABLE 8

	SIZE	S _s	H _s	D _s	S _o	H _o	O _s	O _w	H _z	M _s (6)/(8)	M _c	B _G	T _{sw}
PORTA sliding system	60	644	2030	40	680	2060	602	2016	2119	1413	103	60	+20 / +10
	70	744			780		702			1613			
	80	844			880		802			1813			
	90	944			980		902			2013			
	100	1044			1080		1002			2213			

	SIZE	S _s	H _s	D _s	S _o (6)/(8)	H _o	O _s (6)	O _s (8)	O _w	H _z	M _s (6)/(8)	M _c	T _{sw}
ALU sliding system	60	744	2030	40	680/640	2060	602	560	2016	2114	1448	68	+20 / +10
	70	844			780/740		702	660			1648		
	80	944			880/840		802	760			1848		
	90	1044			980/940		902	860			2048		
	110	2 x 644			1220/1180		1145	1104			2452		
	130	2 x 744			1420/1380		1345	1304			2852		
	150	2 x 844			1620/1580		1545	1504			3252		
	170	2 x 944			1820/1780		1745	1704			3652		

	SIZE	S _s	H _s	D _s	S _o (6)/(8)	H _o	O _s	O _w	S _B	H _B	S _z (6)	S _z (8)	H _z (6)/(8)	T _{sw}
ALFA system	60	644	2000	40	680	2060	460	2016	646	2043	746	786	2088/2108	+20 / +10
	70	744			560		746		846		886			
	80	844			660		846		946		986			
	90	944			760		946		1046		1086			
	100	1044			860		1046		1146		1186			
BETA system	60	588	1990	40	680	2070	450	2016	646	2050	746	786	2088/2108	+20 / +10
	70	688			550		746		846		886			
	80	788			650		846		946		986			
	90	888			750		946		1046		1086			

	SIZE	S _s	H _s	D _s	S _o *	H _o *	O _s	O _w	S _B	H _B	S _z (6)	S _z (8)	H _z (6)/(8)	S _C	H _C	T _{sw}
COMPACT pocket door system - single	60	644	2030	40	660	2065	600	2018	654	2040	744	784	2090 / 2110	1355	2130	+5 / +10
	70	744			700		754		844		884	1555				
	80	844			800		854		944		984	1755				
	90	944			900		954		1044		1084	1955				
	100	1044			1000		1054		1144		1184	2155				
COMPACT pocket door system - double	2 x 60	644	2030	40	1265	2065	1214	2018	1258	2040	1358	1398	2090 / 2110	2610	2130	+5 / +10
	2 x 70	744			1465		1414		1458		1558	1598		3010		
	2 x 80	844			1665		1614		1658		1758	1798		3410		
	2 x 90	944			1865		1814		1858		1958	1998		3810		
	2 x 100	1044			2065		2014		2058		2158	2198		4210		

* For COMPACT pocket door system, H_o and S_o sizes refer to opening dimension of steel cassette to be installed with wood-based door frame.

	SIZE	S _{s1}	S _{s2}	H _s	D _s	S _o	H _o	M _s	T _{sw}
Sliding system Porta BLACK - double	70+70	744	744	2090	40	1425	2060	4000	±10 / ±5
	80+70	844	744			1525			
	80+80	844	844			1625			
	90+70	944	744			1625			
	90+80	944	844			1725			
	90+90	944	944			1825			
	100+70	1044	744			1725			
	100+80	1044	844			1825			
	100+90	1044	944			1925			
	100+100	1044	1044			2025			

	SIZE	S _s	H _s	D _s	S _o	H _o	M _s	T _{sw}
BLACK sliding system*	70	744	2090	40	680	2060	2000	±10 / ±5
	80	844			780			
	90	944			880			
	100	1044			980			
SLIDE sliding system	70	744	2200	40	680	2060	2010	±10 / ±5
	80	844			780			
	90	944			880			
	100	1044			980			
EFEKT sliding system	90	944	2230	40	680	2060	1665	-10 / ±50
	100	1044			780		1865	
	110	1144			880		2065	

* In case of installing different door leaf than PORTA BLACK, wall opening should be decreased by 60 mm

	SIZE	S _s	H _s	D _s	S _o	H _o	O _s	O _w	S _B	H _B	S _z	H _z	S _C	H _C	T _{sw}
Frameless system	70	744	2030	40	1580	2110	726	2036	823	2067	1560	2101	1580	2110	+10 / +10
	80	844			1780		826		1760		1780				
	90	944			1980		926		1960		1980				

Door dimensions tables - height '220'

POLISH NORM (PN)

INTERNAL DOORS WITH WOODEN DOOR FRAMES

TABLE 9

DOOR FRAME TYPE	SIZE	S _s	H _s	D _s	S _o	H _o	O _s	O _w	S _b	H _b	S _{z(6)}	S _{z(8)}	H _z	T _{sw}
PORTA SYSTEM	60	644	2230	40	680	2260	602	2216	646	2238	746	786	architrave (6) / (8) 2288 / 2308	+20 / +10
	70	744			780		702		746		846	886		
	80	844			880		802		846		946	986		
	90	944			980		902		946		1046	1086		
	100	1044			1080		1002		1046		1146	1186		
PORTA SYSTEM ELEGANCE	60	618	2217	40	690	2260	602	2216	646	2238	-	786	2308	+10 / +10
	70	718			790		702		746		-	886		
	80	818			890		802		846		-	986		
	90	918			990		902		946		-	1086		
	100	1018			1090		1002		1046		-	1186		
PORTA SYSTEM ELEGANCE 90 degrees	60	618	2217	40	690	2260	602	2216	646	2238	-	786	2308	+10/+10
	70	718			790		702		746		-	886		
	80	818			890		802		846		-	986		
	90	918			990		902		946		-	1086		
	100	1018			1090		1002		1046		-	1186		
PORTA SYSTEM with reversed rebate	60	639	2227	40	720	2280	626	2228	691	2261	-	831	2330	±10/±5
	70	739			820		726		791		-	931		
	80	839			920		826		891		-	1031		
	90	939			1020		926		991		-	1131		
	100	1039			1120		1026		1091		-	1231		

NOTE: S_z and H_z dimensions of door frame in Natural veneers are given with tolerance -1 mm / +3 mm.

*Dimension S_z and H_z measured on the wider side of the door leaf. They are the same as dimensions of doors with PSE

INTERNAL DOORS WITH STEEL DOOR FRAMES

TABLE 10

DOOR FRAME TYPE	SIZE	S _s	H _s	D _s	S _o	H _o	O _s	O _w	S _b	H _b	S _z	H _z	T _{sw}
steel PORTA SYSTEM	60	644	2230	40	675	2255	596	2216	646	2241	736	2286	±10/±5
	70	744			775		696		746		836		
	80	844			875		796		846		936		
	90	944			975		896		946		1036		
	100	1044			1075		996		1046		1136		
steel PORTA SYSTEM ELEGANCE*	60	618	2217	40	675	2255	596	2216	646	2241	736	2286	±10/±5
	70	718			775		696		746		836		
	80	818			875		796		846		936		
	90	918			975		896		946		1036		
	100	1018			1075		996		1046		1136		

*If the back of the hinge does not fit in a wall opening, a little wall chasing has to be made.

PORTA GLASS DOOR

TABLE 11

DOOR FRAME TYPE	SIZE	S _s	H _s	D _s	S _o	H _o	O _s	O _w	S _b	H _b	S _{z(6)}	S _{z(8)}	H _z	T _{sw}
PORTA SYSTEM	60	618	2016	8	680	2060	602	2016	646	2038	746	786	architrave (6) / (8) 2088/2108	+20/+10
	70	718			780		702		746		846	886		
	80	818			880		802		846		946	986		
	90	918			980		902		946		1046	1086		
Corner profile - LARGE (concrete wall)	60	618	2016	8	675	2055	596	2016	656	2046	706	-	2071	±10/±5
	70	718			775		696		756		806	-		
	80	818			875		796		856		906	-		
	90	918			975		896		956		1006	-		
Corner profile - LARGE (plasterboard wall)	60	618	2016	8	685	2055	596	2016	680	2046	706	-	2071	+10/+5
	70	718			785		696		780		806	-		
	80	818			885		796		880		906	-		
	90	918			985		896		980		1006	-		
Adjustable steel PS „with sharp edges“	60	618	2016	8	700	2070	596	2016	679	2058	736	-	2086	-10/-5
	70	718			800		696		779		836	-		
	80	818			900		796		879		936	-		
	90	918			1000		896		979		1036	-		
Steel Porta System	60	618	2016	8	675	2055	596	2016	646	2041	736	-	2086	±10/±5
	70	718			775		696		746		836	-		
	80	818			875		796		846		936	-		
	90	918			975		896		946		1036	-		

NOTES:

- Dimensions tolerance according to PN: to 1 m ±1mm, above 1 m ±2mm.
- Side door panels for rebated door sets are available in Natural Veneer in size '40', S_s=444, H_s=2030.
- Door frames are designed to be installed on finished floor level. For steel door frames there is a possibility to order them in lengthen option +30 mm (to be mounted under floor level). In this case sizes H_o and H_z are enlarged by 30 mm (level -30).
- Given dimension refers to internal door leaves, both rebated and sliding
- PORTA SYSTEM integrated with an upper transom. Dimensions H_o, H_b, H_z +302 mm.
- Project (BIS and Premium) requires enlarging the wall opening S_o by 30 mm and H_o by 15 mm (dimension tolerance +10 mm / +5 mm)

HEIGHT ,220' IS AVAILABLE IN CHOSEN COLLECTIONS:

- 4 Elements
- PORTA VECTOR
- PORTA ART DECO
- PORTA DESIRE
- PORTA OSLO
- Nature OSLO
- Nature CLASSIC
- Nature LINE
- Nature VECTOR

Door dimensions tables

CZECH NORM/GERMAN NORM (CN/DIN)

INTERNAL DOORS

TABLE 12

CN/DIN	SIZE	S _s	H _s	D _s	S ₀	H ₀	O _s	O _w	S _b	H _b	S _z (6)	S _z (8)	H _z (6) / (8)	T _{s,w}
Minimax 60 mm Minimax 100 mm MDF in Natural Veneer	60	648/610	1985	40	715/680	2030	606/569	1971	694/657	2015	804/767	-	2070	+20 / +10
	70	748/735			815/805		706/694		794/782		904/892	-		
	80	848/860			915/930		806/819		894/907		1004/1017	-		
	90	948/985			1015/1055		906/944		994/1032		1104/1142	-		
	100	1048/-			1115/-		1006/-		1094/-		1204/-	-		
PORTA SYSTEM door frame	60	648/610	1985	40	685/650	2015	606/567	1971	650/611	1993	750/711	790/751	profile (6) / (8) 2043/2063	+20 / +10
	70	748/735			785/775		706/692		750/736		850/836	890/876		
	80	848/860			885/900		806/817		850/861		950/961	990/1001		
	90	948/985			985/1025		906/942		950/986		1050/1086	1090/1126		
	100	1048/-			1085/-		1006/-		1050/-		1150/-	1190/-		
	110	1148/-			1185/-		1106/-		1150/-		1250/-	1290/-		
PORTA SYSTEM ELEGANCE / LEVEL door frames	60	622/584	1972	40	695/660	2015/ LEVEL 2025	606/567	1971	650/611	1993/ LEVEL 2001	-	790/751	-2063/ LEVEL 2183/2983 Upper panel (20)/(100)	+20 / +10
	70	722/709			795/785		706/692		750/736		-	890/876		
	80	822/834			895/910		806/817		850/861		-	990/1001		
	90	922/959			995/1035		906/942		950/986		-	1090/1126		
	100*	1022/-			1095/-		1006/-		1050/-		-	1190/-		
PORTA SYSTEM ELEGANCE 90° door frames	60	622/584	1972	40	695/660	2015	606/567	1971	650/611	1993	-	790/751	-2065	+20/+10
	70	722/709			795/785		706/692		750/736		-	890/876		
	80	822/834			895/910		806/817		850/861		-	990/1001		
	90	922/959			995/1035		906/942		950/986		-	1090/1126		
	100	1022/-			1095/-		1006/-		1050/-		-	1190/-		
se zárubní PORTA SYSTEM with a reversed rebate*	60	643/-	1982	40	725/-	2035	630/-	1983	695/-	2015	-	835/-	-2085	±10/±5
	70	743/-			825/-		730/-		795/-		-	935/-		
	80	843/-			925/-		830/-		895/-		-	1035/-		
	90	943/-			1025/-		930/-		995/-		-	1135/-		
	100	1043/-			1125/-		1030/-		1095/-		-	1235/-		
RENOVA** door frame	60	648/-	1985	40	600/561	1971	562/-	1949	588/-	1962	750/-	-	2043	+15* -6
	70	748/-			700/686		662/-		688/-		850/-	-		
	80	848/-			800/811		762/-		788/-		950/-	-		
	90	948/-			900/936		862/-		888/-		1050/-	-		
	100	1048/-			1000/-		962/-		988/-		1150/-	-		
	110	1148/-			1100/-		1062/-		1088/-		1250/-	-		
Corner profile door frame -SMALL PLUS	60	648/610	1985	40	655/615	1995	600/561	1968	633/594	1985	710/671	-	2023	±10 / ±5
	70	748/735			755/740		700/686		733/719		810/796	-		
	80	848/860			855/865		800/811		833/844		910/921	-		
	90	948/985			955/990		900/936		933/969		1010/1046	-		
	100	1048/-			1055/-		1000/-		1033/-		1110/-	-		
Corner profile door frame -LARGE for concrete walls and stainless steel LARGE folding	60	648/610	1985	40	680/640	2010	600/561	1968	660/621	1998	710/671	-	2023	±10 / ±5
	70	748/735			780/765		700/686		760/746		810/796	-		
	80	848/860			880/890		800/811		860/871		910/921	-		
	90	948/985			980/1015		900/936		960/996		1010/1046	-		
	100	1048/-			1080/-		1000/-		1060/-		1110/-	-		
Corner profile door frame -LARGE for plasterboard walls	60	648/610	1985	40	685/645	2010	600/561	1968	684/645	1998	710/671	-	2023	+10 / +5
	70	748/735			785/770		700/686		784/770		810/796	-		
	80	848/860			885/895		800/811		884/895		910/921	-		
	90	948/985			985/1020		900/936		984/1020		1010/1046	-		
	100	1048/-			1085/-		1000/-		1084/-		1110/-	-		
ADJUSTABLE door frame	60	648/610	1985	40	695/655	2015	600/561	1968	674/635	2005	720/681	-	2028	-10 / -5
	70	748/735			795/780		700/686		774/760		820/806	-		
	80	848/860			895/905		800/811		874/885		920/931	-		
	90	948/985			995/1030		900/936		974/1010		1020/1056	-		
	100	1048/-			1095/-		1000/-		1074/-		1120/-	-		
Adjustable steel door frame, non-rebated	60	622/584	1972	40	695/655	2017	600/561	1970/1968	675/635	1995/1993	740/701	-	2040/2038	-10 / -5
	70	722/709			795/780		700/686		775/760		840/826	-		
	80	822/834			895/905		800/811		875/885		940/951	-		
	90	922/959			995/1030		900/936		975/1010		1040/1076	-		
	100	1022/-			1095/-		1000/-		1075/-		1140/-	-		
Steel PORTA SYS- TEM ELEGANCE***	60	622/584	1972	40	680/640	2010	600/561	1970/1968	650/611	1995/1993	740/701	-	2040/2038	±10 / ±5
	70	722/709			780/765		700/686		750/736		840/826	-		
	80	822/834			880/890		800/811		850/861		940/951	-		
	90	922/959			980/1015		900/936		950/986		1040/1076	-		
	100	1022/-			1080/-		1000/-		1050/-		1140/-	-		
Corner profile - LARGE, non-rebated, for concrete walls***	60	622/584	1972	40	680/640	2010	600/561	1970/1968	660/620	2000	740/701	-	2040/2038	±10 / ±5
	70	722/709			780/765		700/686		760/745		840/826	-		
	80	822/834			880/890		800/811		860/870		940/951	-		
	90	922/959			980/1015		900/936		960/995		1040/1076	-		
	100	1022/-			1080/-		1000/-		1060/-		1140/-	-		
	110	1122/-			1180/-		1100/-		1160/-		1240/-	-		
Corner profole LARGE, non-rebated for plasterboard walls	60	622/584	1972	40	685/646	2010	600/561	1970/1968	684/645	2012	740/701	-	2040/2038	+10 / +5
	70	722/709			785/771		700/686		784/770		840/826	-		
	80	822/834			885/896		800/811		884/895		940/951	-		
	90	922/959			985/1021		900/936		984/1020		1040/1076	-		
	100	1022/-			1085/-		1000/-		1084/-		1140/-	-		
	110	1122/-			1185/-		1100/-		1184/-		1240/-	-		
Steel Adjustable PS with sharp edges*	60	648/610	1985	40	705/665	2023	600/561	1968	684/645	2010	740/701	-	2038	-10 / -5
	70	748/735			805/790		700/686		784/770		840/826	-		
	80	848/860			905/915		800/811		884/895		940/951	-		
	90	948/985			1005/1040		900/936		984/1020		1040/1076	-		
	100	1048/-			1105/-		1000/-		1084/-		1140/-	-		
Steel PORTA SYSTEM	60	648/610	1985	40	680/640	2010	600/561	1970/1968	650/611	1995/1993	740/701	-	2040/2038	±10/±5
	70	748/735			780/765		700/686		750/736		840/826	-		
	80	848/860			880/890		800/811		850/861		940/951	-		
	90	948/985			980/1015		900/936		950/986		1040/1076	-		
	100	1048/1110			1080/1140		1000/1061		1050/1111		1140/1201	-		

* only PORTA SYSTEM ELEGANCE

** S_f/H₀ width/height of clear opening of old steel frame. T_{s,w} - tolerance +15 mm depends on a construction of the old door frame.

Door dimensions tables

CZECH NORM/GERMAN NORM (CN/DIN)

EXTERNAL DOORS

TABLE 13

CN	SIZE	S _s	H _s	D _s	S _o	H _o	O _s	O _w	S _b	H _b	S _z (6)	S _z (8)	H _z	T _{sw}
Steel SAFE	80	848	1985	53	880	2010	800	1969**	860	1999	910	-	2024	±10/±5
	90	948			980		900		960		1010	-		
	100	1048			1080		1000		1060		1110	-		

FOLDING DOORS

TABLE 14

CN/DIN	SIZE	S _s	H _s	D _s	S _o	H _o	O _s	O _w	S _b	H _b	S _z (6)	S _z (8)	H _z (6,8)	T _{sw}
ALFA	60	647/609	1955	40	685/650	2015	465/425	1971	650/611	1993	750/711	790/751	profile (6)/(8) 2043/2063	+20/+10
	70	747/734			785/775		565/550		750/736		850/836	890/876		
	80	847/859			885/900		665/675		850/861		950/961	990/1001		
	90	947/985			985/1025		765/800		950/986		1050/1086	1090/1126		
	100	1047/-			1085/-		865/-		1050/-		1150/-	1190/-		
BETA	60	592/554	1945	40	685/650	2005	455/415	1971	650/611	2004	750/711	790/751	profile (6)/(8) 2043/2063	+20/+10
	70	692/680			785/775		555/540		750/736		850/836	890/876		
	80	792/806			885/900		655/665		850/861		950/961	990/1001		
	90	892/930			985/1025		755/790		950/986		1050/1086	1090/1126		

SLIDING SYSTEMS

TABLE 15

CN/DIN	SIZE	S _s	H _s	D _s	S _o	H _o	O _s	O _w	H _z	M _s (6,8)	M _g	B _g	T _{sw}
PORTA sliding system PORTA	60	644	1985	40	684	2015	606	1971	2074	1413	103	60	+20/+10
	70	744			784		706			1613			
	80	844			884		806			1813			
	90	944			984		906			2013			
	100	1044			1084		1006			2213			

CN	SIZE	S _s	H _s	D _s	S _o	H _o	O _s	O _w	S _b	H _b	S _z (6)	S _z (8)	H _z (6,8)	S _c	H _c	T _{sw}
COMPACT sliding system - single	60	644	1985	40	660	2020	600	1973	654	1995	744	784	"2045/ 2065"	1355	2085	+10/+5
	70	744			760		700		844		884	1555				
	80	844			860		800		944		984	1755				
	90	944			960		900		1044		1084	1955				
	100	1044			1060		1000		1144		1184	2155				
COMPACT sliding system - double	2x60	2x 644	1985	40	1300	2020	1249	1973	1293	1995	1393	1433	"2045/ 2065"	2845	2085	+10/+5
	2x70	2x 744			1500		1449		1493		1593	1633		3045		
	2x80	2x 844			1700		1649		1693		1793	1833		3445		
	2x90	2x 644			1900		1849		1893		1993	2033		3845		
	2x100	2x 1044			2100		2049		2093		2193	2233		4245		

* For COMPACT pocket door system, H_o and S_o sizes refer to opening dimension of steel cassette to be installed with wood-based door frame.

CN	SIZE	S _s	H _s	D _s	S _o	H _o	M _s	T _{sw}
BLACK sliding system/ SLIDE sliding system	70	744	2045 Black/ 2155 Slide	40	680	2015	2000	+10/+5
	80	844			780			
	90	944			880			
	100	1044			980			

CN	SIZE	S _s	H _s	D _s	S _o	H _o	O _s	O _w	S _b	H _b	S _z	H _z	S _c	H _c	T _{sw}
Frameless sliding system	70	744	1985	40	1580	2070	726	1991	823	2022	1560	2056	1580	2070	+20/+10
	80	844			1780		826		923		1760		1780		
	90	944			1980		926		1023		1960		199980		

PORTA HIDE DOORS

TABLE 16

CN	SIZE	S _s	H _s	D _s	S _o	H _o	O _s	O _w	S _b	H _b
PORTA HIDE non-rebated (opening outward)	70	722	1972	40	804	2025	707	1972	791	2014
	80	822			904		807		891	
	90	922			1004		907		991	
PORTA HIDE with reversed rebate (inward opening)	70	722	1982	40	804	2035	707	1982	791	2024
	80	822			904		807		891	
	90	922			1004		907		991	

Door dimensions tables

CZECH NORM/GERMAN NORM (CN/DIN)

TECHNICAL DOORS

TABLE 17

CN	SIZE	S _s	H _s	D _s	S ₀	H ₀	O _s	O _w	S _b	H _b	S ₂ (6)	S ₂ (8)	H ₂ (6)	H ₂ (8)	T _{sw}
PORTA SILENCE R _w =37 dB adjustable rebated	80	848	1985	49÷50	885	2015	806	1971	854	1995	951	991	2044	2064	+20/+10
	90	948			985		906		954		1051	1091			
	100	1048			1085		1006		1054		1151	1191			
PORTA SILENCE R _w =37 dB adjustable non-rebated	80	822	1972	49÷50	885	2015	806	1971	854	1995	951	991	2044	2064	+20/+10
	90	922			985		906		954		1051	1091			
	100	1022			1085		1006		1054		1151	1191			
PORTA SILENCE R _w =37 dB fixed, rebated	80	848	1985	49÷50	955	2045	806	1971	926	2031	1031	1071	2080	2100	±10/±5
	90	948			1055		906		1026		1131	1171			
	100	1048			1155		1006		1126		1231	1271			
PORTA SILENCE R _w =37 dB fixed, non-rebated	80	822	1972	49÷50	955	2045	806	1971	926	2031	1031	1071	2080	2100	±10/±5
	90	922			1055		906		1026		1131	1171			
	100	1022			1155		1006		1126		1231	1271			
PORTA SILENCE R _w =37 dB rebated, with a steel door frame	80	848	1985	49÷50	880	2010	800	1968	860	1998	910	-	2023	-	±10/±5
	90	948			980		900		960		1010	-			
	100	1048			1080		1000		1060		1110	-			
PORTA SILENCE R _w =37 dB non-rebated, with a steel door frame	80	822	1972	49÷50	880	2010	800	1968	860	1998	910	-	2023	-	+10/+5
	90	922			980		900		960		1010	-			
	100	1022			1080		1000		1060		1110	-			
Ei30 s (fixed) MDF	60	648	1985	44÷45	755	2045	606	1971	726	2031	831	871	2080	2100	±10/±5
	70	748			855		706		826		931	971			
	80	848			955		806		926		1031	1071			
	90	948			1055		906		1026		1131	1171			
	100	1048			1155		1006		1126		1231	1271			
	60	648			680		600		660		710	-			
Ei 30 wooden, with corner profile frame - LARGE	70	748	1985	44÷45	780	2010	700	1968	760	1998	810	-	2023	-	±10/±5
	80	848			880		800		860		910	-			
	90	948			980		900		960		1010	-			
	100	1048			1080		1000		1060		1110	-			
	80	848			880		800		860		910	-			
AGAT, OPAL*	90	948	1985	44÷45	980	2010	900	1968**	960	1998	1010	-	2023	-	±10/±5
	100	1048			1080		1000		1060		1110	-			
	80	848			880		800		860		910	-			
QUARTZ GRANITE cl. C	90	948	1985	44÷45	980	2010	900	1968	960	1998	1010	-	2023	-	±10/±5
	100	1048			1080		1000		1060		1110	-			
	80	848			880		800		860		910	-			
GRANITE RC3, EXTREME - steel door frame	90	948	1985	50	880	2010	800	1968	860	1998	910	-	2023	-	+10/+5
	100	1048			980		900		960		1010	-			
	80	848			885		806		854		951	991			
GRANITE RC3, EXTREME - PS	90	948	1985	50	985	2015	906	1971	954	1995	1051	1091	2044	2064	+20/+10
	100	1048			1085		1006		1054		1151	1191			
	60	648			653		600		633		710	-			
Steel BASIC and Steel BASIC PLUS with corner profile steel door frame - SMALL PLUS	70	748	1985	40	753	1997- Basic 2001- Basic PLUS	700	1970	733	1987	810	-	2025- Basic 2029- Basic PLUS	-	±10/±5
	80	848			853		800		833		910	-			
	90	948			953		900		933		810	-			
	100	1048			1053		1000		1033		1010	-			
	60	648			653		600		633		710	-			

* Project (BIS and Premium) requires enlarging the wall opening S₀ by S₀ by 30 mm and H₀ o 15 mm (dimension tolerance ±10 mm / ±5 mm).

Other Project door frame sizes, see drawing on page 205.

** Steel threshold LARGE decreases given dimension by 16 mm.

OPTIONS OF INSTALLATION - MINIMAX DOOR FRAMES

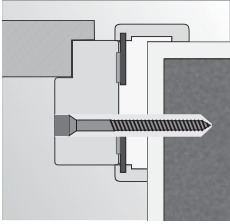

installation on a concrete wall with mounting foam and anchors

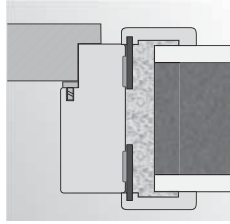

installation on a concrete wall with expanding foam

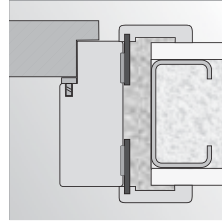

installation on a plasterboard wall with expanding foam

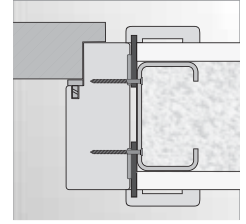

installation on a plasterboard wall with screws

OPTIONS OF INSTALLATION - CORNER PROFILE DOOR FRAMES

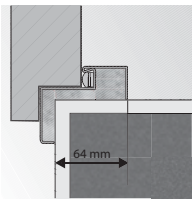

Corner profile door frame - SMALL PLUS

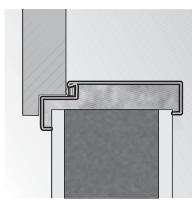

installation without additional anchoring elements

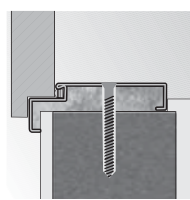

Corner profile - LARGE door frame installation with dowels

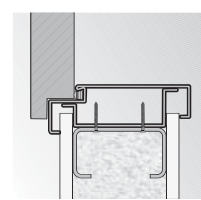

Corner profile - LARGE door frame installation on plasterboard wall

OPTIONS OF INSTALLATION - ADJUSTABLE DOOR FRAME, ADJUSTABLE PS WITH 'SHARP EDGES'

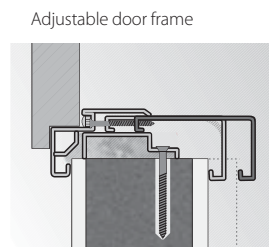

Adjustable door frame

wall thickness adjustment range

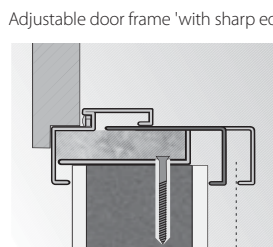

Adjustable door frame 'with sharp edges'

wall thickness adjustment range

EXAMPLES OF INSTALLATION - HIDE DOORS

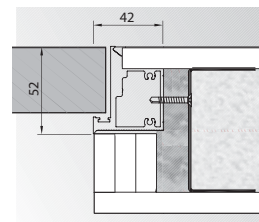

non-rebated (outward opening)

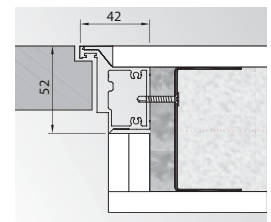

reversed rebated (inward opening)

RETRO MODULE (WITH PORTA SYSTEM DOOR FRAME)

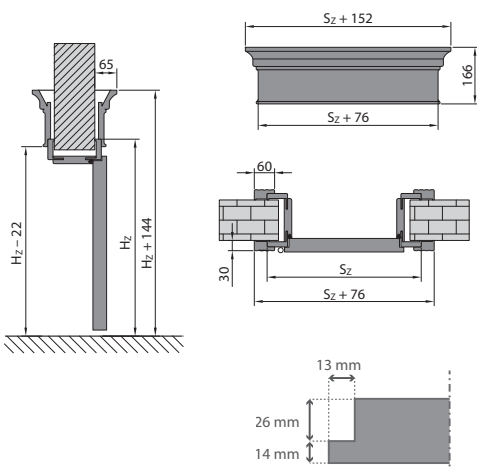

PREPARATION OF THE OPENING FOR INSTALLATION OF THE NON-REBATED DOOR FRAME

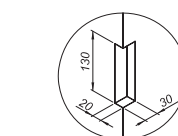

*middle forging in the wall should be done for frame with three hinges

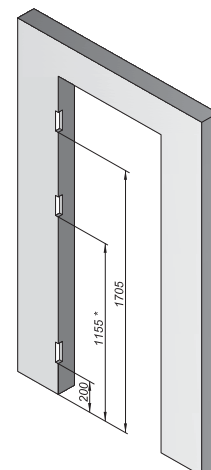

Durability levels of finishes / finishes charts

CHECK THE DURABILITY LEVELS OF OUR FINISHES AND CHOOSE THE RIGHT ONE FOR YOU.

STANDARD

Basic durability level which provides the possibility of long-term use in household.

PREMIUM

A perfect combination of design and guaranteed high quality. Indications for use: residential buildings and offices.

EXTREME

High durability level which guarantees door protection from intensive usage. Indications for use - places with heavy foot traffic, where hundreds of people pass daily.

STANDARD PLUS

Improved STANDARD class with enhanced parameters of resistance to abrasion and humidity.

PREMIUM PLUS

Durability level that combines great practicality and elegance in any place where doors are directly exposed to long-term external factors. Suggested indications for use: hotels, public buildings and offices.

Standard Paint

1 layer of painting, safe for allergy sufferers, small children and the environment.



Standard UV Paint

2 layers of UV-hardened Paint. It has properties like Standard Paint and additionally colour durability thanks to UV hardening.

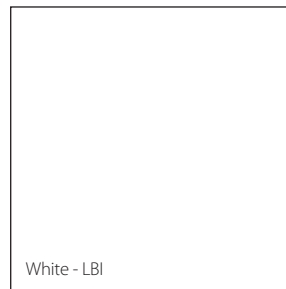

Finish available in the PORTA FACTOR collection.

Premium UV Paint

3 layers of UV - hardened paint. It has properties like UV Paint Standard and in addition satin smoothness and high resistance to abrasion, scratches, dirt, and easy to keep clean.



Premium Lacquered Veneer

A Veneer that is an alternative to a painted product. It perfectly reflects the properties of the paint coating. It has a painting layer - a base material which, after appropriate processing, is lacquered, ensuring a haptic similar to varnish.

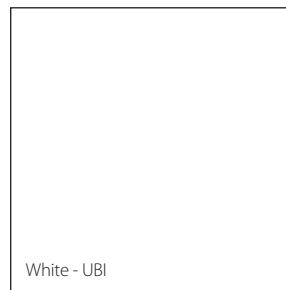

Premium Plus UV Paint

The most durable paint in the PORTA offer. It has the properties of Premium UV Paint, and thanks to the use of a special paint application technology, we have achieved the effect of a satin-smooth surface without visible pores. In addition, the use of colour-hardening technology with UV light makes this finish protected from fingerprints -so-called antifinger effect.

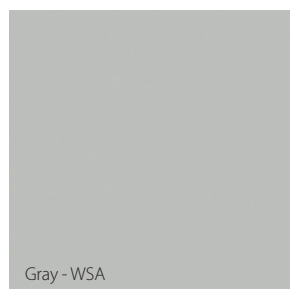

White colour is comparable with RAL 9003
Grey colour is comparable with RAL 7035

Due to technology and use of various materials for door frames and door leaves, there might appear slight difference between them.

At PORTA we do our best to create a perfect colour match of offered doorsets. However due to technology and materials slight differences may appear.

Finishes charts

Portadecor Veneer

This type of finish is an excellent combination of price, performance and the breadth of the available range. The surface of the Veneer is finished with lacquer. It is characterized by a smooth surface with a print.

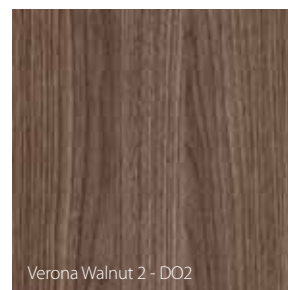
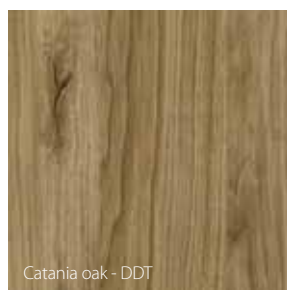
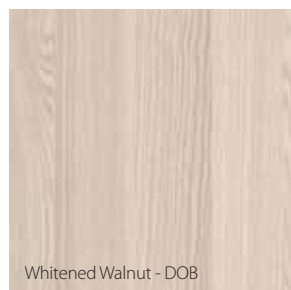
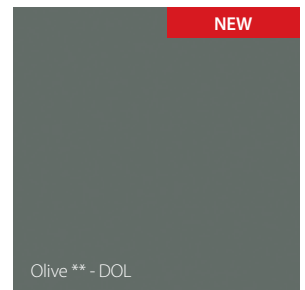

Fiord colour is comparable with NCS:
s 3010-b50g
Olive colour is comparable with NCS:
s 6010 - g10y

** finish available exclusively
in chosen products

SUPER MATT Veneer

This type of finish is PP film, or polypropylene film, which is characterized by increased resistance to abrasion, or scratching. At the same time, it gives the door a silky smooth structure.

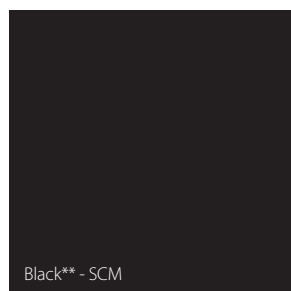

** finish available
in chosen products

Matt Lacquered Veneer

The Veneer is characterized by exceptional durability, surface smoothness, and low porosity. An additional advantage is its protection against fingerprints, the so-called antifinger coating, which significantly affects the quality of use of doors in this finish in everyday life.

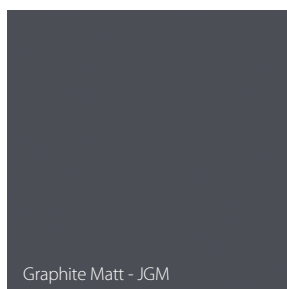

Colour Gray Platinum Matt is comparable
with RAL 7037 / NCS s5502-g

Graphite Matt colour is comparable with RAL
7024 / NCS S8000-N

Colour Cashmere Matt is comparable with
NCS S2005-Y50R / S2005-Y60R

At PORTA we do our best to create a perfect colour match of offered doorsets. However due to technology and materials slight differences may appear.

Finishes charts

Portasynchro 3D Veneer

The finish, which has the characteristics of a Portadecor finish with an additional optical effect, reflects the structure of the wood and gives it a three-dimensional effect.



Wenge White - RNS



Norwegian Pine - RSN



Andersen Pine - RSD



Silver Acacia - RAS

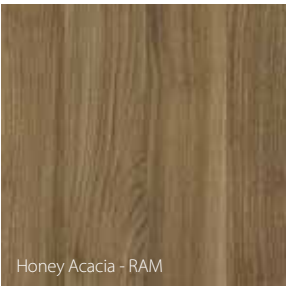

Honey Acacia - RAM

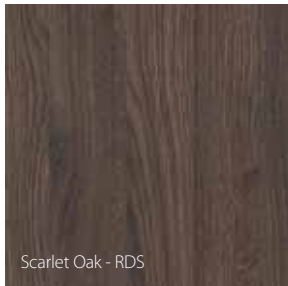

Scarlet Oak - RDS

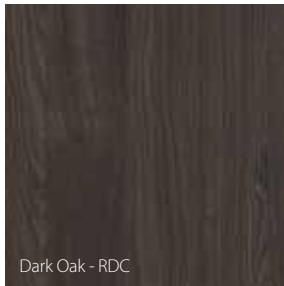

Dark Oak - RDC

At PORTA we do our best to create a perfect colour match of offered doorsets. However due to technology and materials slight differences may appear.

Portaperfect 3D Veneer

A high-quality surface finish imitates the wood grain with a 3D effect that you can feel under your fingers.



Scandinavian Oak - PDN



Siberian Oak - PDY

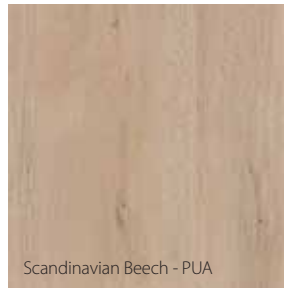

Scandinavian Beech - PUA

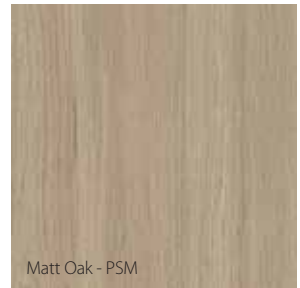

Matt Oak - PSM

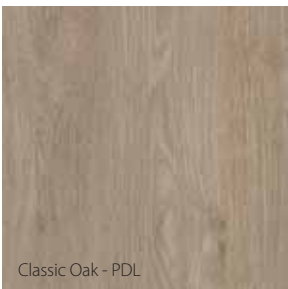

Classic Oak - PDL

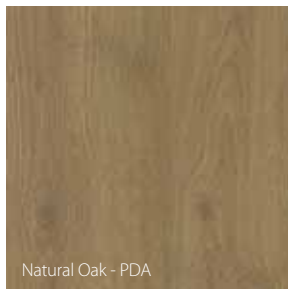

Natural Oak - PDA

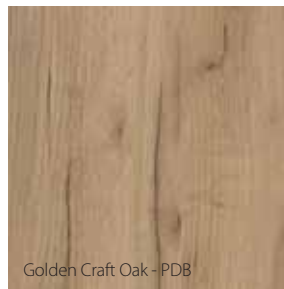

Golden Craft Oak - PDB

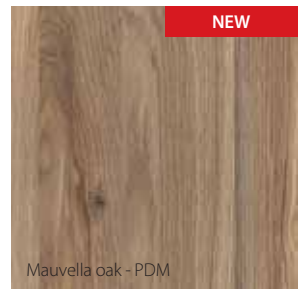

Mauvella oak - PDM

NEW

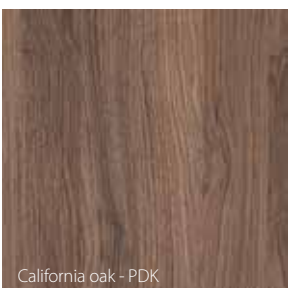

California oak - PDK

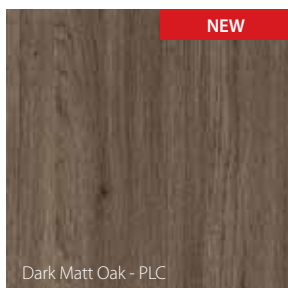

Dark Matt Oak - PLC

NEW

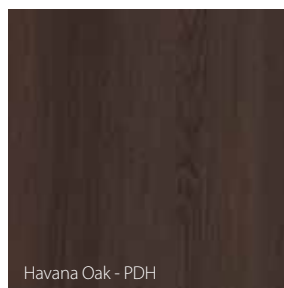

Havana Oak - PDH

Finishes charts

Portalamino Veneer ◆◆◆◆◆◇

It is a type of durable, flexible laminate that visually and to the touch reflects the texture of wood. For additional protection of its surface is applied lamination technology, which affects durability.

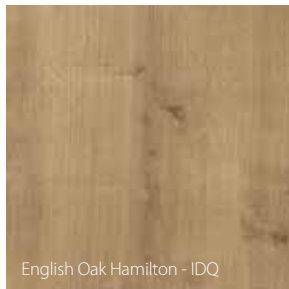

Gladstone/Halifax board ◆◆◆◆◆◆

Very strong and extremely durable finish - highly compressed board with very fine fiber structure. Thanks to its high density, it guarantees high resistance to impacts, abrasion and scratches.

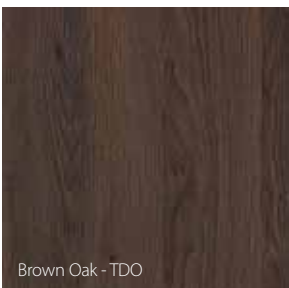
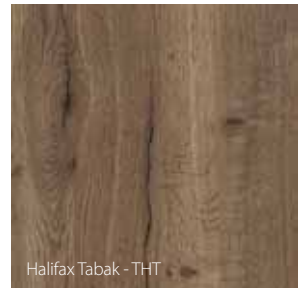
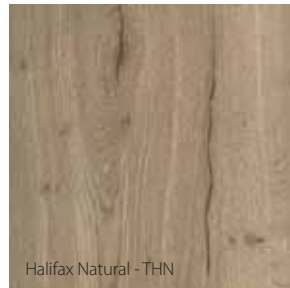
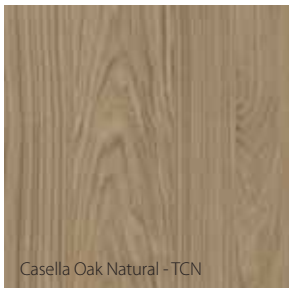
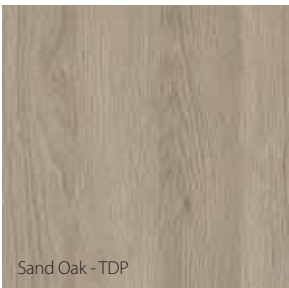

Laminated steel sheet (PVC) ◆◆◆◆◆◆

Steel sheets and decorative foil can imitate natural wood or modern structures. The suggested usage of this solution are places directly exposed to long-term external factors.

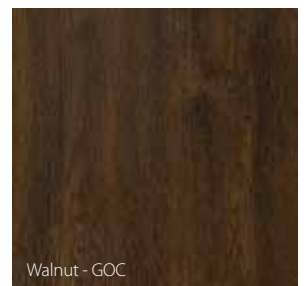
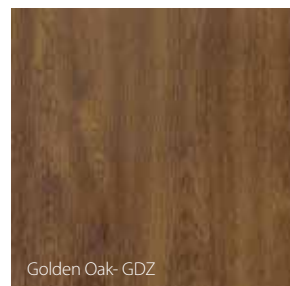







At PORTA we do our best to create a perfect colour match of offered doorsets. However due to technology and materials slight differences may appear.

Finishes charts

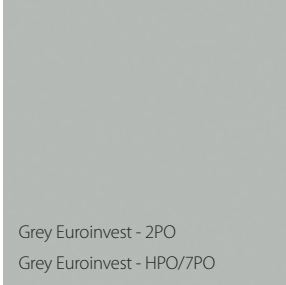
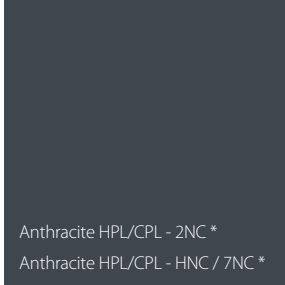
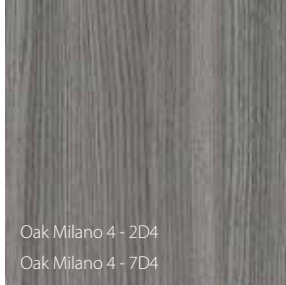
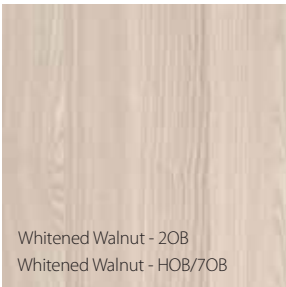
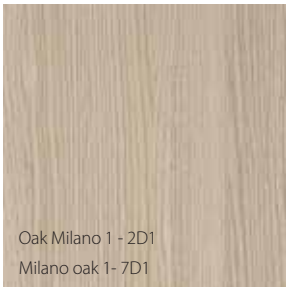
CPL HQ 0,2 laminate ◆◆◆◆◆◆◆◆

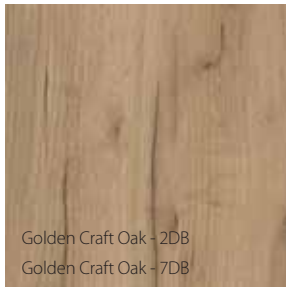
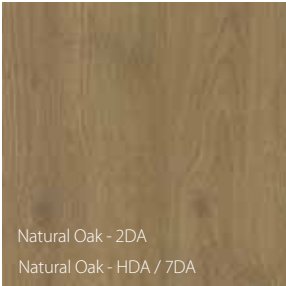
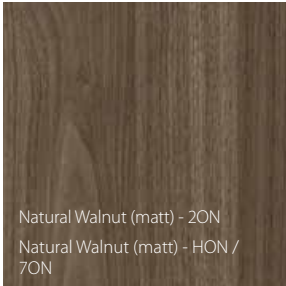
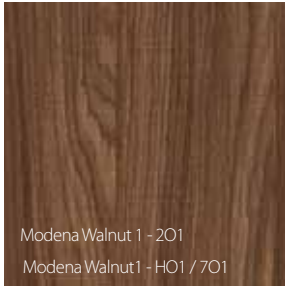
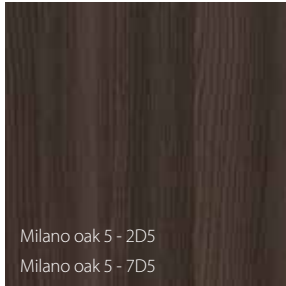
HPL and CPL 0,7 HQ laminate ◆◆◆◆◆◆◆◆

Laminates are characterized by high resistance to scratches, impacts, abrasion and scrapes. Thanks to printing with texture, products with this surface have an additional haptic effect. CPL HQ 0.2 laminate can be used on door leaves and door frames, HPL and CPL HQ 0.7 laminate can only be used on door leaves due to their high hardness. Laminates consist of a decorative layer impregnated with resins and a backing layer that provides flexibility.

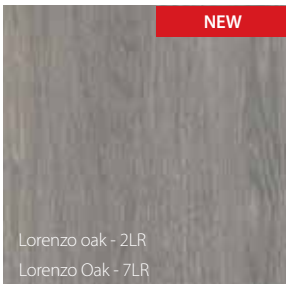
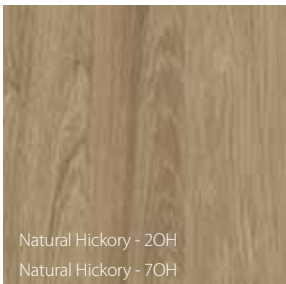
	 <p>White - 2BM White - HBM / 7BM</p>	 <p>Grey Euroinvest - 2PO Grey Euroinvest - HPO/7PO</p>	 <p>Anthracite HPL/CPL - 2NC * Anthracite HPL/CPL - HNC / 7NC *</p>	 <p>Oak Milano 4 - 2D4 Oak Milano 4 - 7D4</p>
GROUP I	 <p>Whitened Walnut - 2OB Whitened Walnut - HOB/7OB</p>	 <p>Oak Milano 1 - 2D1 Milano oak 1 - 7D1</p>	 <p>Sand Beech - 2UP Sand Beech - 7UP</p>	 <p>Golden Craft Oak - 2DB Golden Craft Oak - 7DB</p>
	 <p>Natural Oak - 2DA Natural Oak - HDA / 7DA</p>	 <p>Natural Walnut (matt) - 2ON Natural Walnut (matt) - HON / 7ON</p>	 <p>Modena Walnut 1 - 2O1 Modena Walnut1 - HO1 / 7O1</p>	 <p>Milano oak 5 - 2D5 Milano oak 5 - 7D5</p>
	 <p>Light Concrete - 2US Light Concrete - 7US</p>	 <p>Dark Concrete - 2UC Dark Concrete - 7UC</p>	 <p>Black - 2EC Black - HEC / 7EC</p>	 <p>Structure Dark - 2FC Structure Dark - 7FC</p>
GROUP II	 <p>NEW</p> <p>Lorenzo oak - 2LR Lorenzo Oak - 7LR</p>	 <p>Natural Hickory - 2OH Natural Hickory - 7OH</p>		

Characteristic of HPL and CPL veneers: www.porta.com.pl/dm/charakterystykaHPLCPL.pdf
** HPL/CPL marking is introduced because of dedicated powder Paint Anthracite HPL/CPL.



Natural Veneer

Natural Oak, Ash, Walnut and Matt Oak Veneer are unique finishes in our offer, as their natural colours are varnished only with ecological UV varnish. The solid presentation of the natural colour of the wood and the depth of its grain, nobly refers to nature.

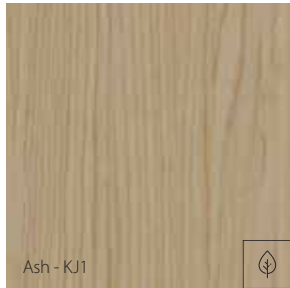

Ash - KJ1

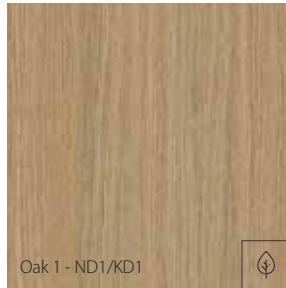

Oak 1 - ND1/KD1

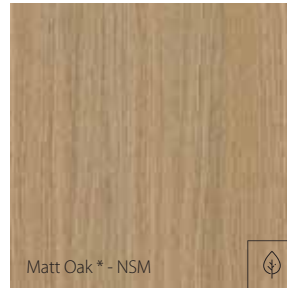

Matt Oak * - NSM

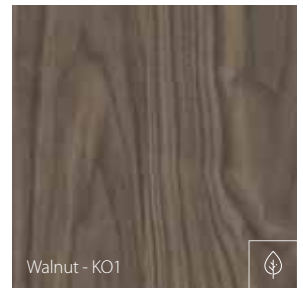

Walnut - KO1

* this finish is available only for 4 ELEMENTS collection - EARTH and PORTA HIDE

Natural Veneer - Select

Natural Veneer 'Select' - is a specially prepared and selected Natural Veneer characterized by high repeatability of the wood grain and colour. Products finished with this type of Veneer meet the high quality standards.

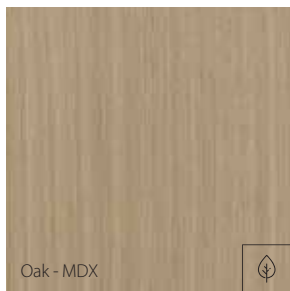

Oak - MDX



Dark Walnut - EQX

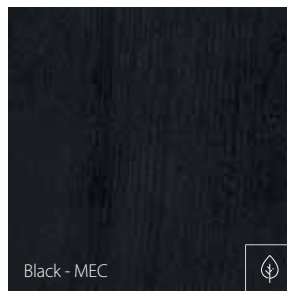

Black - MEC

BLACK COLOUR
IS COMPARABLE TO RAL 9017

Natural Oak Satin Veneer

These veneers are characterized by a variety of colorus, graining, etc. Their properties are the result of natural environment of trees, climate, habitat conditions. Its colour is obtained using staining technology and subsequent varnishing with an environmentally friendly clear varnish. It comes in two varieties: striped, which has a uniform wood grain pattern, and 'flower' (flader), which has a natural, distinct and patterned wood grain pattern.



White Oak - NBI / KBI

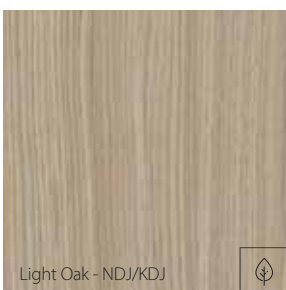

Light Oak - NDJ/KDJ

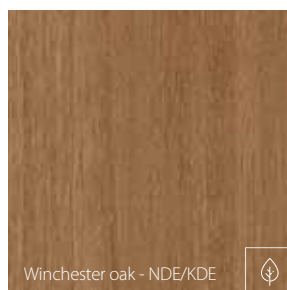

Winchester oak - NDE/KDE

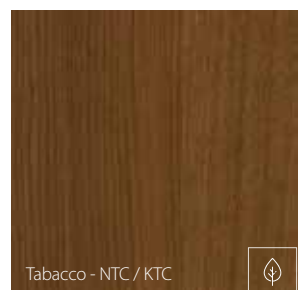

Tabacco - NTC / KTC

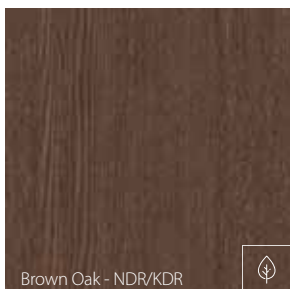

Brown Oak - NDR/KDR

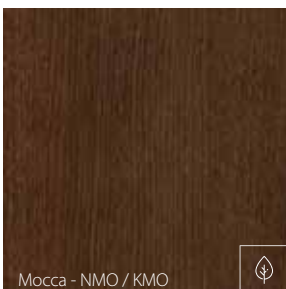

Mocca - NMO / KMO

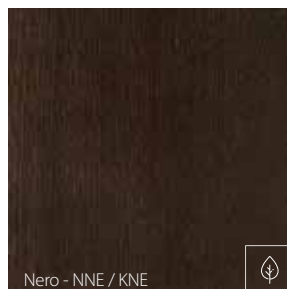

Nero - NNE / KNE

WHITE COLOUR
IS COMPARABLE WITH RAL 9016

Certain Veneer pattern is received thanks to proper wood selection, appropriate Veneer leaf processing and its folding technique.

Finishes key:

N- 'striped' wood grain

K- 'flower' wood grain

Due to the characteristic of natural veneers, differences in colour and graining, might appear on a door leaf. These differences cannot be grounds for complaints. At PORTA we do our best to create a perfect colour match of offered doorsets. However due to technology and materials slight differences may appear.

Finishes charts

Premium Polyester Paint ◆◆◆◆◇◇

The composition of the paint is a resin or mixture of resins in the right proportion, pigments and fillers, and additives. After painting with paint, the parts are heated, as a result, the powder paint is melted, giving a durable coating.

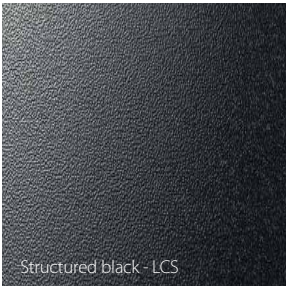

GROUP I				
				
GROUP II		GROUP III		

White colour (LBM) is comparable with RAL 9003
 Grey (LPM) is comparable with RAL 7047
 Brown (LRM) is comparable with RAL 8028
 Beige (LKM) is comparable with RAL 1019
 Black (LCM) is comparable with RAL 9017
 Structured anthracite (LNT) is comparable with RAL 7024

* HPL/CPL marking was introduced considering dedicated Veneer Anthracite HPL/CPL

Coated steel sheet ◆◆◆◆◇◇

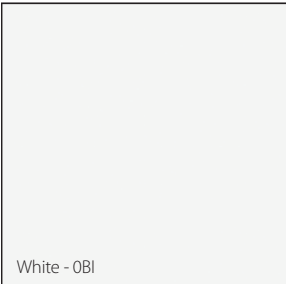
Galvanized steel finished with organic coating based on polyester resins. A very popular solution, aesthetically pleasing and durable.

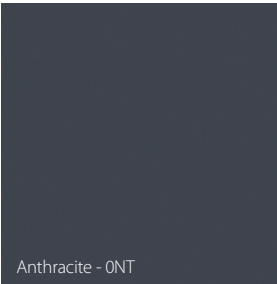
		
--	---	--

Due to the nature of the material used, the colours of the products are similar to those given in the RAL palette.
 White colour is comparable with RAL 9010/
 Grey colour is comparable with RAL 7035
 Anthracite colour is comparable with RAL 7024

At PORTA we do our best to create a perfect colour match of offered doorsets. However due to technology and materials slight differences may appear.

Galvanized steel sheet

It is protected against corrosion by applying a layer of zinc. The zinc coating protects the steel for many years and is maintenance-free, allowing it to be used in the most demanding conditions, exposed to aggressive environmental factors, mainly corrosion.

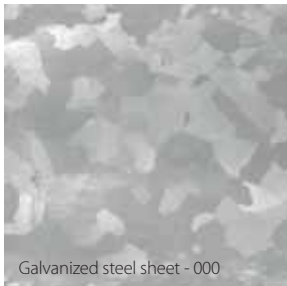

Stainless steel

An excellent material with special physical and chemical properties. Its main feature is extraordinary resistance to corrosion and the harmful effects of acids. Thanks to this property, it can be used in aggressive environments. An important factor responsible for the popularity of this material in industry is its resistance in contact with high temperatures.



Prime Paint



GLASS PANEL TYPES



transparent glass panel



'Chinchilla' glass panel



black glass panel



"frame" glass panel - frosted

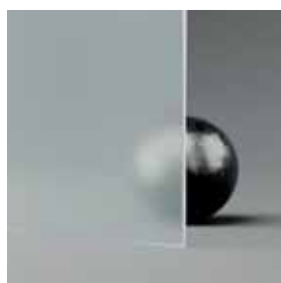

frosted glass panel

At PORTA we do our best to create a perfect colour match of offered doorsets. However due to technology and materials slight differences may appear.

**PERFECTLY MATCHED PAIR.
CHECK OUT PORTA COMPREHENSIVE
SOLUTIONS FOR YOUR HOME!**

PORTA THERMO/ model G.1/ Woodec Turner Oak finish/ **Nature CLASSIC** / model 1.1/ Natural Veneer Satin Light Oak (flower)

NEW

PORTA THERMO steel exterior doors



PORTA THERMO, model G.2, colour Woodec Oak Turner and transoms



Scan QR code
and discover our new collection of exterior doors

PORTA 
THERMO

PORTA KMI Poland Joint-Stock Company

Szkolna 54, 84-239 Bolszewo, Poland, e-mail: export@porta.com.pl

 facebook.com/portadoors.en  instagram.com/porta_doors/  pinterest.co.uk/porta_doors/

S.C. PORTA KMI România S.R.L.

Zona Industrială Arad Nord – Vest, Strada III, Nr. 11, 310491 Arad
www.portadoors.ro, e-mail: info_doors@porta.com.pl

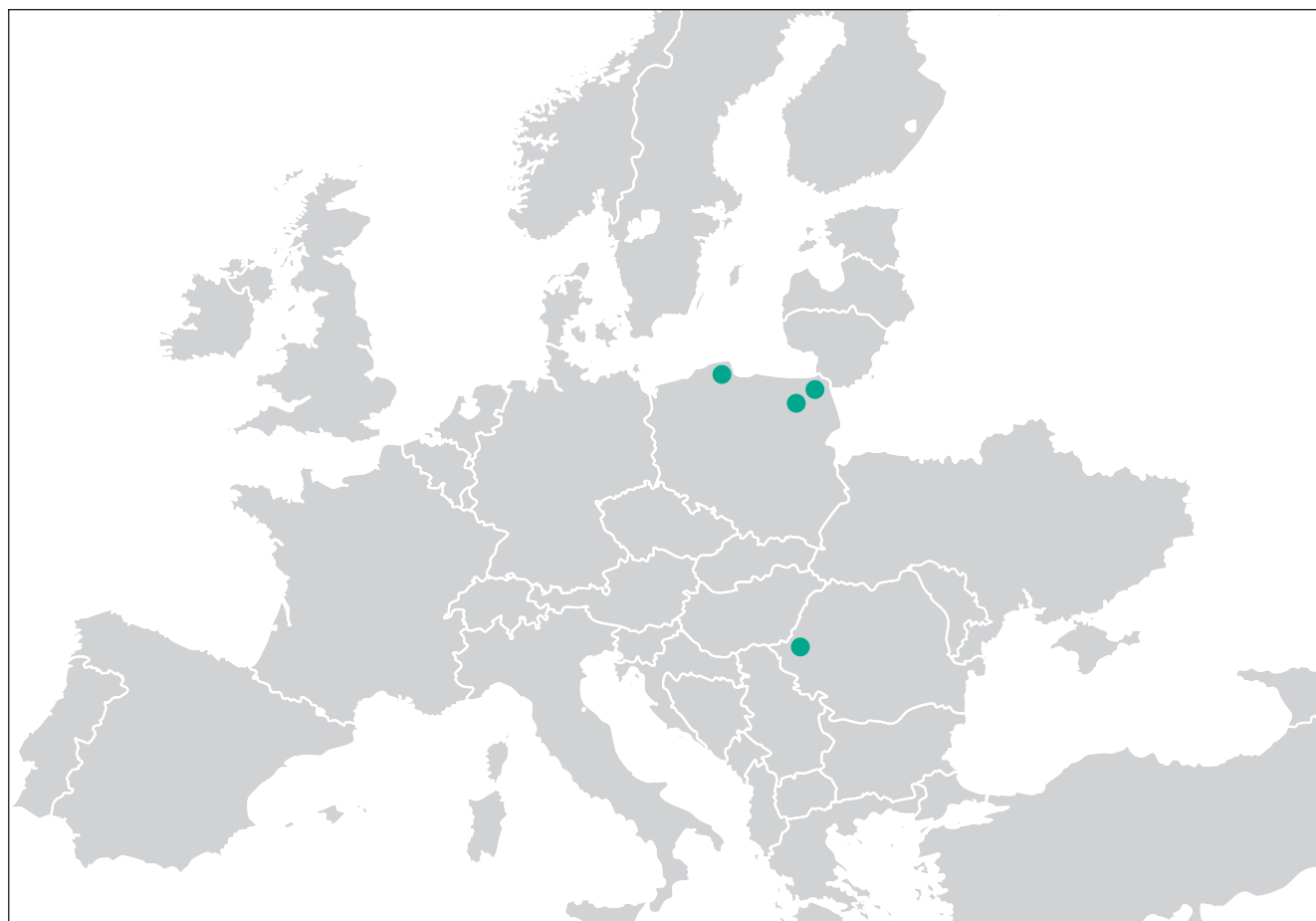

 PORTA's factories



SCAN THE QR CODE AND CHECK OUT
WHERE TO BUY PORTA DOORS

